

1958-1970

2019-2020 EDITION

# IMPALA

1958-1970 BEL-AIR/BISCAYNE

1959-1960 EL CAMINO



479-787-5575

[info@hhclassic.com](mailto:info@hhclassic.com)

[www.hhclassic.com](http://www.hhclassic.com)

12325 West Hwy 72 Bentonville  
Arkansas 72712





# Welcome to H&H Classic Parts

Thank you for requesting our 2019-2020 catalog! We've spent countless hours editing, refining, and creating the most customer friendly experience for you. Our customers are always at the forefront of everything we do, so if you have any suggestions please feel free to share your thoughts with us.

Thirty-two years ago our company, H&H, was born with a modest investment as a part-time hobby business. With hard work and dedication we've grown into an internationally recognized brand. We've established a reputation for superior customer service, fairness, and fast shipping. We will continue to take care of you, our customer, placing your needs above our own. Price is not always our first concern; quality products are more important to us. Our goal is to offer you a better product than our competition at the lowest price we can, and always with the fastest shipping in the nation.

As you may have heard, we started 2019 with a change in leadership. Our founder Herman JR stepped down and Herman III, better known as Tray, is now serving as the President and CEO of H&H. Change often brings new opportunities and challenges. H&H will always be devoted to our core business of restoration. However, we are looking to add several new product lines that will allow us to expand into more Restomods and Performance products. Stay tuned for lots of exciting news from H&H.

Again, we thank YOU; we would be nothing without our customers! Those of you that have bought from us in the past, present, and also to our future customers: if at any time we fail to meet your expectations with our service, product, or shipping, please contact us. As Herman would say, "We can't fix it, if we don't know about it."

We also encourage you to send us pictures of your projects and tag us on social media (Facebook and Instagram: @HHClassicParts). We enjoy featuring and highlighting your progress.

Happy shopping and restoring; we look forward to serving you!

Sincerely,

Herman D. "Tray" Smith III  
President CEO

Sincerely,

Herman D. Smith, Jr.  
Founder





# Policies and General Information

## Returns Information

All parts in this catalog are sold with a satisfaction guaranteed policy. **Please examine your order immediately. All shortages, incorrect items, and damages must be reported within 7 days!** If the package was damaged in shipment, save the merchandise and packaging and notify us immediately for instructions. To return an item to us, please contact us for instructions and a return authorization number. If H&H is responsible for the incorrect shipment we will reimburse the customer for their return shipping charges but under no circumstances will H&H pay for additional charges incurred by using packaging services, air shipping or accept COD shipments. For your protection, send the package by UPS or insured Parcel Post, saving the receipt until you hear from us. All Returns are subject to a 20% restocking fee. Special order items are non returnable except for warranty issues. No Returns on any items after 90 days. Any item sent back to H&H that has been opened or packaging defaced in any way will be subject to a repackaging fee. H&H reserves the right to refuse a returned item based upon its condition.

## Pricing, Terms, Conditions

H&H Classic Parts reserves the right to change all prices, terms, specifications, and other information without notice. Please call or write us if you have any questions or if you feel there is a discrepancy.

## Guarantee or Warranty

All of your parts are guaranteed for 90 days to be free of defects in materials and workmanship, unless noted within the catalog. Of course, the guarantee does not apply in the advent of any misuse, neglect, or improper installation or modification.

## Payment

We accept Visa, Mastercard, Discover, American Express, PayPal (Paypal on website orders only). There is a minimum purchase of \$10.00 on all credit card sales. Please provide the card number, expiration date, cardholder's name, and on mail orders the cardholder's signature. We also accept money orders and certified checks that are drawn on a US bank and/or financial institution. Sorry, no COD's or personal checks.

## Damage or Shipping Claims

Make certain you inspect all packages in the presence of the driver/carrier. If you receive a package that has been damaged or opened, make a claim with the driver/carrier at that time. All claims of loss, concealed damage or other destruction must be made by you with the carrier. Save all boxes and packing materials as the carrier may want to inspect it. We apologize for any inconvenience that this may cause, but this is the policy of UPS and FedEx. Any shortages not the fault of the carrier must be reported within 7 days of receiving order. No exceptions allowed.

## Back Orders

Listings in the catalog do not imply availability. It is rare that we are out of an item, however it will happen from time to time. In the event of a back order, we will cancel that item and you will need to reorder at a later date.

## Product Changes

H&H Classic Parts reserves the right to make changes and improvements in our products without incurring any liability to include these in any products previously manufactured or sold.

## Core Charges or Deposits

The purpose of core charge or deposit is to insure the return of rebuildable parts. Your deposit will be promptly refunded when we receive your complete, rebuildable core. A copy of your original purchase invoice must accompany your core. No refund will be issued for damaged, broken, disassembled, or incomplete cores. No exceptions will be allowed. Your cooperation and understanding is appreciated

## Sales Tax

Arkansas residents must include state sales tax. If you are an automotive parts business and/or you have a tax number, please include a copy of your permit with your order. To calculate sales tax you will have to contact us.

## Notice

This catalog, its wording and/or pictures are property and copyrights of H&H Classic Parts and are forbidden to be used by anyone under the penalty of law!!!

## Policies and General Information-continued

### PHONE

**479-787-5575**

Monday through Friday 8:00-5:00 (CST)

Saturday by Appointment

### FAX

**479-787-6118**

When ordering via fax, please include a phone number where you can be reached during the day.

### INTERNET

VISIT OUR WEBSITE AT:

**www.hhclassic.com**

**FOR SECURE ONLINE ORDERING**

E-MAIL US AT:

**info@hhclassic.com**

Do you have an order that you want brought to one of the events? Well, go ahead and call it in the week before the show! We will have it pulled, invoiced, and waiting for you to pick up when you get there! To have parts brought to the show please call your order in by the Friday before the event. Cruisin' the Coast and the GoodGuy's PPG National show orders must be called in THREE WEEKS BEFORE those shows.

The truck is gone for multiple weeks during those events.

### MAIL

**H&H Classic Parts**

**12325 West Highway 72**

**Bentonville, AR 72712**

Please include name, shipping address, phone number, and a detailed list of the parts being ordered. Please include a method of payment such as credit card, money order, or cashiers check (sorry, no COD's or personal checks). If you have any questions, please call 479-787-5575 and we will be happy to assist you in any way.

## US Ground Shipping Charges

Shipping charges are based upon how much you order and the size of the boxes or tubes that it will take to ship them. Our shipping charges are as follows:

| FROM      | TO             | FEE     |
|-----------|----------------|---------|
| \$0.01    | \$25.00        | \$8.95  |
| \$25.01   | \$50.00        | \$10.95 |
| \$50.01   | \$100.00       | \$14.95 |
| \$100.01  | \$200.00       | \$21.95 |
| \$200.01  | \$300.00       | \$26.95 |
| \$300.01  | \$400.00       | \$34.95 |
| \$400.01  | \$500.00       | \$42.95 |
| \$500.01  | \$600.00       | \$51.95 |
| \$600.01  | \$700.00       | \$59.95 |
| \$700.01  | \$800.00       | \$67.95 |
| \$800.01  | \$900.00       | \$75.95 |
| \$900.01  | \$1000.00      | \$83.95 |
| \$1000.01 | over \$1000.01 | \$94.95 |

Due to size and / or weight, some parts will fall into the "Oversized" shipping classification resulting in an **additional fee on top of the normal shipping rate**. Please make sure you check on our website or in our catalog to see if your parts fall into this classification to correctly estimate your shipping charges. Any item that is a "Truck Freight" classification will have to be shipped by UPS Freight. For Truck Freight items, please contact our sales department for shipping costs. **If you have any questions regarding our shipping policy, please call us at 479-787-5575 BEFORE ordering.**

| CLASSIFICATION | SYMBOL | FEE            |
|----------------|--------|----------------|
| Oversized 1    | ①      | \$8.00         |
| Oversized 2    | ②      | \$16.00        |
| Oversized 3    | ③      | \$80.00        |
| Truck Freight  | 🚚      | Call for quote |



## Air Shipping Charges

All air shipments are sent by UPS. Charges are based upon the size and weight of the box. We will have to call you back with a freight total.

## Shipping Charges to Hawaii and Alaska

All orders shipped to Hawaii, Alaska, US territories and possessions must be prepaid with a credit card and will be shipped by the best means possible.

## Shipping to Foreign Countries

All orders shipped to foreign countries must be prepaid with a credit card and will be shipped by the best means possible. Orders to foreign countries may incur customs and duty charges, customs broker and any other fees related to the importation of merchandise. All such charges are the responsibility of the recipient.



**Allow 2-3 Weeks for delivery on all AC systems.**

### GEN-IV SURE-FIT SYSTEMS

The Generator-IV is Vintage Air's most powerful and intelligent climate control system. Generator-IV systems utilize Vintage Air's exclusive fully electronic microprocessor control servomotor drives to eliminate cables or vacuum connections. Separate high capacity copper parallel-flow heat coil and aluminum plate and fin cooling coils provide outstanding performance and instant temperature adjustments. The new 1959-60 Chevy Full-Size SureFit system includes Vintage Air's exclusive Electronic Cable Converters which adapt to your factory 4-lever Deluxe controls for electronic operation. The 2-lever kits includes a 3-knob under-dash control pod for electronic operation. Additional features include variable blower speed and dash/floor/defrost blend. SureFit Systems are engineered specifically for each vehicle application and require minimal alteration to the vehicle for installation. You can also upgrade each unit to a polished compressor (part #3645) and chrome drier (part# 3646).

**NOTES:**

Some installations may require additional engine pulleys not included with kits. You must provide pulleys, v-belts, heater hose, and refrigerant. Vintage Air recommends using their heavy duty fan blade and a fan shroud.

The 1959-60 4-lever kits include the Vintage Air exclusive Electronic Cable Converters which adapt to your factory 4-lever Deluxe controls for electronic operation.

| Part # | Year  | Model                        | Part                                   | Price       |
|--------|-------|------------------------------|--|-------------|
| 15194★ | 59-60 | Evaporator Kit               | Generator-IV Kits for 4-Lever Controls | 835.95 Kit  |
| 12929★ | 59-60 | Small Block Short Water Pump | Generator-IV Kits for 4-Lever Controls | 1480.95 Kit |
| 15195★ | 59-60 | Small Block Long Water Pump  | Generator-IV Kits for 4-Lever Controls | 1480.95 Kit |
| 15196★ | 59-60 | Big Block Short Water Pump   | Generator-IV Kits for 4-Lever Controls | 1480.95 Kit |
| 15197★ | 59-60 | Big Block Long Water Pump    | Generator-IV Kits for 4-Lever Controls | 1480.95 Kit |
| 15548★ | 59-60 | w/348                        | Generator-IV Kits for 4-Lever Controls | 1480.95 Kit |



The 1959-60 2-lever kits include a 3-knob under-dash control pod for electronic operation.

| Part # | Year  | Model                        | Part                                   | Price       |
|--------|-------|------------------------------|--|-------------|
| 15190★ | 59-60 | Evaporator Kit               | Generator-IV Kits for 2-Lever Controls | 835.95 Kit  |
| 12928★ | 59-60 | Small Block Short Water Pump | Generator-IV Kits for 2-Lever Controls | 1480.95 Kit |
| 15191★ | 59-60 | Small Block Long Water Pump  | Generator-IV Kits for 2-Lever Controls | 1480.95 Kit |
| 15192★ | 59-60 | Big Block Short Water Pump   | Generator-IV Kits for 2-Lever Controls | 1480.95 Kit |
| 15193★ | 59-60 | Big Block Long Water Pump    | Generator-IV Kits for 2-Lever Controls | 1480.95 Kit |
| 15547★ | 59-60 | w/348                        | Generator-IV Kits for 2-Lever Controls | 1480.95 Kit |

★ = special order non-stocking item.

# Air Conditioning



15549

1961-62 Vintage Air Generator-Iv Systems.

| Part # | Year  | Model                                   | Part                        | Price       |
|--------|-------|---|-----------------------------|-------------|
| 15549★ | 61-62 | w/o Factory AC w/Small Block Short Pump | Generator-IV AC System      | 1480.95 Ea. |
| 15550★ | 61-62 | w/o Factory AC w/Small Block Long Pump  | Generator-IV AC System      | 1480.95 Ea. |
| 15551★ | 61-62 | w/o Factory AC w/Big Block Short Pump   | Generator-IV AC System      | 1480.95 Ea. |
| 15552★ | 61-62 | w/o Factory AC w/Big Block Long Pump    | Generator-IV AC System      | 1480.95 Ea. |
| 15553★ | 61-62 | w/o Factory AC w/348/409                | Generator-IV AC System      | 1480.95 Ea. |
| 15554★ | 61-62 | w/Factory AC w/Small Block Short Pump   | Generator-IV AC System      | 1480.95 Ea. |
| 15555★ | 61-62 | w/Factory AC w/Small Block Long Pump    | Generator-IV AC System      | 1480.95 Ea. |
| 15556★ | 61-62 | w/Factory AC w/Big Block Short Pump     | Generator-IV AC System      | 1480.95 Ea. |
| 15557★ | 61-62 | w/Factory AC w/Big Block Long Pump      | Generator-IV AC System      | 1480.95 Ea. |
| 15558★ | 61-62 | w/Factory AC w/348/409                  | Generator-IV AC System      | 1480.95 Ea. |
| 15889★ | 61-62 | w/o Factory Air                         | Generator-IV Evaporator Kit | 835.95 Kit  |
| 15890★ | 61-62 | w/Factory Air                           | Generator-IV Evaporator Kit | 835.95 Kit  |



15549

1963 Vintage Air Generator-Iv Systems.

| Part # | Year | Model                                    | Part                        | Price       |
|--------|------|--|-----------------------------|-------------|
| 15589★ | 63   | W/O Factory Air W/Small Block Short Pump | Generator-Iv AC System      | 1480.95 Ea. |
| 15590★ | 63   | W/O Factory Air W/Small Block Long Pump  | Generator-Iv AC System      | 1480.95 Ea. |
| 15591★ | 63   | W/O Factory Air W/Big Block Short Pump   | Generator-Iv AC System      | 1480.95 Ea. |
| 15592★ | 63   | W/O Factory Air W/Big Block Long Pump    | Generator-Iv AC System      | 1480.95 Ea. |
| 15593★ | 63   | W/O Factory Air W/409                    | Generator-Iv AC System      | 1480.95 Ea. |
| 15594★ | 63   | W/Factory Air W/Small Block Short Pump   | Generator-Iv AC System      | 1480.95 Ea. |
| 15595★ | 63   | W/Factory Air W/Small Block Long Pump    | Generator-Iv AC System      | 1480.95 Ea. |
| 15596★ | 63   | W/Factory Air W/Big Block Short Pump     | Generator-Iv AC System      | 1480.95 Ea. |
| 15597★ | 63   | W/Factory Air W/Big Block Long Pump      | Generator-Iv AC System      | 1480.95 Ea. |
| 15598★ | 63   | W/Factory Air W/409                      | Generator-Iv AC System      | 1480.95 Ea. |
| 15599★ | 63   | W/O Factory Air                          | Generator-Iv Evaporator Kit | 835.95 Kit  |
| 15600★ | 63   | W/Factory Air                            | Generator-Iv Evaporator Kit | 835.95 Kit  |

★ = special order non-stocking item.

# Air Conditioning

## 1964 VINTAGE AIR GEN-IV SYSTEMS

| Part # | Year | Model                                    | Part                        | Price       |
|--------|------|--|-----------------------------|-------------|
| 15601★ | 64   | w/o Factory Air w/Small Block Short Pump | Generator-Iv AC System      | 1480.95 Ea. |
| 15602★ | 64   | w/o Factory Air w/Small Block Long Pump  | Generator-Iv AC System      | 1480.95 Ea. |
| 15603★ | 64   | w/o Factory Air w/Big Block Short Pump   | Generator-Iv AC System      | 1480.95 Ea. |
| 15604★ | 64   | w/o Factory Air w/Big Block Long Pump    | Generator-Iv AC System      | 1480.95 Ea. |
| 15605★ | 64   | w/o Factory Air w/409                    | Generator-Iv AC System      | 1480.95 Ea. |
| 15606★ | 64   | w/Factory Air w/Small Block Short Pump   | Generator-Iv AC System      | 1480.95 Ea. |
| 15607★ | 64   | w/Factory Air w/Small Block Long Pump    | Generator-Iv AC System      | 1480.95 Ea. |
| 15608★ | 64   | w/Factory Air w/Big Block Short Pump     | Generator-Iv AC System      | 1480.95 Ea. |
| 15609★ | 64   | w/Factory Air w/Big Block Long Pump      | Generator-Iv AC System      | 1480.95 Ea. |
| 15610★ | 64   | w/Factory Air w/409                      | Generator-Iv AC System      | 1480.95 Ea. |
| 15611★ | 64   | w/o Factory Air                          | Generator-Iv Evaporator Kit | 835.95 Kit  |
| 15612★ | 64   | w/Factory Air                            | Generator-Iv Evaporator Kit | 835.95 Kit  |

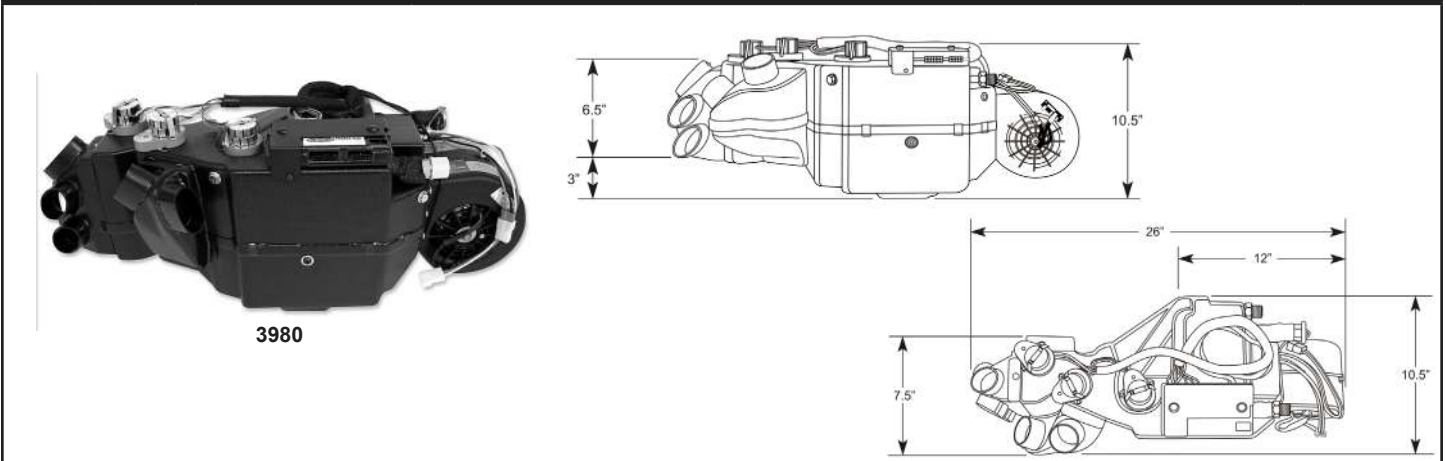

## GEN-IV MAGNUM







Fully electronic with computer controlled coil temp monitor. Separate heat and cool coils with aluminum plate AC coil and brass parallel flow heater coil. In full AC, air bypasses heater core for increased air flow. Features a blend air door for instant temp adjustment. Infinite air blend for dash/floor and defrost/floor. Has positive shut-off solenoid operated heater control valve in full AC.

| Part # | Year  | Model | Part          | Price      |
|--------|-------|-------|---------------|------------|
| 3980★  | 58-70 | ALL   | GEN-IV MAGNUM | 699.95 Ea. |

### GEN-IV SURE-FIT KITS UPGRADE OPTIONS

|  | <b>3645</b> |  | <b>3646</b>                        |           |
|---|-------------|---|------------------------------------|-----------|
| Part #  | Year        | Model   | Part                               | Price     |
| 3645★   | 59-64       | All   | Polished Compressor Upgrade Option | 79.95 Ea. |
| 3646★   | 59-64       | All   | Chrome Drier Upgrade Option        | 45.95 Ea. |

### COMPRESSORS

|   |  |  |  |
|--|---|---|---|
| <b>3662</b>  | <b>3663</b>   | <b>3664</b>   | <b>3665</b>   |
| <p>This compressor is recommended for all Vintage Air systems. It pumps 8.4 cubic inches per revolution with a maximum 6000 sustained RPM range. Fits all Vintage Air and Alan Grove brackets. Available in standard finish or polished.</p> |   |   |   |
| Part #   | Model   | Price   |   |
| 3662   | Standard Compressor w/Dual Groove Pulley  | 199.95 Ea.  |   |
| 3663   | Polished Compressor w/Dual Groove Pulley  | 249.95 Ea.  |   |
| 3664★  | Standard Compressor w/Serpentine Pulley   | 199.95 Ea.  |   |
| 3665★  | Polished Compressor w/Serpentine Pulley   | 249.95 Ea.  |   |

**Allow 2-3 Weeks for delivery on all AC systems.**

**WARNING: When using a crate or salvage motor, make sure the compressor isn't a variable speed or output-type. These will not work with any Vintage Air system. These are most common on LS motors.**

★ = special order non-stocking item.

# Air Conditioning

## MARK-IV AC SYSTEM



This exact reproduction has a steel case built from the original specs. It includes mounting brackets, built-in controls.

| Part # | Model | Part                         | Price      |
|--------|-------|------------------------------|------------|
| 3909★  | All   | MARK-IV Under Dash AC System | 299.95 Ea. |

## BULK HEADS



3683



3684



3685



3686



3687

Allows one-man tightening of fittings and reduces the possibility of scratching your paint.

| Part # | Model                             | Price     |
|--------|-----------------------------------|-----------|
| 3683   | Square Bulk Head w/6-10 Fittings  | 65.95 Ea. |
| 3684★  | Square Bulk Head w/8-10 Fittings  | 65.95 Ea. |
| 3685   | Diamond Bulk Head w/6-10 Fittings | 65.95 Ea. |
| 3686★  | Diamond Bulk Head w/8-10 Fittings | 65.95 Ea. |
| 3687   | Inline Bulk Head w/6-10 Fittings  | 65.95 Ea. |

## DRIERS



3673



3676

Comes in either standard black or chrome. Compact size 2.5" x 6". Threaded port trinary or binary switch installation. Comes sealed and pre-charged with nitrogen.

| Part # | Model                              | Part                            | Price     |
|--------|------------------------------------|---------------------------------|-----------|
| 3672   | w/o Mounting Bracket               | Standard Drier                  | 35.95 Ea. |
| 3673★  | w/o Bracket w/Binary Switch        | Standard Drier                  | 39.95 Ea. |
| 3674★  | w/o Bracket w/Trinary Switch       | Standard Drier                  | 59.95 Ea. |
| 3675   | w/Standard Drier                   | Standard Drier Mounting Bracket | 1.50 Ea.  |
| 3676   | w/Mounting Bracket                 | Chrome Drier                    | 69.95 Ea. |
| 3677★  | w/Mounting Bracket w/Binary Switch | Chrome Drier                    | 75.95 Ea. |
| 3678★  | w/Bracket w/Trinary Switch         | Chrome Drier                    | 94.95 Ea. |

## VINTAGE AIR CONDENSER ASSEMBLIES



Representative image. Actual product may vary in appearance.



This SuperFlow condenser design was pioneered by Vintage Air to provide leading-edge technology and superior performance with today's 134a refrigerants. The importance of this unique new micro tube design and its improved refrigerant flow cannot be overemphasized. By providing increased refrigerant contact with the micro tube walls and multiple passes per circuit for low restriction pathway, SuperFlow condensers provide up to 40% more capacity than comparably sized old-style tube-and-fin condensers. WILL NOT WORK WITH ORIGINAL AC SYSTEM.

| Part # | Year  | Model | Part               | Price      |
|--------|-------|-------|--------------------|------------|
| 16235★ | 59-60 | All   | Condenser Pack Kit | 299.95 Kit |
| 16236★ | 61-63 | All   | Condenser Pack Kit | 299.95 Kit |
| 16237★ | 64    | All   | Condenser Pack Kit | 299.95 Kit |

## TITE FIT COMPRESSOR LINE KITS



3681

Creates compact and professional looking refrigerant line routing down and close to engine. Proline Tite Fit nuts built onto lines.

| Part # | Part                                  | Price     |
|--------|---------------------------------------|-----------|
| 3681★  | Tite Fit Compressor Line Kit          | 59.95 Ea. |
| 3682★  | Polished Tite Fit Compressor Line Kit | 79.95 Ea. |

## AC VENT LOUVERS



3655



3657



4059



4060



4061

These standard louvers are quality built to complement your vehicle and cooling system.

| Part # | Model | Part                          | Price     |
|--------|-------|-------------------------------|-----------|
| 3655★  | All   | Round Louver w/Billet Bezel   | 35.95 Ea. |
| 3657★  | All   | Venturi Alumin Louver         | 70.95 Ea. |
| 4059★  | All   | Streamline 4" Louver          | 50.95 Ea. |
| 4060★  | All   | Streamline 4.875" Louver      | 50.95 Ea. |
| 4061★  | All   | Under Dash Mount Round Louver | 14.95 Ea. |

★ = special order non-stocking item.

# Air Conditioning

## GEN-IV MAGNUM CONTROLS



3981



3982



3983



4176



4186



4187

A must for your Generator-IV Magnum upgrade!

| Part # | Part                                     | Price      |
|--------|--|------------|
| 3981★  | Polished Horizontal Control              | 199.95 Ea. |
| 3982★  | Polished Vertical Control                | 199.95 Ea. |
| 3983★  | Anodized Horizontal Control              | 209.95 Ea. |
| 3984★  | Anodized Vertical Control                | 209.95 Ea. |
| 4176★  | Rotary Under Dash Pod                    | 50.95 Ea.  |
| 4186★  | Proline Panel w/Polished Bezel and Knobs | 199.95 Ea. |
| 4187★  | Proline Panel w/Black Bezel and Knobs    | 209.95 Ea. |

## HOSE KITS



3679



3680

All Vintage Air line kits use barrier type refrigerant line for use with HFC-134a refrigerant. Includes adequate hose length to connect complete system, all O-ring fittings and crimp ferrules. 134A systems include fittings with service ports. Set includes: 10ft of #6 line, 6ft of #8 line, 9ft of 10# lines, and standard drier. Drier not included on Part #3680.

| Part # | Model           | Part  | Price      |
|--------|-----------------|---|------------|
| 3679   | All             | Universal Hose Kit w/Standard Drier                                 | 129.95 Ea. |
| 3680   | All             | Universal Hose Kit Only   | 124.95 Ea. |
| 4389★  | w/GM compressor | Compressor Line Adapters Fits Any Using Vintage Air w/GM Compressor | 45.95 Pair |

## AC & HEATER DUCT HOSES



4350



4352

| Part # | Model      | Part                        | Price     |
|--------|------------|-----------------------------|-----------|
| 4350   | All 2"     | Plastic AC/Heater           | 15.95 Ea. |
| 4351   | All 2-1/4" | Cloth AC/Heater Duct Hose   | 29.95 Ea. |
| 4352   | All 2-1/2" | Plastic AC/Heater Duct Hose | 15.95 Ea. |
| 4353   | All 2-3/4" | Plastic AC/Heater Duct Hose | 16.95 Ea. |
| 4354   | All 3"     | Plastic AC/Heater Duct Hose | 16.95 Ea. |

★ = special order non-stocking item.

# Air Conditioning

## What kind of water pump do I have?

### SMALL BLOCK WITH SHORT WATER PUMP

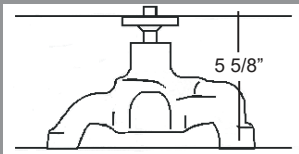

### BIG BLOCK WITH SHORT WATER PUMP

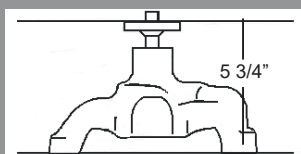

### SMALL BLOCK WITH LONG WATER PUMP

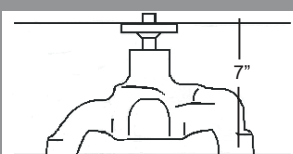

### BIG BLOCK WITH LONG WATER PUMP

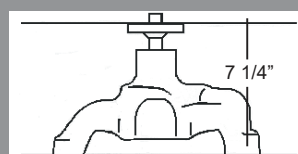

Chevrolet used many different water pumps throughout their history. Please take the time and make sure that you identify which water pump you have so that you will be able to order the correct AC system or correct brackets and pulleys.

## BRACKETS FOR 6-CYLINDER



3886 58-62 ALTERNATOR BRACKET 65.95 Ea.  
3887 58-62 ALTERNATOR/COMPRESSOR BRACKET 159.95 Set



## BRACKETS FOR SMALL BLOCK

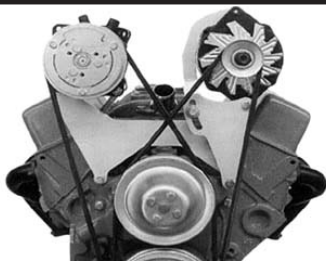

FRONT VIEW



REAR VIEW

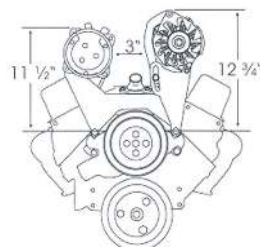

These brackets bolt to the top water pump and the two front intake bolts. They may be used individually or as a pair. Will clear tall valve covers.

| Part #                                   | Model                       | Price      |
|--|-----------------------------|------------|
| <b>SMALL BLOCK WITH SHORT WATER PUMP</b> |                             |            |
| 3605                                     | Compressor Mounting Bracket | 105.95 Ea. |
| 3606                                     | Alternator Mounting Bracket | 95.95 Ea.  |
| <b>SMALL BLOCK WITH LONG WATER PUMP</b>  |                             |            |
| 3616                                     | Compressor Mounting Bracket | 105.95 Ea. |
| 3617                                     | Alternator Mounting Bracket | 99.95 Ea.  |

## BRACKETS FOR SMALL BLOCK



FRONT VIEW

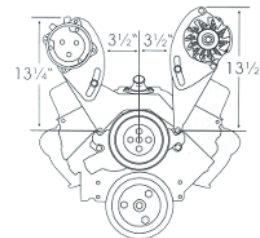

Designed for use in applications that require added clearance for tri-power carbs and dual quad carbs. Bolt to top water pump and the two front intake bolts. Alternator bracket works well with intake mounted oil filler tube and offset thermostat housings. Will clear up to 4 1/2" tall valve covers.

| Part #                                   | Model                       | Price      |
|--|-----------------------------|------------|
| <b>SMALL BLOCK WITH SHORT WATER PUMP</b> |                             |            |
| 3607                                     | Compressor Mounting Bracket | 115.95 Ea. |
| 3608                                     | Alternator Mounting Bracket | 99.95 Ea.  |
| <b>SMALL BLOCK WITH LONG WATER PUMP</b>  |                             |            |
| 3618                                     | Compressor Mounting Bracket | 105.95 Ea. |
| 3619                                     | Alternator Mounting Bracket | 99.95 Ea.  |

# Air Conditioning

## BRACKETS FOR SMALL BLOCK



Front View

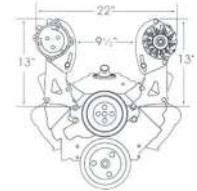

A very versatile bracket system. Works with most induction systems. Will clear multiple carbs and most fuel injection. The alternator bracket will fit all 1969 and newer heads except Vortec. The AC bracket Fits all GM aluminum heads and may be used on 1969-1986 cast iron heads by drilling and tapping one hole for the upper mounting point. Will clear up to 3" tall center bolt valve covers when used on 1987 and later heads. Will clear up to 3 3/4" tall valve covers when used on 1986 and earlier heads.

| Part #                                   | Model                       | Price      |
|--|-----------------------------|------------|
| <b>SMALL BLOCK WITH SHORT WATER PUMP</b> |                             |            |
| 3609                                     | Compressor Mounting Bracket | 105.95 Ea. |
| 3610                                     | Alternator Mounting Bracket | 105.95 Ea. |
| <b>SMALL BLOCK WITH LONG WATER PUMP</b>  |                             |            |
| 3620                                     | Compressor Mounting Bracket | 105.95 Ea. |
| 3621                                     | Alternator Mounting Bracket | 105.95 Ea. |

## BRACKETS FOR SMALL BLOCK



Front View

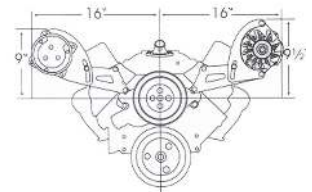

Designed for cars with low hood clearance: Vettes, Camaros, etc. These brackets also work great on most vehicles with a wide engine compartment: trucks, 50's and 60's cars, etc. These brackets bolt to the head and top water pump bolt holes. The AC compressor bracket Fits all GM aluminum heads and may be used on 1969 through 1986 cast iron heads by drilling and tapping one hole for the upper mounting point.

| Part #                                   | Model                       | Price      |
|--|-----------------------------|------------|
| <b>SMALL BLOCK WITH SHORT WATER PUMP</b> |                             |            |
| 3611                                     | Compressor Mounting Bracket | 105.95 Ea. |
| 3612                                     | Alternator Mounting Bracket | 105.95 Ea. |
| <b>SMALL BLOCK WITH LONG WATER PUMP</b>  |                             |            |
| 3622                                     | Compressor Mounting Bracket | 105.95 Ea. |
| 3623                                     | Alternator Mounting Bracket | 105.95 Ea. |

## BRACKETS FOR SMALL BLOCK



Front View

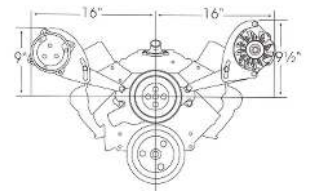

These brackets bolt to the water pump and exhaust. No holes are needed in the head. Furnished to fit with stock exhaust manifolds and most headers. If used with headers, the front tube must turn down enough to allow access to the bolt hold in front of the second pipe.

| Part #                                   | Model                       | Price      |
|--|-----------------------------|------------|
| <b>SMALL BLOCK WITH SHORT WATER PUMP</b> |                             |            |
| 3613                                     | Compressor Mounting Bracket | 105.95 Ea. |
| 3614                                     | Alternator Mounting Bracket | 105.95 Ea. |
| <b>SMALL BLOCK WITH LONG WATER PUMP</b>  |                             |            |
| 3625                                     | Compressor Mounting Bracket | 105.95 Ea. |
| 3626                                     | Alternator Mounting Bracket | 105.95 Ea. |

# Air Conditioning

## BRACKETS FOR SMALL BLOCK



Front View

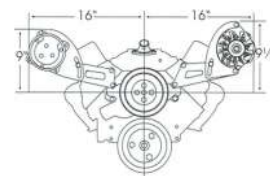
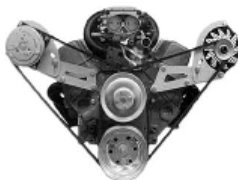

A very versatile bracket system. Works well with most induction systems. Will clear multiple carbs and most fuel injection. The alternator bracket will fit all 1967 and newer heads except Vortec. The AC bracket Fits all GM aluminum heads and may be used on 1969-1986 cast iron heads by drilling and tapping one hole for the upper mounting point. Will clear up to 3" tall center bolt valve covers when used on 1987 and later heads. Will clear up to 3 3/4" tall valve covers when used on 1986 and earlier heads.

| Part #                                   | Model                       | Price      |
|--|-----------------------------|------------|
| <b>SMALL BLOCK WITH SHORT WATER PUMP</b> |                             |            |
| 3615                                     | Compressor Mounting Bracket | 105.95 Ea. |
| 3612                                     | Alternator Mounting Bracket | 105.95 Ea. |
| <b>SMALL BLOCK WITH LONG WATER PUMP</b>  |                             |            |
| 3624                                     | Compressor Mounting Bracket | 105.95 Ea. |
| 3623                                     | Alternator Mounting Bracket | 105.95 Ea. |

## BRACKETS FOR BIG BLOCK



Front View

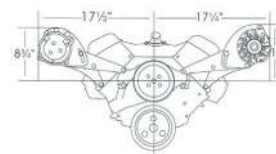

Engineered for low hood applications. Works great on any vehicle with a wide engine compartment: trucks, 50's and 60's cars, etc. Bolts to the heads and water pump.

| Part #                                 | Model                       | Price      |
|--|-----------------------------|------------|
| <b>BIG BLOCK WITH SHORT WATER PUMP</b> |                             |            |
| 3627                                   | Compressor Mounting Bracket | 105.95 Ea. |
| 3628                                   | Alternator Mounting Bracket | 105.95 Ea. |
| <b>BIG BLOCK WITH LONG WATER PUMP</b>  |                             |            |
| 3629                                   | Compressor Mounting Bracket | 105.95 Ea. |
| 3630                                   | Alternator Mounting Bracket | 105.95 Ea. |

### 348/409 BRACKETS

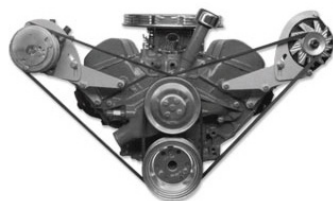

15337

These brackets bolt to heads and will work with readily available small block short water pump pulleys. These brackets are designed for the Sanderson 508 aftermarket compressor. Relocation of the battery will be required for 1958 applications.

| Part # | Year  | Model | Part                  | Price      |
|--------|-------|-------|-----------------------|------------|
| 15337  | 58-61 | w/348 | AC Compressor Bracket | 119.95 Ea. |
| 15337  | 62-65 | w/409 | AC Compressor Bracket | 119.95 Ea. |
| 15338  | 58-61 | w/348 | Alternator Bracket    | 119.95 Ea. |
| 15338  | 62-65 | w/409 | Alternator Bracket    | 119.95 Ea. |

☆ = special order non-stocking item.

# Air Conditioning

## FRONT RUNNER ENGINE DRIVE SYSTEMS



- Exclusive front runner spring tensioner provides continuous SAE-SPEC static and dynamic belt tensioning for OEM quality belt life
- Exclusive block-mounted design allows any deck height/cylinder head combination. Uses no head or intake mounting bolts like conventional brackets.
- Super rigid truss-architecture design CNC machined from 6061-T billet aluminum. Available in machined or gray anodized finish.
- Engineered to clear most GM and aftermarket tuned port fuel injection systems.
- Exclusive fixed-position component mounting creates a super compact package within the basic engine size envelope. Fits into extremely tight chassis configurations.
- Uses exclusive new Vintage Air Tite-Fit Line/Compact Compressor Package.
- Exclusive precision machined hard-coated aluminum pulleys reduce weight and wear like steel.
- Pulley sized engineered and matched for optimum component speeds.
- Uses compact GM Type II power steering pump and modified GM 140 amp alternator.

Small Block Version



LS Version



### FRONT RUNNER BRITE KITS

Includes machined bracket, chrome pulleys, polished compressor with hardlines, polished 140-amp alternator, polished compressor and tensioner covers, extended heater hose nipple, hardware, and belt.

| Part #                                   | Model                    | Price       |
|--|--------------------------|-------------|
| <b>SMALL BLOCK WITH SHORT WATER PUMP</b> |                          |             |
| 3633★                                    | w/o Power Steering       | 2075.95 Kit |
| 3634★                                    | w/Power Steering         | 2265.95 Kit |
| <b>BIG BLOCK</b>                         |                          |             |
| 3641★                                    | w/o Power Steering       | 2190.95 Kit |
| 3642★                                    | w/Power Steering         | 2380.95 Kit |
| <b>LS ENGINES</b>                        |                          |             |
| 3637★                                    | w/Power Steering         | 2895.95 Kit |
| 3638★                                    | w/o Power Steering       | 2675.95 Kit |
| 3996★                                    | w/Power Steering (LS7)   | 2895.95 Kit |
| 3997★                                    | w/o Power Steering (LS7) | 2675.95 Kit |

### FRONT RUNNER ANODIZED KITS

Includes anodized bracket, hard coat pulleys, standard finish compressor with hardlines, natural finish, 140-amp alternator, extended heater hose nipple, hardware, and belt.

| Part #                                   | Model                    | Price       |
|--|--------------------------|-------------|
| <b>SMALL BLOCK WITH SHORT WATER PUMP</b> |                          |             |
| 3635★                                    | w/o Power Steering       | 2025.95 Kit |
| 3636★                                    | w/Power Steering         | 2215.95 Kit |
| <b>BIG BLOCK</b>                         |                          |             |
| 3643★                                    | w/o Power Steering       | 2140.95 Kit |
| 3644★                                    | w/Power Steering         | 2165.95 Kit |
| <b>LS ENGINES</b>                        |                          |             |
| 3639★                                    | w/Power Steering         | 2795.95 Kit |
| 3640★                                    | w/o Power Steering       | 2575.95 Kit |
| 3998★                                    | w/Power Steering (LS7)   | 2795.95 Kit |
| 3999★                                    | w/o Power Steering (LS7) | 2575.95 Kit |

### FRONT RUNNER POWER STEERING PUMPS AND ACCESSORIES



Manufactured to be a perfect fit for a flawless restoration!

| Part # | Model                | Part  | Price      |
|--------|----------------------|---|------------|
| 3775★  | w/Front Runner       | Aluminum Pump w/Integral Plastic Reservoir          | 245.95 Ea. |
| 3776★  | w/Front Runner       | Polished Aluminum Pump w/Integral Plastic Reservoir | 259.95 Ea. |
| 3777★  | w/Front Runner       | Aluminum Pump for Use w/Remote Reservoir            | 169.95 Ea. |
| 3778★  | w/Front Runner       | Polished Aluminum Pump for Use w/Remote Reservoir   | 239.95 Ea. |
| 3779★  | w/Front Runner       | Remote Power Steering Pump Reservoir                | 89.95 Ea.  |
| 3781   | w/Front Runner       | Banjo Pressure Fitting                              | 29.95 Ea.  |
| 3787   | w/Interior Reservoir | Banjo Fitting & Line                                | 79.95 Ea.  |
| 3780   | w/Front Runner       | Braided PS Hose Kit                                 | 195.95 Set |

★ = special order non-stocking item.

## Air Conditioning / Accelerator

### AC VENT BALL



| Part # | Year  | Model | Part                | Price     |
|--------|-------|-------|---------------------|-----------|
| 5000   | 65-68 | All   | AC Vent Ball Chrome | 12.95 Ea. |

### AC VENT SEALS



| Part # | Year  | Model | Part            | Price     |
|--------|-------|-------|-----------------|-----------|
| 5001   | 65-68 | w/AC  | Vent Ball Seals | 10.95 Set |

### AC HOSE PARTS



| Part # | Year  | Model | Part                   | Price     |
|--------|-------|-------|------------------------|-----------|
| 15831  | 67-68 | w/AC  | AC Hose Fender Grommet | 28.95 Ea. |

### AC DASH VENT ASSEMBLY



| Part # | Year | Model | Part                  | Price     |
|--------|------|-------|-----------------------|-----------|
| 15293  | 69   | ALL   | AC Dash Vent Assembly | 23.95 Ea. |

### A-FRAME DUST SHIELDS



10000



10004



10006

| Part # | Year  | Model | Part                 | Price      |
|--------|-------|-------|----------------------|------------|
| 10000  | 58    | All   | A-Frame Dust Shields | 11.95 Pair |
| 10001  | 59    | All   | A-Frame Dust Shields | 11.95 Pair |
| 10002  | 60    | All   | A-Frame Dust Shields | 11.95 Pair |
| 10003  | 61    | All   | A-Frame Dust Shields | 11.95 Pair |
| 10004  | 62-64 | All   | A-Frame Dust Shields | 11.95 Pair |
| 10005  | 65    | All   | A-Frame Dust Shields | 11.95 Pair |
| 10006  | 66    | All   | A-Frame Dust Shields | 11.95 Pair |
| 10007  | 67    | All   | A-Frame Dust Shields | 11.95 Pair |
| 10008  | 68-69 | All   | A-Frame Dust Shields | 16.95 Pair |
| 10009  | 70-72 | All   | A-Frame Dust Shields | 17.95 Pair |

### AC COMPRESSOR BRACKETS



| Part # | Year  | Model          | Part         | Price     |
|--------|-------|----------------|--------------|-----------|
| 10011  | 64-68 | V8 Small Block | Rear Bracket | 14.95 Ea. |

### AC COMPRESSOR SWITCHES

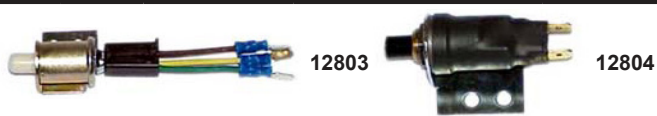

| Part # | Year  | Model | Part                 | Price     |
|--------|-------|-------|----------------------|-----------|
| 12803  | 63-64 | All   | AC Compressor Switch | 59.95 Ea. |
| 12804  | 65-68 | All   | AC Compressor Switch | 49.95 Ea. |

### ACCELERATOR PEDALS & TRIM



| Part # | Year  | Model | Part                   | Price     |
|--------|-------|-------|------------------------|-----------|
| 10019  | 58-64 | All   | Accelerator Pedal      | 20.95 Ea. |
| 5023   | 65-70 | All   | Accelerator Pedal      | 13.95 Ea. |
| 5025   | 65-70 | All   | Accelerator Pedal Trim | 14.95 Ea. |

### ACCELERATOR PEDAL PARTS



| Part # | Year  | Model | Part                          | Price     |
|--------|-------|-------|-------------------------------|-----------|
| 10020  | 58    | All   | Accelerator Pedal Rod Boot    | 12.95 Ea. |
| 6550   | 58-70 | All   | Accelerator Pedal Floor Stud  | 2.50 Ea.  |
| 378    | 58-69 | All   | Pedal Firewall Bushings       | 5.95 Ea.  |
| 16130  | 61-64 | All   | Accelerator Pedal Linkage     | 45.95 Ea. |
| 15296  | 65-70 | All   | Accelerator Pedal Rod Support | 23.95 Ea. |
| 16294  | 70-75 | All   | Accelerator Cable Retainer    | 5.95 Ea.  |

# Air Cleaner / Alternator / Armrests

## AIR CLEANER RODS



| Part # | Year  | Model             | Part            | Price     |
|--------|-------|-------------------|-----------------|-----------|
| 1812   | 58    | V8 4-Barrel       | Air Cleaner Rod | 7.95 Ea.  |
| 10021  | 58    | V8 Fuel Injection | Air Cleaner Rod | 7.95 Ea.  |
| 10022  | 62-64 | 409 2x4-Barrel    | Air Cleaner Rod | 12.95 Set |

## AIR CLEANER ASSEMBLIES



| Part # | Year  | Model             | Part                                | Price      |
|--------|-------|-------------------|-------------------------------------|------------|
| 15814  | 59-64 | 283/327 4-BBL     | Air Cleaner Assembly                | 179.95 Ea. |
| 15815  | 66-67 | Small Block 4-BBL | Air Cleaner Assembly                | 159.95 Ea. |
| 15655  | 67-69 | w/427             | Air Cleaner Assembly (Open Element) | 99.95 Ea.  |

## ALTERNATOR BRACKETS (FACTORY)



| Part # | Year  | Model       | Part                           | Price     |
|--------|-------|-------------|--------------------------------|-----------|
| 15648  | 69-72 | Small Block | Upper Alternator Bracket       | 45.95 Ea. |
| 15649  | 69-72 | Small Block | Lower Alternator Bracket       | 13.95 Ea. |
| 15650  | 69-72 | Small Block | Rear Alternator Brace & Spacer | 15.95 Ea. |
| 15651  | 69-72 | Small Block | Alternator Bracket Kit         | 79.95 Kit |

## ARMREST BASES



| Part # | Year  | Model     | Part                | Price      |
|--------|-------|-----------|---------------------|------------|
| 10049  | 62-64 | Impala/SS | Front Armrest Bases | 45.95 Pair |
| 15478  | 62-64 | Belair    | Front Armrest Bases | 31.95 Pair |
| 10050  | 65-67 | Impala/SS | Front Armrest Bases | 45.95 Pair |
| 10051  | 65-67 | Belair    | Front Armrest Bases | 30.95 Pair |

## ARMREST PADS



| Part # | Year  | Model     | Part                     | Price      |
|--------|-------|-----------|--------------------------|------------|
| 15714  | 62-64 | Impala/SS | Armrest Pads Aqua        | 79.95 Pair |
| 15715  | 62-64 | Impala/SS | Armrest Pads Black       | 79.95 Pair |
| 15716  | 62-64 | Impala/SS | Armrest Pads Light Blue  | 79.95 Pair |
| 15717  | 62-64 | Impala/SS | Armrest Pads Fawn        | 79.95 Pair |
| 15718  | 62-64 | Impala/SS | Armrest Pads Light Fawn  | 79.95 Pair |
| 15719  | 62-64 | Impala/SS | Armrest Pads Bright Red  | 79.95 Pair |
| 15720  | 62-64 | Impala/SS | Armrest Pads Red         | 79.95 Pair |
| 15721  | 62-64 | Impala/SS | Armrest Pads Saddle      | 79.95 Pair |
| 15722  | 62-64 | Impala/SS | Armrest Pads White       | 79.95 Pair |
| 15746  | 65-67 | Impala/SS | Armrest Pads Aqua        | 79.95 Pair |
| 15747  | 65-67 | Impala/SS | Armrest Pads Black       | 79.95 Pair |
| 15748  | 65-67 | Impala/SS | Armrest Pads Light Blue  | 79.95 Pair |
| 15749  | 65-67 | Impala/SS | Armrest Pads Bright Blue | 79.95 Pair |
| 15750  | 65-67 | Impala/SS | Armrest Pads Fawn        | 79.95 Pair |
| 15751  | 65-67 | Impala/SS | Armrest Pads Red         | 79.95 Pair |
| 15752  | 65-67 | Impala/SS | Armrest Pads Saddle      | 79.95 Pair |
| 15753  | 65-67 | Impala/SS | Armrest Pads White       | 79.95 Pair |
| 15754  | 65-67 | Impala/SS | Armrest Pads Off White   | 79.95 Pair |
| 15755  | 65-67 | Impala/SS | Armrest Pads Gold        | 79.95 Pair |
| 15756  | 65-67 | Impala/SS | Armrest Pads Slate       | 79.95 Pair |

## Armrests / Ash Trays / Battery Parts

### ARMREST TRIM



| Part# | Year  | Model  | Part                     | Price       |
|-------|-------|--------|--------------------------|-------------|
| 12939 | 58    | Impala | Armrest Trim Bezel LH    | 35.95 Ea.   |
| 12940 | 58    | Impala | Armrest Trim Bezel RH    | 35.95 Ea.   |
| 12941 | 58    | Impala | Front Armrest End Cap LH | 20.95 Ea.   |
| 12942 | 58    | Impala | Front Armrest End Cap RH | 20.95 Ea.   |
| 15189 | 59-61 | Impala | Front Armrest End Caps   | 50.95 Pair  |
| 15537 | 59-61 | Impala | Armrest Reflectors       | 109.95 Pair |
| 10059 | 68-70 | Impala | Armrest Trim             | 38.95 Pair  |

### ASH TRAYS & PARTS

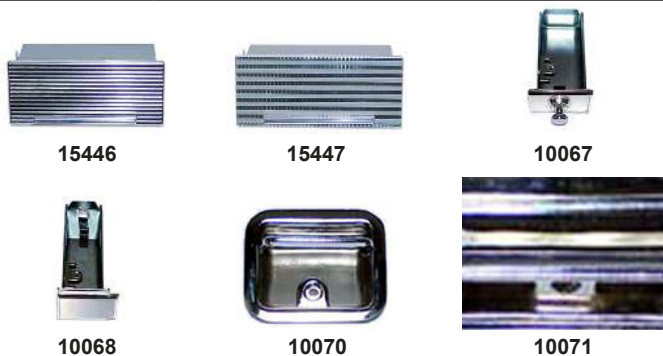

| Part# | Year  | Model               | Part                           | Price     |
|-------|-------|---------------------|--------------------------------|-----------|
| 15446 | 61    | Impala              | Ash Tray                       | 99.95 Ea. |
| 15447 | 62    | Impala              | Ash Tray                       | 99.95 Ea. |
| 10067 | 64    | Impala              | Ash Tray Assembly              | 49.95 Ea. |
| 10068 | 65-66 | Impala              | Ash Tray Assembly LH           | 49.95 Ea. |
| 10069 | 65-66 | Impala              | Ash Tray Assembly RH           | 49.95 Ea. |
| 10070 | 62-64 | Impala 4-Dr         | Rear Ash Tray Assembly         | 25.95 Ea. |
| 10066 | 60-67 | Impala Hardtop      | Rear Quarter Ash Tray Assembly | 25.95 Ea. |
| 10071 | 68-75 | Hardtop/Convertible | Rear Quarter Ash Tray Assembly | 45.95 Ea. |
| 15772 | 61-62 | All                 | Dash Ash Tray Slider Bracket   | 39.95 Ea. |

### BATTERY MAT



This mat traps and neutralizes acid and resists corrosion of battery boxes and surrounding areas. Designed as a 1 size fits all, cut to fit. Made of 100% USA origin components and recyclable materials.

| Part# | Year  | Model | Part        | Price    |
|-------|-------|-------|-------------|----------|
| 3722  | 58-70 | All   | Battery Mat | 5.95 Ea. |

### NEGATIVE BATTERY CABLE RETAINER



| Part# | Year  | Model                          | Part   | Price     |
|-------|-------|--------------------------------|--|-----------|
| 16279 | 67-72 | Small Block w/ Long Water Pump | Alternator Bracket Negative Battery Cable Retainer | 12.95 Ea. |

### BATTERY HOLDDOWNS & RETAINERS

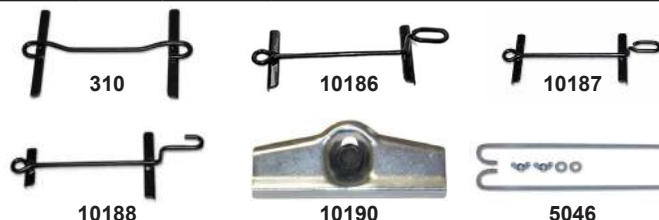

| Part# | Year  | Model | Part                               | Price     |
|-------|-------|-------|------------------------------------|-----------|
| 310   | 58    | All   | Battery Holddown                   | 9.95 Ea.  |
| 10186 | 59    | All   | Battery Retainer                   | 12.95 Ea. |
| 10187 | 60    | All   | Battery Retainer                   | 9.95 Ea.  |
| 10186 | 61    | All   | Battery Retainer                   | 12.95 Ea. |
| 10188 | 62-63 | All   | Battery Retainer                   | 9.95 Ea.  |
| 10189 | 64    | All   | Battery Retainer                   | 9.95 Ea.  |
| 10190 | 66-75 | All   | Battery Retainer                   | 3.95 Ea.  |
| 5046  | 58-65 | All   | Battery Holddown Bolts (Universal) | 6.95 Set  |

### BATTERY TRAYS



| Part# | Year  | Model | Part                       | Price     |
|-------|-------|-------|----------------------------|-----------|
| 10178 | 58    | All   | Battery Tray               | 35.95 Ea. |
| 10179 | 59-61 | All   | Battery Tray               | 29.95 Ea. |
| 10180 | 62-63 | All   | Battery Tray               | 25.95 Ea. |
| 10181 | 64    | All   | Battery Tray               | 19.95 Ea. |
| 10182 | 65    | All   | Battery Tray               | 25.95 Ea. |
| 10183 | 66    | All   | Battery Tray               | 20.95 Ea. |
| 10184 | 67    | All   | Battery Tray               | 21.95 Ea. |
| 10185 | 68    | All   | Battery Tray               | 22.95 Ea. |
| 16323 | 69    | All   | Battery Tray               | 19.95 Ea. |
| 8092  | 61-70 | All   | Oil Pan Battery Cable Clip | 7.95 Ea.  |

## Body Mounts / Brakes

### BODY MOUNTS & SHIMS



10191



10194



10195



10199



10201



10198

| Part# | Year  | Model         | Part                     | Price      |
|-------|-------|---------------|--------------------------|------------|
| 10191 | 58    | Hardtop/Sedan | Body Mount Kit           | 64.95 Kit  |
| 10192 | 58-60 | Convertible   | Body Mount Kit           | 48.95 Kit  |
| 10193 | 59    | Hardtop/Sedan | Body Mount Kit           | 129.95 Kit |
| 10194 | 60-64 | Hardtop/Sedan | Body Mount Kit           | 35.95 Kit  |
| 10195 | 61-64 | Convertible   | Body Mount Kit           | 55.95 Kit  |
| 10196 | 65-66 | Hardtop/Sedan | Body Mount Kit           | 69.95 Kit  |
| 10197 | 65-66 | Convertible   | Body Mount Kit           | 69.95 Kit  |
| 15341 | 65-70 | Hardtop/Sedan | Urethane Body Mount Kit  | 169.95 Kit |
| 10198 | 67-68 | Hardtop/Sedan | Body Mount Kit           | 69.95 Kit  |
| 10199 | 67-68 | Convertible   | Body Mount Kit           | 95.95 Kit  |
| 10200 | 69-70 | Hardtop/Sedan | Body Mount Kit           | 69.95 Kit  |
| 10201 | 69-70 | Convertible   | Body Mount Kit           | 69.95 Kit  |
| 1919  | 58-63 | All           | Body Mount Shims (10 Pc) | 15.95 Pkg  |

### BODY MOUNT BOLT KITS



10203



10204



10206

| Part# | Year  | Model         | Part                | Price     |
|-------|-------|---------------|---------------------|-----------|
| 10202 | 60-64 | Hardtop/Sedan | Body Mount Bolt Kit | 28.95 Kit |
| 10203 | 61-64 | Convertible   | Body Mount Bolt Kit | 45.95 Kit |
| 10204 | 65-66 | Hardtop/Sedan | Body Mount Bolt Kit | 22.95 Kit |
| 10205 | 65-66 | Convertible   | Body Mount Bolt Kit | 22.95 Kit |
| 10206 | 67-68 | Hardtop       | Body Mount Bolt Kit | 22.95 Kit |
| 10207 | 69-70 | Hardtop       | Body Mount Bolt Kit | 22.95 Kit |

### STOP LIGHT SWITCHES



10274



10275

| Part# | Year  | Model      | Part              | Price     |
|-------|-------|------------|-------------------|-----------|
| 10274 | 58-66 | All        | Stop Light Switch | 7.95 Ea.  |
| 10275 | 67-70 | w/Cruise   | Stop Light Switch | 19.95 Ea. |
| 10274 | 67-70 | w/O Cruise | Stop Light Swtich | 7.95 Ea.  |

### BRAKE SHOES



10273



472

| Part# | Year  | Model | Part              | Price     |
|-------|-------|-------|-------------------|-----------|
| 473   | 58    | All   | Front Brake Shoes | 59.95 Set |
| 10273 | 59-70 | All   | Front Brake Shoes | 29.95 Set |
| 472   | 58    | All   | Rear Brake Shoes  | 45.95 Set |
| 473   | 59-70 | All   | Rear Brake Shoes  | 59.95 Set |

### BRAKE PEDAL PADS & TRIM



10265



10267



10266



10268



10269



10270



10271



10272

| Part# | Year  | Model                      | Part                   | Price     |
|-------|-------|----------------------------|------------------------|-----------|
| 10265 | 58-64 | Automatic w/o Power Brakes | Brake Pedal Pad        | 8.95 Ea.  |
| 10267 | 58-64 | Automatic w/ Power Brakes  | Brake Pedal Pad        | 8.95 Ea.  |
| 10266 | 58-64 | Standard w/o Power Brakes  | Brake/Clutch Pedal Pad | 7.95 Ea.  |
| 10268 | 58-64 | Standard w/ Power Brakes   | Brake Pedal Pad        | 7.95 Ea.  |
| 10269 | 65-70 | Automatic w/Disc           | Brake Pedal Pad        | 11.95 Ea. |
| 15545 | 65-70 | Automatic w/o Disc         | Brake Pedal Pad        | 8.95 Ea.  |
| 10270 | 65-70 | Automatic                  | Brake Pedal Pad Trim   | 8.95 Ea.  |
| 10271 | 65-70 | Standard                   | Brake Pedal Pad        | 8.95 Ea.  |
| 10272 | 65-70 | Standard                   | Brake Pedal Pad Trim   | 8.95 Ea.  |

# Brakes

## BRAKE HARDWARE KITS

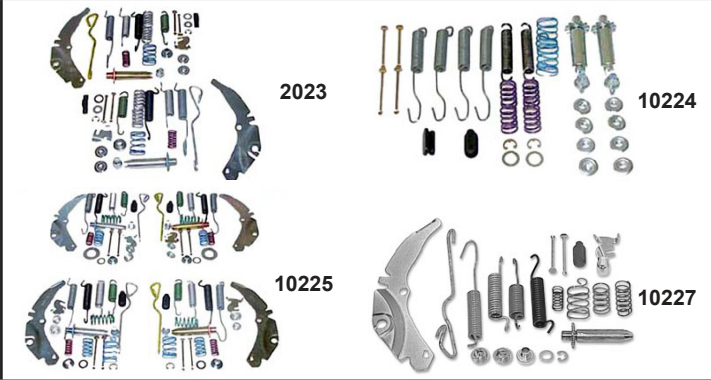

NOTE: Parts 2023, 10225, 10226, 10227 are used to convert brakes to self-adjusting type.

| Part # | Year  | Model | Part                       | Price     |
|--------|-------|-------|----------------------------|-----------|
| 469    | 58    | All   | Brake Hardware Kit         | 59.95 Kit |
| 2021   | 58    | All   | Front Brake Hardware Kit   | 30.95 Kit |
| 2022   | 58    | All   | Rear Brake Hardware Kit    | 30.95 Kit |
| 2023   | 58    | All   | Rear Brake Hardware Kit    | 50.95 Kit |
| 10223  | 59-62 | All   | Front Brake Hardware Kit   | 30.95 Kit |
| 10224  | 59-62 | All   | Rear Brake Hardware Kit    | 29.95 Kit |
| 10225  | 63-70 | All   | Brake Hardware Kit         | 85.95 Kit |
| 10226  | 63-70 | All   | Front Brake Hardware Kit   | 49.95 Kit |
| 10227  | 63-70 | All   | Rear Brake Hardware Kit    | 49.95 Kit |
| 4053   | 58-64 | All   | Parking Brake Spreader Bar | 9.95 Ea.  |
| 4054   | 58-64 | All   | Brake Guide Plate          | 6.95 Ea.  |

## BRAKE HOSES



| Part # | Year  | Model | Part                     | Price     |
|--------|-------|-------|--------------------------|-----------|
| 10228  | 58-67 | All   | Front Brake Hose         | 12.95 Ea. |
| 10228  | 68    | All   | Front Brake Hose 14"     | 12.95 Ea. |
| 10229  | 68    | All   | Front Brake Hose 14 1/2" | 12.95 Ea. |
| 10230  | 58-62 | All   | Rear Brake Hose          | 14.95 Ea. |
| 10230  | 63    | All   | Rear Brake Hose 15 1/4"  | 14.95 Ea. |
| 10231  | 63    | All   | Rear Brake Hose 14 3/8"  | 14.95 Ea. |
| 10231  | 64    | All   | Rear Brake Hose          | 14.95 Ea. |
| 10232  | 65    | All   | Rear Brake Hose          | 14.95 Ea. |
| 10233  | 66    | All   | Rear Brake Hose          | 21.95 Ea. |
| 10234  | 67-68 | All   | Rear Brake Hose          | 17.95 Ea. |
| 10235  | 69-70 | All   | Rear Brake Hose          | 22.95 Ea. |
| 1253   | 58-64 | All   | Brake Hose Clip Set      | 6.50 Set  |

## DISC BRAKE BRACKETS / ROTORS / CALIPERS

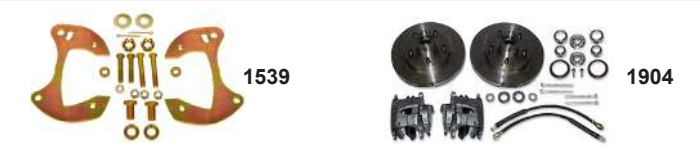

| Part # | Year  | Model | Part   | Price      |
|--------|-------|-------|--|------------|
| 1539   | 58    | All   | Disc Brake Brackets                                      | 129.95 Kit |
| 10263  | 59-64 | All   | Disc Brake Brackets                                      | 139.95 Kit |
| 13365  | 65-68 | All   | Disc Brake Brackets                                      | 149.95 Kit |
| 1904   | 58-68 | All   | Rotor & Caliper Kit (For Use w/ #1539, #10263, & #13365) | 319.95 Kit |

## STOCK SPINDLES



Replace those worn out stock spindles with these great replacements!

| Part # | Year  | Model | Part           | Price       |
|--------|-------|-------|----------------|-------------|
| 16225  | 59-64 | All   | Stock Spindles | 179.95 Pair |
| 16226  | 65-68 | All   | Stock Spindles | 179.95 Pair |

## DROP SPINDLES / ROTORS / CALIPERS



| Part # | Year  | Model | Part   | Price      |
|--------|-------|-------|--|------------|
| 12796  | 58-64 | All   | 2" Drop Spindles                                 | 249.95 Set |
| 15451  | 65-70 | All   | 2" Drop Spindles                                 | 269.95 Set |
| 1905   | 58-70 | All   | Rotor & Caliper Kit (For Use w/ #12796 & #15451) | 319.95 Kit |

## BRAKE JUNCTION BLOCKS



| Part # | Year  | Model | Part                       | Price     |
|--------|-------|-------|----------------------------|-----------|
| 15809  | 58-64 | All   | Front Junction Block LH    | 15.95 Ea. |
| 15810  | 58-64 | All   | Front Junction Block RH    | 15.95 Ea. |
| 1404   | 58    | All   | Junction Block At Rear End | 16.95 Ea. |
| 15811  | 59-64 | All   | Junction Block On Rear End | 15.95 Ea. |

## BOOSTER CHECK VALVES



| Part # | Year  | Model | Part                         | Price    |
|--------|-------|-------|------------------------------|----------|
| 6707   | 65-70 | All   | Booster Check Valve          | 6.95 Ea. |
| 7944   | 65-70 | All   | Booster Check Valve (Chrome) | 7.95 Ea. |

# Brakes

## BRAKE WHEEL CYLINDERS



| Part # | Year  | Model | Part                         | Price     |
|--------|-------|-------|------------------------------|-----------|
| 474    | 59    | All   | Front Wheel Cylinder LH      | 25.95 Ea. |
| 475    | 59    | All   | Front Wheel Cylinder RH      | 25.95 Ea. |
| 10276  | 60-64 | All   | Front Wheel Cylinder LH      | 25.95 Ea. |
| 10277  | 60-64 | All   | Front Wheel Cylinder RH      | 25.95 Ea. |
| 10278  | 65-70 | All   | Front Wheel Cylinder LH      | 35.95 Ea. |
| 10279  | 65-70 | All   | Front Wheel Cylinder RH      | 35.95 Ea. |
| 476    | 58-64 | All   | Rear Wheel Cylinder LH       | 25.95 Ea. |
| 477    | 58-64 | All   | Rear Wheel Cylinder RH       | 25.95 Ea. |
| 10280  | 65-70 | All   | Rear Wheel Cylinder LH Or RH | 14.95 Ea. |

## HYDRAULIC BRAKE ASSIST SYSTEMS



A high-quality direct bolt-in hydraulic brake assist system designed to upgrade manual or vacuum-assisted brakes with a powerful and compact modern hydraulic assist unit. These systems include everything you need to install into your vehicle.

| Part # | Year  | Model | Part                              | Price      |
|--------|-------|-------|-----------------------------------|------------|
| 4378★  | 58-64 | All   | Hydro-Stop Booster (Show Stopper) | 999.95 Kit |
| 4379★  | 58-64 | All   | Hydro-Stop Booster (Street Beast) | 799.95 Kit |
| 16224★ | 65-70 | All   | Hydro-Stop Booster (Street Beast) | 799.95 Kit |

## FACTORY BRAKE MASTER CYLINDERS



| Part # | Year  | Model  | Part                               | Price     |
|--------|-------|--------|------------------------------------|-----------|
| 481    | 58    | Manual | Master Cylinder                    | 89.95 Ea. |
| 10258  | 59-61 | Manual | Master Cylinder                    | 89.95 Ea. |
| 10259  | 62-66 | Manual | Master Cylinder w/1" Bore          | 69.95 Ea. |
| 10260  | 62-66 | Manual | Master Cylinder w/7/8" Bore        | 89.95 Ea. |
| 10261  | 67-70 | Drum   | Master Cylinder                    | 99.95 Ea. |
| 10262  | 67-70 | Disc   | Master Cylinder                    | 75.95 Ea. |
| 7875   | 58-64 | All    | Brake Pedal Rod Thru Firewall Boot | 10.95 Ea. |

## DUAL MASTER CYLINDERS



Direct bolt on dual master cylinder for disc brakes!

| Part # | Year  | Model | Part  | Price     |
|--------|-------|-------|---|-----------|
| 1902   | 58-64 | All   | Dual Master Cylinder For Manual Disc Brakes | 69.95 Ea. |

## PROPORTIONING VALVES & BRACKETS



| Part # | Year  | Model       | Part                        | Price     |
|--------|-------|-------------|-----------------------------|-----------|
| 1814   | 58-64 | Front Disc  | GM Type Proportioning Valve | 69.95 Ea. |
| 2745   | 58-64 | 4-Wh Disc   | GM Type Proportioning Valve | 69.95 Ea. |
| 1739   | 58-64 | Power Disc  | Proportioning Valve Bracket | 11.95 Ea. |
| 2271   | 58-64 | Manual Disc | Proportioning Valve         | 13.95 Ea. |

## FRONT DISC BRAKE CONVERSION (STOCK HEIGHT)



Kits come with bracket to attach spindles, rotors, calipers, bearings, seals, hoses, pads, proportioning valve, proportioning valve bracket, and power brake booster and master cylinder or dual master cylinder only for manual disc applications.

| Part # | Year  | Model       | Part           | Price      |
|--------|-------|-------------|----------------|------------|
| 12451♣ | 58    | Power Disc  | Conversion Kit | 559.95 Kit |
| 12452♣ | 58    | Manual Disc | Conversion Kit | 509.95 Kit |
| 12453♣ | 59-64 | Power Disc  | Conversion Kit | 626.95 Kit |
| 12454♣ | 59-64 | Manual Disc | Conversion Kit | 518.95 Kit |
| 13375♣ | 65-66 | Power Disc  | Conversion Kit | 669.95 Kit |
| 13376♣ | 67-68 | Power Disc  | Conversion Kit | 669.95 Kit |

★ = special order non-stocking item.  
♣ = add \$80.95 handling per item

# Brakes

## POWER BOOSTER KITS



Comes with all necessary hardware to completely install boosters.

| Part # | Year  | Model      | Part  | Price      |
|--------|-------|------------|---|------------|
| 15134  | 58-64 | Disc       | PB Booster w/Master Cylinder & Mounting Bracket | 229.95 Ea. |
| 13359  | 65-66 | Drum       | Power Booster Kit                               | 319.95 Ea. |
| 13360  | 65-66 | Front Disc | Power Booster Kit                               | 319.95 Ea. |
| 13361  | 65-66 | 4-Wh Disc  | Power Booster Kit                               | 319.95 Ea. |
| 13362  | 67-70 | Drum       | Power Booster Kit                               | 319.95 Ea. |
| 13363  | 67-70 | Front Disc | Power Booster Kit                               | 319.95 Ea. |
| 13364  | 67-70 | 4-Wh Disc  | Power Booster Kit                               | 319.95 Ea. |

## 4-WHEEL DISC BRAKE CONVERSION (DROP SPINDLES)



Kits come with drop spindles and brackets to attach to the rear end housing, rotors, calipers, bearings, seals, hoses, pads, proportioning valve, proportioning valve bracket, and power brake booster and master cylinder or dual master cylinder only for manual disc applications.

| Part # | Year  | Model       | Part           | Price       |
|--------|-------|-------------|----------------|-------------|
| 13383  | 58-64 | Power Disc  | Conversion Kit | 1462.95 Kit |
| 13384  | 58-64 | Manual Disc | Conversion Kit | 1328.95 Kit |
| 15482  | 65-66 | Power Disc  | Conversion Kit | 1510.95 Kit |
| 15483  | 67-70 | Power Disc  | Conversion Kit | 1510.95 Kit |

## REAR DISC BRAKE CONVERSION PARTS



| Part # | Year  | Model | Part                      | Price      |
|--------|-------|-------|---------------------------|------------|
| 2702   | 58-64 | All   | Rear Disc Brake Kit       | 695.95 Kit |
| 13366  | 65-70 | All   | Rear Disc Brake Kit       | 695.95 Kit |
| 13367  | 58-64 | All   | Rear Disc Brake Cable Kit | 69.95 Kit  |
| 13368  | 65-70 | All   | Rear Disc Brake Cable Kit | 129.95 Kit |
| 13369  | 58-64 | All   | Rear Disc Brake Line Kit  | 35.95 Kit  |
| 13370  | 65-70 | All   | Rear Disc Brake Line Kit  | 45.95 Kit  |

## FRONT DISC BRAKE CONVERSION (DROP SPINDLES)



Kits come with drop spindles, rotors, calipers, bearings, seals, hoses, pads, proportioning valve, proportioning valve bracket, and power brake booster and master cylinder or dual master cylinder only for manual disc applications.

| Part # | Year  | Model       | Part           | Price      |
|--------|-------|-------------|----------------|------------|
| 12455  | 58-64 | Power Disc  | Conversion Kit | 728.95 Kit |
| 12456  | 58-64 | Manual Disc | Conversion Kit | 620.95 Kit |
| 15480  | 65-66 | Power Disc  | Conversion Kit | 771.95 Kit |
| 15481  | 67-70 | Power Disc  | Conversion Kit | 771.95 Kit |

## 4-WHEEL DISC BRAKE CONVERSION (STOCK HEIGHT)



Kits come with bracket to attach to spindles and rear end housing, rotors, calipers, bearings, seals, hoses, pads, proportioning valve, proportioning valve bracket, and power brake booster and master cylinder or dual master cylinder only for manual disc applications.

| Part # | Year  | Model       | Part           | Price       |
|--------|-------|-------------|----------------|-------------|
| 13377  | 58    | Power Disc  | Conversion Kit | 1352.95 Kit |
| 13378  | 58    | Manual Disc | Conversion Kit | 1217.95 Kit |
| 13379  | 59-64 | Power Disc  | Conversion Kit | 1360.95 Kit |
| 13380  | 59-64 | Manual Disc | Conversion Kit | 1226.95 Kit |
| 13381  | 65-66 | Power Disc  | Conversion Kit | 1408.95 Kit |
| 13382  | 67-68 | Power Disc  | Conversion Kit | 1408.95 Kit |

## REAR DISC UPGRADE KITS



These kits are designed for a car that already has front disc brakes and just wants to add rear disc. Kits come with 4-wheel disc proportioning valve, mounting brackets for calipers, calipers, pads, brake cables, and hose kit.

| Part # | Year  | Model | Part                  | Price      |
|--------|-------|-------|-----------------------|------------|
| 13385  | 58-64 | All   | Rear Disc Upgrade Kit | 767.95 Kit |
| 13386  | 65-70 | All   | Rear Disc Upgrade Kit | 797.95 Kit |

① = add \$8.95 handling per item  
 ⚡ = add \$80.95 handling per item

# Brakes

## BRAKE LINES

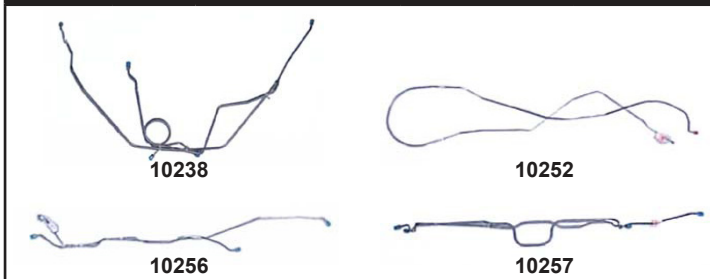

Make your brake system more safe with new lines!

| Part #  | Year  | Model            | Part            | Price     |
|---------|-------|------------------|-----------------|-----------|
| 10236 ① | 58    | Power Brakes     | Front Line      | 60.95 Set |
| 10237 ① | 58    | Manual Brakes    | Front Line      | 60.95 Set |
| 10238 ① | 59-61 | Power Brakes     | Front Line      | 60.95 Set |
| 10239 ① | 59-61 | Standard Brakes  | Front Line      | 60.95 Set |
| 10240 ① | 62-64 | Power Brakes     | Front Line      | 49.95 Set |
| 10241 ① | 62-64 | Standard Brakes  | Front Line      | 60.95 Set |
| 10242 ① | 65-66 | Power Brakes     | Front Line      | 49.95 Set |
| 10243 ① | 65-66 | Standard Brakes  | Front Line      | 49.95 Set |
| 10244 ① | 67-68 | Power Drum       | Front Line      | 65.95 Set |
| 10245 ① | 67-68 | Power Disc       | Front Line      | 65.95 Set |
| 10246 ① | 67-68 | Manual Brakes    | Front Line      | 65.95 Set |
| 10247 ① | 69    | Drum Brakes      | Front Line      | 65.95 Set |
| 10248 ① | 69    | Disc Brakes      | Front Line      | 65.95 Set |
| 10249 ② | 58-60 | All              | Long Line       | 45.95 Ea. |
| 10250 ② | 61-64 | All              | Long Line       | 45.95 Ea. |
| 10251 ② | 65    | All              | Long Line 3/16" | 55.95 Ea. |
| 10252 ② | 67-68 | All              | Long Line       | 55.95 Ea. |
| 10253 ② | 69    | All              | Long Line       | 55.95 Ea. |
| 10254 ① | 58    | All              | Rear Line       | 30.95 Set |
| 10255 ① | 59-64 | All              | Rear Line       | 30.95 Set |
| 10256 ① | 65-69 | All              | Rear Line       | 30.95 Set |
| 10257 ① | 67-69 | W/F41 Suspension | Rear Line       | 25.95 Set |

## EMERGENCY BRAKE ADJUSTMENT RODS



| Part # | Year  | Model | Part                    | Price     |
|--------|-------|-------|-------------------------|-----------|
| 1270   | 58    | All   | Adjustment Rod & Clevis | 44.95 Set |
| 10219  | 58-63 | All   | Adjustment Rod Only     | 30.95 Ea. |

## EMERGENCY BRAKE CABLE CLIPS



| Part # | Year  | Model | Part                           | Price    |
|--------|-------|-------|--------------------------------|----------|
| 1254   | 58-64 | All   | Emergency Brake Cable Clip Set | 6.95 Set |

## EMERGENCY BRAKE PADS & HANDLES

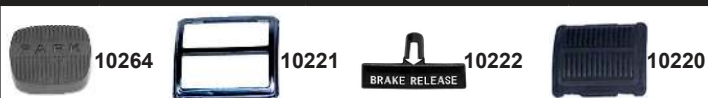

These pads and handles feature correct letters!

| Part # | Year  | Model | Part                   | Price    |
|--------|-------|-------|------------------------|----------|
| 10264  | 58-64 | All   | E-Brake Pedal Pad      | 8.95 Ea. |
| 10220  | 65-70 | All   | E-Brake Pedal Pad      | 6.95 Ea. |
| 10221  | 65-70 | All   | E-Brake Pedal Pad Trim | 6.95 Ea. |
| 15975  | 60-62 | All   | E-Brake Release Handle | 7.95 Ea. |
| 10222  | 63-70 | All   | E-Brake Release Handle | 9.95 Ea. |

## EMERGENCY BRAKE PEDAL ASSEMBLIES



| Part # | Year | Model | Part                           | Price      |
|--------|------|-------|--------------------------------|------------|
| 15148  | 63   | All   | Emergency Brake Pedal Assembly | 114.95 Ea. |
| 15149  | 64   | All   | Emergency Brake Pedal Assembly | 119.95 Ea. |
| 15150  | 65   | All   | Emergency Brake Pedal Assembly | 104.95 Ea. |

## EMERGENCY BRAKE CABLE BOOTS



| Part # | Year | Model | Part                        | Price     |
|--------|------|-------|-----------------------------|-----------|
| 1319   | 58   | All   | Emergency Brake Cable Boots | 6.95 Pair |

## BRAKE CABLES



| Part # | Year  | Model     | Part                       | Price     |
|--------|-------|-----------|----------------------------|-----------|
| 463    | 58    | All       | Front Brake Cable          | 18.95 Ea. |
| 10208  | 59-64 | All       | Front Brake Cable          | 20.95 Ea. |
| 10209  | 67-70 | w/o Turbo | Front Brake Cable          | 30.95 Ea. |
| 10210  | 67-70 | w/Turbo   | Front Brake Cable          | 20.95 Ea. |
| 10211  | 58-64 | All       | Intermediate Brake Cable   | 15.95 Ea. |
| 10212  | 65-66 | w/o Turbo | Intermediate Brake Cable   | 22.95 Ea. |
| 10213  | 65-66 | w/Turbo   | Intermediate Brake Cable   | 23.95 Ea. |
| 10214  | 67    | w/o Turbo | Intermediate Brake Cable   | 20.95 Ea. |
| 10215  | 67    | w/Turbo   | Intermediate Brake Cable   | 36.95 Ea. |
| 10214  | 68-70 | w/o 4-Spd | Intermed Brake Cable       | 19.95 Ea. |
| 10215  | 68-70 | w/4-Spd   | Intermediate Brake Cable   | 32.95 Ea. |
| 10216  | 59-64 | All       | Rear Brake Cable           | 25.95 Ea. |
| 10217  | 65-70 | All       | Rear Brake Cable           | 28.95 Ea. |
| 10218  | 63-72 | All       | Brake Cable Connector Clip | 3.50 Ea.  |

① = add \$8.95 handling per item  
② = add \$16.95 handling per item

## Bumpers (Chrome)

### BUMPERS

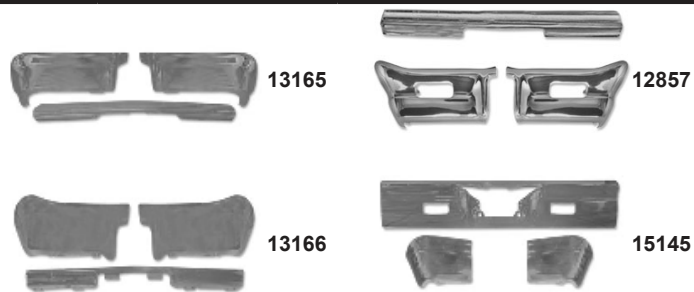

| Part#  | Year | Model     | Part              | Price      |
|--------|------|-----------|-------------------|------------|
| 15495② | 62   | All       | Front Bumper      | 399.95 Set |
| 13165② | 63   | All       | Front Bumper      | 399.95 Set |
| 12857② | 64   | All       | Front Bumper      | 399.95 Set |
| 15533② | 65   | All       | Front Bumper      | 399.95 Set |
| 13063② | 66   | All       | Front Bumper      | 399.95 Set |
| 15496② | 62   | Non-Wagon | Rear Bumper       | 399.95 Set |
| 13166② | 63   | Non-Wagon | Rear Bumper       | 399.95 Set |
| 12858② | 64   | Non-Wagon | Rear Bumper       | 399.95 Set |
| 15534② | 65   | Non-Wagon | Rear Bumper       | 399.95 Set |
| 15145② | 66   | Non-Wagon | Rear Bumper       | 409.95 Set |
| 15899③ | 62   | All       | 1-Pc Front Bumper | 359.95 Ea. |
| 15900③ | 62   | Non-Wagon | 1-Pc Rear Bumper  | 359.95 Ea. |
| 15901③ | 63   | All       | 1-Pc Front Bumper | 359.95 Ea. |
| 15902③ | 63   | Non-Wagon | 1-Pc Rear Bumper  | 359.95 Ea. |
| 15903③ | 64   | All       | 1-Pc Front Bumper | 359.95 Ea. |
| 15904③ | 64   | Non-Wagon | 1-Pc Rear Bumper  | 359.95 Ea. |

### BUMPER FILLER PANELS

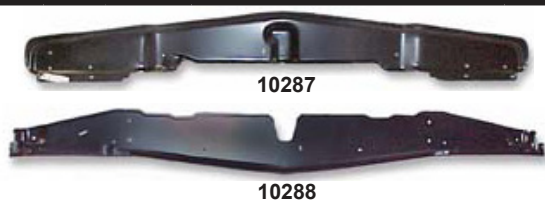

| Part#   | Year | Model | Part                              | Price      |
|---------|------|-------|-----------------------------------|------------|
| 15785②  | 62   | All   | Front Bumper Filler Panel         | 109.95 Ea. |
| 10287②  | 63   | All   | Front Bumper Filler Panel         | 99.95 Ea.  |
| 10288②  | 64   | All   | Front Bumper Filler Panel         | 119.95 Ea. |
| 16516①  | 66   | All   | Bumper Filler Panel Set           | 214.95 Set |
| 15783②★ | 66   | All   | Front Lower Bumper Panel (Black)  | 219.95 Ea. |
| 15784②★ | 66   | All   | Front Lower Bumper Panel (Chrome) | 299.95 Ea. |

### BUMPER BRACES



| Part# | Year | Model | Part                        | Price      |
|-------|------|-------|-----------------------------|------------|
| 15506 | 58   | All   | Front Inner Bumper Brace LH | 37.95 Ea.  |
| 15507 | 58   | All   | Front Inner Bumper Brace RH | 37.95 Ea.  |
| 15508 | 58   | All   | Front Outer Bumper Brace LH | 37.95 Ea.  |
| 15509 | 58   | All   | Front Outer Bumper Brace RH | 37.95 Ea.  |
| 15510 | 58   | All   | Rear Inner Bumper Brace LH  | 37.95 Ea.  |
| 15511 | 58   | All   | Rear Inner Bumper Brace RH  | 37.95 Ea.  |
| 15582 | 58   | All   | Rear Outer Bumper Brace LH  | 37.95 Ea.  |
| 13065 | 63   | All   | Front Bumper Braces         | 149.95 Set |
| 12859 | 64   | All   | Front Center Bumper Brace   | 59.95 Ea.  |
| 10291 | 64   | All   | Front Outer Bumper Brace LH | 22.95 Ea.  |
| 10292 | 64   | All   | Front Outer Bumper Brace RH | 22.95 Ea.  |
| 10293 | 64   | All   | Front Inner Bumper Brace LH | 65.95 Set  |
| 10294 | 64   | All   | Front Inner Bumper Brace RH | 65.95 Set  |
| 13184 | 66   | All   | Front Bumper Braces         | 135.95 Set |
| 13066 | 63   | All   | Rear Bumper Braces          | 139.95 Set |
| 10295 | 64   | All   | Rear Bumper Braces LH       | 65.95 Set  |
| 10296 | 64   | All   | Rear Bumper Braces RH       | 65.95 Set  |

### BUMPER GUARDS



| Part# | Year | Model     | Part                | Price       |
|-------|------|-----------|---------------------|-------------|
| 15767 | 60   | All       | Front Bumper Guards | 349.95 Pair |
| 10281 | 64   | All       | Front Bumper Guards | 149.95 Pair |
| 15766 | 65   | All       | Front Bumper Guards | 309.95 Pair |
| 13183 | 66   | All       | Front Bumper Guards | 85.95 Pair  |
| 15118 | 68   | All       | Front Bumper Guards | 179.95 Pair |
| 15768 | 60   | Non-Wagon | Rear Bumper Guards  | 85.95 Pair  |
| 10282 | 61   | All       | Rear Bumper Guards  | 49.95 Ea.   |
| 10283 | 62   | All       | Rear Bumper Guards  | 135.95 Pair |
| 10284 | 63   | All       | Rear Bumper Guards  | 155.95 Pair |
| 15996 | 64   | Non-Wagon | Rear Bumper Guards  | 189.95 Pair |
| 13053 | 65   | Non-Wagon | Rear Bumper Guards  | 159.95 Pair |
| 15119 | 68   | All       | Rear Bumper Guards  | 129.95 Pair |

★ = special order non-stocking item, please allow 4-6 weeks for delivery.  
 ① = add \$8.95 handling per item  
 ② = add \$16.95 handling per item  
 ③ = add \$80.95 handling per item

# Bumpers (Chrome) / Bumpers (Rubber)

## BUMPER TO BODY SEALS



| Part # | Year  | Model | Part                            | Price      |
|--------|-------|-------|---------------------------------|------------|
| 420    | 58    | All   | Rear Bumper To Body Seal        | 20.95 Ea.  |
| 10297  | 62    | All   | Rear Outer Bumper To Body Seals | 12.95 Set  |
| 10298  | 63    | All   | Rear Bumper To Body Seal        | 16.95 Ea.  |
| 10299  | 64    | All   | Rear Bumper To Body Seal        | 21.95 Ea.  |
| 10300  | 67    | All   | Rear Bumper To Body Seal        | 15.95 Ea.  |
| 10301  | 68    | All   | Rear Bumper To Body Seal        | 16.95 Ea.  |
| 15546  | 69-70 | All   | Rear Bumper To Body Seal        | 19.95 Ea.  |
| 10289  | 69    | All   | Front Bumper Filler Panel Seal  | 22.95 Pair |

## RUBBER & STEEL PLUGS



| Part # | Year  | Model | Part                          | Price     |
|--------|-------|-------|-------------------------------|-----------|
| 342    | 58-60 | All   | Rubber Floor Pan Plug         | 1.50 Ea.  |
| 11697  | 61-70 | All   | Steel Floor Pan Plug          | 3.50 Ea.  |
| 15683  | 59-70 | All   | Inner Rocker Panel Drain Plug | 5.00 Pair |

## BUMPER BOLT KITS



| Part # | Year | Model | Part                  | Price     |
|--------|------|-------|-----------------------|-----------|
| 12816  | 58   | All   | Front Bumper Bolt Kit | 17.95 Kit |
| 12817  | 59   | All   | Front Bumper Bolt Kit | 31.95 Kit |
| 12818  | 60   | All   | Front Bumper Bolt Kit | 17.95 Kit |
| 12819  | 61   | All   | Front Bumper Bolt Kit | 29.95 Kit |
| 12820  | 62   | All   | Front Bumper Bolt Kit | 26.95 Kit |
| 12821  | 63   | All   | Front Bumper Bolt Kit | 24.95 Kit |
| 12822  | 64   | All   | Front Bumper Bolt Kit | 26.95 Kit |
| 12823  | 60   | All   | Rear Bumper Bolt Kit  | 24.95 Kit |
| 12824  | 61   | All   | Rear Bumper Bolt Kit  | 25.95 Kit |
| 12825  | 62   | All   | Rear Bumper Bolt Kit  | 20.95 Kit |
| 12826  | 63   | All   | Rear Bumper Bolt Kit  | 24.95 Kit |
| 12827  | 64   | All   | Rear Bumper Bolt Kit  | 26.95 Kit |

## REAR LICENSE PLATE BUMPERS



| Part # | Year  | Model | Part                       | Price     |
|--------|-------|-------|----------------------------|-----------|
| 1251   | 58-59 | All   | Rear License Plate Bumpers | 2.50 Pair |
| 11671  | 60-61 | All   | Rear License Plate Bumpers | 3.00 Pair |

## GAS DOOR BUMPERS



| Part # | Year  | Model | Part             | Price     |
|--------|-------|-------|------------------|-----------|
| 11673  | 58    | All   | Gas Door Bumpers | 3.50 Pair |
| 1223   | 62-64 | All   | Gas Door Bumper  | 1.50 Ea.  |

## GLOVE BOX BUMPERS



| Part # | Year  | Model | Part                  | Price     |
|--------|-------|-------|-----------------------|-----------|
| 233    | 58-70 | All   | Glove Box Lid Bumpers | 1.50 Pair |
| 11132  | 59-60 | All   | Glove Box Arm Bumper  | 4.00 Ea.  |
| 231A   | 61-64 | All   | Glove Box Arm Bumper  | 1.50 Ea.  |

## BODY BUMPER KITS



| Part # | Year  | Model               | Part            | Price     |
|--------|-------|---------------------|-----------------|-----------|
| 11692  | 62    | Hardtop/Convertible | Body Bumper Kit | 22.95 Kit |
| 11693  | 63-64 | Hardtop/Convertible | Body Bumper Kit | 22.95 Kit |
| 11694  | 65    | Hardtop/Convertible | Body Bumper Kit | 22.95 Kit |
| 11695  | 66    | Hardtop/Convertible | Body Bumper Kit | 22.95 Kit |
| 11696  | 67-70 | Hardtop/Convertible | Body Bumper Kit | 22.95 Kit |

## DOOR BUMPERS



| Part # | Year  | Model        | Part                  | Price     |
|--------|-------|--------------|-----------------------|-----------|
| 1223   | 58    | All          | Door Bumper (1 Prong) | 1.50 Ea.  |
| 355    | 58    | All          | Door Bumper (2 Prong) | 1.00 Ea.  |
| 11674  | 59-60 | 2-Dr         | Door Bumpers          | 10.95 Set |
| 13096  | 61-64 | 2-Dr         | Door Bumpers          | 9.95 Set  |
| 13098  | 63    | 4-Dr Hardtop | Door Bumpers          | 11.95 Set |
| 13099  | 64    | 4-Dr Sedan   | Door Bumpers          | 11.95 Set |
| 13100  | 64    | 4-Dr Hardtop | Door Bumpers          | 11.95 Set |
| 11675  | 65-66 | 2-Dr         | Door Bumpers          | 6.95 Set  |
| 11676  | 67-70 | 2-Dr         | Door Bumpers          | 9.95 Set  |

# Bumpers (Rubber) / Carburetor

## VENT WINDOW BUMPERS



| Part # | Year  | Model                   | Part                    | Price      |
|--------|-------|-------------------------|-------------------------|------------|
| 11677  | 58    | Hardtop/<br>Convertible | Upper Vent Wind Bumpers | 9.95 Pair  |
| 11678  | 59-60 | Hardtop/<br>Convertible | Upper Vent Wind Bumpers | 55.95 Pair |
| 11679  | 63-64 | Hardtop                 | Upper Vent Wind Bumpers | 65.95 Pair |
| 11680  | 63-64 | Convertible             | Upper Vent Wind Bumpers | 9.95 Pair  |
| 15536  | 61-62 | Convertible             | Vent Assembly Stops     | 29.95 Pair |

## SEAT BACK STOPS



| Part # | Year  | Model     | Part            | Price     |
|--------|-------|-----------|-----------------|-----------|
| 11691  | 62-64 | Impala SS | Seat Back Stops | 19.95 Set |

## TRUNK BUMPERS



| Part # | Year  | Model | Part          | Price     |
|--------|-------|-------|---------------|-----------|
| 11689  | 58-64 | All   | Trunk Bumper  | 1.00 Ea.  |
| 11690  | 65-70 | All   | Trunk Bumpers | 4.00 Pair |

## HOOD BUMPERS



| Part # | Year  | Model | Part                            | Price     |
|--------|-------|-------|---------------------------------|-----------|
| 11681  | 58    | All   | Hood Side Bumpers               | 7.95 Pair |
| 11682  | 59-61 | All   | Hood Side Bumpers               | 6.95 Pair |
| 11683  | 62    | All   | Hood Side Bumpers               | 5.00 Set  |
| 11684  | 63-64 | All   | Hood Side Bumpers               | 5.00 Set  |
| 11685  | 65    | All   | Hood Side Bumpers               | 6.95 Set  |
| 11686  | 66-72 | All   | Hood Side Bumpers               | 5.00 Set  |
| 11687  | 59    | All   | Hood Panel To Grille<br>Bumpers | 3.00 Pair |
| 358    | 58-66 | All   | Hood Adjustment Bumpers         | 3.00 Set  |
| 11688  | 68-70 | All   | Hood Rear Bumpers               | 3.00 Pair |

## AXLE BEARINGS & BUMPERS



| Part # | Year  | Model     | Part              | Price      |
|--------|-------|-----------|-------------------|------------|
| 12701  | 58-64 | All       | Axle Bearing      | 89.95 Ea.  |
| 12702  | 65    | W/10-Bolt | Axle Bearing      | 29.95 Ea.  |
| 12702  | 66-70 | All       | Axle Bearing      | 29.95 Ea.  |
| 1845   | 58-64 | All       | Pinion Seal       | 30.95 Ea.  |
| 12703  | 65-72 | All       | Pinion Seal       | 18.95 Ea.  |
| 15941  | 58-63 | All       | Rear Axle Bumper  | 18.95 Ea.  |
| 16269  | 65-68 | All       | Rear Axle Bumpers | 99.95 Pair |

## CONTROL ARM BUMPERS



| Part # | Year  | Model | Part                     | Price    |
|--------|-------|-------|--------------------------|----------|
| 11970  | 58-70 | All   | Upper Control Arm Bumper | 4.95 Ea. |
| 13195  | 58-64 | All   | Lower Control Arm Bumper | 6.95 Ea. |

## CARBURETOR LINKAGE

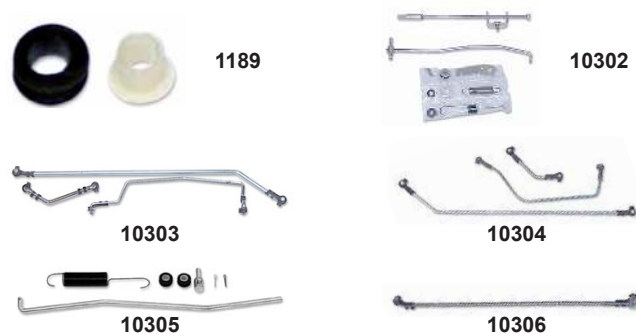

| Part # | Year  | Model          | Part                              | Price     |
|--------|-------|----------------|-----------------------------------|-----------|
| 1189   | 62-69 | All            | Carb Linkage Grommet &<br>Bushing | 6.95 Ea   |
| 10302  | 62-64 | 409            | Carb Accelerator Linkage          | 85.95 Kit |
| 10303  | 58    | 348 3X2-Barrel | Linkage Rod Kit                   | 39.95 Kit |
| 10304  | 59-61 | 348 3X2-Barrel | Linkage Rod Kit                   | 39.95 Kit |
| 10305  | 62-64 | V8 4-Barrel    | Linkage Rod Kit                   | 35.95 Kit |
| 10306  | 62-64 | 327 4-Barrel   | Passing Gear Linkage Kit          | 23.95 Kit |

# Choke / Cigarette Lighters / Clip Sets

## CHOKE TUBES



| Part # | Year  | Model                       | Part                      | Price     |
|--------|-------|-----------------------------|---------------------------|-----------|
| 2087   | 58    | 6-Cylinder                  | Choke Tube                | 5.00 Ea.  |
| 10308  | 58-61 | 348 4-Barrel                | Choke Tube                | 5.00 Ea.  |
| 10309  | 59-61 | 348 3X2-Barrel              | Choke Tube                | 5.00 Ea.  |
| 10310  | 59-65 | 283/327 4-Barrel            | Choke Tube (Carter)       | 5.00 Ea.  |
| 10311  | 62    | 409 2X4-Barrel              | Choke Tube                | 5.00 Ea.  |
| 10317  | 61-64 | 327                         | Lower Choke Tube          | 12.95 Ea. |
| 10318  | 62    | 348/409                     | Lower Choke Tube          | 12.95 Ea. |
| 10312  | 63    | 409 340Hp                   | Lower Choke Tube Chrome   | 39.95 Ea. |
| 10313  | 64    | 409 340Hp                   | Lower Choke Tube Chrome   | 39.95 Ea. |
| 10314  | 63-64 | 409 425 Hp                  | Lower Choke Tube Chrome   | 39.95 Ea. |
| 10315  | 58-64 | All                         | Choke Tube Insulation 15" | 8.95 Ea.  |
| 10316  | 58-64 | All                         | Choke Tube Insuln 9 3/4"  | 6.95 Ea.  |
| 15652  | 67-68 | Small Block 4-BBL Quadrajet | Choke Thermostat Kit      | 35.95 Kit |

## CIGARETTE LIGHTERS



| Part # | Year  | Model  | Part              | Price     |
|--------|-------|--------|-------------------|-----------|
| 15459  | 58-60 | Impala | Cigarette Lighter | 33.95 Ea. |
| 13210  | 61-63 | Impala | Cigarette Lighter | 19.95 Ea. |
| 10319  | 64    | Impala | Cigarette Lighter | 19.95 Ea. |
| 10320  | 65-66 | Impala | Cigarette Lighter | 34.95 Ea. |
| 15460  | 67    | Impala | Cigarette Lighter | 24.95 Ea. |
| 15461  | 70    | Impala | Cigarette Lighter | 37.95 Ea. |

## DOOR PANEL RETAINER PLUGS



| Part # | Year  | Model | Part  | Price    |
|--------|-------|-------|---|----------|
| 16274  | 61-66 | All   | Door Panel Retainer Plugs (Does Both Doors) | 7.95 Set |

## WINDSHIELD MOLDING CLIP SETS



| Part # | Year  | Model                   | Part                              | Price     |
|--------|-------|-------------------------|-----------------------------------|-----------|
| 12973  | 58    | Impala                  | Windshield Molding Clips          | 19.95 Set |
| 16051  | 59-60 | Impala Sedan/ El Camino | Windshield Lower Molding Clips    | 32.95 Set |
| 16052  | 59-60 | Impala Sedan/ El Camino | Windshield Upper Molding Clips    | 15.95 Set |
| 11365  | 61-64 | 2-Dr Hardtop            | Windshield Upper Moldng Clips     | 10.95 Set |
| 11366  | 65-66 | 2-Dr Hardtop            | Windshield Upper Molding Clips    | 9.95 Set  |
| 13102  | 67    | 2-Dr Hardtop            | Windshield Molding Clips          | 10.95 Set |
| 15828  | 63-64 | Impala                  | Complete Windshield Molding Clips | 35.95 Set |
| 15830  | 65-67 | Impala                  | Complete Windshield Molding Clips | 35.95 Set |
| 11367  | 62-64 | 2-Dr Hardtop            | Back Glass Upper Molding Clips    | 10.95 Set |
| 11368  | 65-66 | 2-Dr Hardtop            | Back Glass Molding Clips          | 12.95 Set |
| 13103  | 67    | 2-Dr Hardtop            | Back Glass Molding Clips          | 13.95 Set |
| 15829  | 62-64 | Impala                  | Complete Back Glass Molding Clips | 33.95 Set |

## COMPLETE MOLDING CLIP SETS

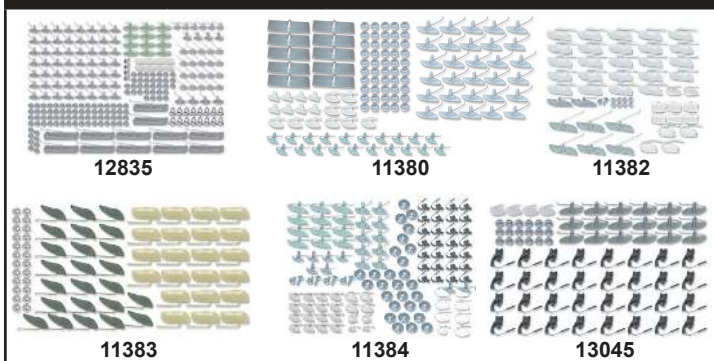

| Part # | Year | Model       | Part               | Price     |
|--------|------|-------------|--------------------|-----------|
| 12835  | 58   | Impala 2-Dr | Side Molding Clips | 85.95 Set |
| 12836  | 59   | Impala 2-Dr | Side Molding Clips | 85.95 Set |
| 11380  | 61   | Impala 2-Dr | Side Molding Clips | 49.95 Set |
| 11381  | 62   | Impala 2-Dr | Side Molding Clips | 70.95 Set |
| 11382  | 63   | Impala 2-Dr | Side Molding Clips | 29.95 Set |
| 11383  | 64   | Impala SS   | Side Molding Clips | 60.95 Set |
| 11384  | 64   | Impala 2-Dr | Side Molding Clips | 49.95 Set |
| 11385  | 64   | Impala 4-Dr | Side Molding Clips | 75.95 Set |
| 12837  | 66   | Impala 2-Dr | Side Molding Clips | 34.95 Set |
| 13045  | 68   | Impala 2-Dr | Side Molding Clips | 40.95 Set |

# Clip Sets / Clocks / Clutch

## MOLDING CLIP SETS



| Part # | Year | Model           | Part                           | Price     |
|--------|------|-----------------|--------------------------------|-----------|
| 11370  | 58   | Impala          | Pitch Fork Molding Clip Set    | 10.95 Set |
| 11371  | 58   | Impala          | Quarter Panel Molding Clip Set | 55.95 Set |
| 12972  | 58   | Delray/Biscayne | Side Molding Clip              | 2.00 Ea.  |
| 15677  | 59   | Impala 2-Dr     | Fender Molding Clip Set        | 35.95 Set |
| 15678  | 59   | Impala 2-Dr     | Door Molding Clip Set          | 54.95 Set |
| 15679  | 59   | Impala 2-Dr     | Quarter Molding Clip Set       | 59.95 Set |
| 13397  | 59   | El Camino       | Fender Molding First Clip      | 6.95 Ea.  |
| 13395  | 59   | El Camino       | Body Side Molding Clip         | 2.50 Ea.  |
| 13396  | 59   | El Camino       | Tailgate Fin Molding Clip      | 2.50 Ea.  |

## CLOCK PARTS

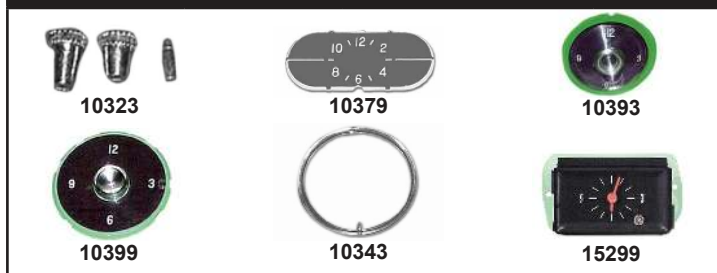

| Part # | Year  | Model                   | Part            | Price      |
|--------|-------|-------------------------|-----------------|------------|
| 10323  | 61-81 | All                     | Clock Knob Kit  | 15.95 Kit  |
| 10379  | 58    | All                     | Clock Face Lens | 42.95 Ea.  |
| 10392  | 59-60 | Westclox                | Clock Face Lens | 42.95 Ea.  |
| 10393  | 59-60 | Borg Warner             | Clock Face Lens | 45.95 Ea.  |
| 15974  | 61-62 | Impala/Bel-Air/Biscayne | Dash Clock      | 239.95 Ea. |
| 10399  | 61-62 | Westclox                | Clock Face Lens | 42.95 Ea.  |
| 10400  | 61-62 | Borg Warner             | Clock Face Lens | 42.95 Ea.  |
| 10343  | 64-67 | All Face Lens           | Console Clock   | 18.95 Ea.  |
| 15299  | 64    | All                     | Clock           | 179.95 Ea. |
| 15693  | 65    | Impala SS               | Console Clock   | 149.95 Ea. |
| 16129  | 65    | All                     | Clock Lens      | 45.95 Ea.  |

|       |       |             |  |           |
|-------|-------|-------------|--|-----------|
| 11372 | 59    | All         | Trunk Molding Clip Set   | 11.95 Set |
| 16275 | 60    | Impala      | Trunk Molding Clip   | 5.00 Ea.  |
| 15253 | 59    | All         | Rear Fin Molding Clip Set<br><b>Does One Side Only (2 Sets Will Be Needed Per Car)</b> | 29.95 Set |
| 13401 | 60    | El Camino   | Tailgate Fin Molding Clips   | 39.95 Set |
| 13399 | 59-60 | El Camino   | Bed Molding Clip Set   | 46.95 Set |
| 11373 | 59-61 | All         | Rocker Molding Clip Set  | 29.95 Set |
| 11374 | 62    | All         | Rocker Molding Clip Set  | 20.95 Set |
| 15168 | 62    | Impala & SS | Trunk Lid Trim Panel Clips   | 18.95 Set |
| 11375 | 63    | All         | Rear Cover Molding Clip Set  | 14.95 Set |
| 12829 | 64    | All         | Eyebrow Molding Clip Set   | 12.95 Set |
| 13104 | 64    | Impala SS   | Fender Molding Clip Set  | 14.95 Set |
| 11378 | 64    | Impala      | Quarter Panel Molding Clip Set   | 27.95 Set |
| 11379 | 64    | Impala      | Quarter Panel "C" Molding Clip Set   | 15.95 Set |
| 13106 | 66    | Impala 2-Dr | Door Molding Clip Set  | 19.95 Set |
| 13107 | 66    | Impala 2-Dr | Quarter Molding Clip Set   | 29.95 Set |
| 15897 | 60    | Impala 2-Dr | Quarter Molding Clip Set (1-Side)  | 17.95 Set |
| 12830 | 64    | All         | Headlight Bezel Retaining Clip   | 1.00 Ea.  |
| 12831 | 65    | All         | Headlight Bezel Retaining Clip   | 1.00 Ea.  |
| 12832 | 66-67 | All         | Headlight Bezel Retaining Clip   | 1.00 Ea.  |
| 12833 | 61-64 | All         | License Plate Panel Clip   | 1.00 Ea.  |
| 12834 | 62    | Impala      | Taillight Bezel Clip Set   | 4.00 Set  |
| 12838 | 64    | Impala SS   | Trunk Molding Cli P Set  | 17.95 Set |

## CLUTCH BOOTS



| Part # | Year  | Model       | Part                     | Price     |
|--------|-------|-------------|--------------------------|-----------|
| 376    | 58-60 | All         | Clutch Fork Boot         | 23.95 Ea. |
| 10324  | 61-62 | All         | Clutch Fork Boot         | 45.95 Ea. |
| 10325  | 63    | All w/o 409 | Clutch Fork Boot         | 10.95 Ea. |
| 10324  | 63    | w/409       | Clutch Fork Boot         | 45.95 Ea. |
| 10325  | 64-75 | All         | Clutch Fork Boot         | 10.95 Ea. |
| 13115  | 65-68 | All         | Clutch Rod Firewall Boot | 10.95 Ea. |

# Clutch / Console

## CLUTCH Z-BARS



| Part # | Year  | Model       | Part                            | Price     |
|--------|-------|-------------|---------------------------------|-----------|
| 12809  | 59    | Small Block | Clutch Z-Bar                    | 39.95 Ea. |
| 12810  | 62-64 | All w/o 409 | Clutch Z-Bar                    | 27.95 Ea. |
| 12811  | 65-70 | All         | Clutch Z-Bar                    | 29.95 Ea. |
| 10328  | 58-70 | All         | Clutch Z-Bar Stud Retainer Clip | 3.00 Ea.  |

## CLUTCH PARTS



| Part # | Year  | Model          | Part                                | Price     |
|--------|-------|----------------|-------------------------------------|-----------|
| 10326  | 58-70 | All            | Clutch Rod Nut (2 Per Car)          | 1.50 Ea.  |
| 10327  | 58-70 | All            | Clutch Rod Seat (2 Per Car)         | 3.50 Ea.  |
| 15328  | 58-70 | All            | Block Side Screw In Pivot Ball      | 10.95 Ea. |
| 1335   | 58-70 | All            | Clutch Pedal Bushings               | 5.00 Set  |
| 15656  | 69-70 | Small Block    | Clutch Return Spring Extension Wire | 6.95 Ea.  |
| 16036  | 58    | V8 Small Block | Clutch Cross Shaft                  | 37.95 Ea. |

## CLUTCH FORK



| Part # | Year  | Model       | Part        | Price      |
|--------|-------|-------------|-------------|------------|
| 789    | 58-60 | Small Block | Clutch Fork | 70.95 Ea.  |
| 10331  | 65-69 | All         | Clutch Fork | 109.95 Ea. |

## UPPER CLUTCH RODS



| Part # | Year  | Model | Part             | Price     |
|--------|-------|-------|------------------|-----------|
| 16037  | 58    | All   | Upper Clutch Rod | 42.95 Ea. |
| 16038  | 59-61 | All   | Upper Clutch Rod | 42.95 Ea. |
| 12814  | 63-64 | All   | Upper Clutch Rod | 39.95 Ea. |
| 12815  | 65-70 | All   | Upper Clutch Rod | 29.95 Ea. |

## CROSS SHAFT FRAME BRACKETS



| Part # | Year  | Model | Part                      | Price     |
|--------|-------|-------|---------------------------|-----------|
| 12812  | 60-64 | All   | Cross Shaft Frame Bracket | 19.95 Ea. |
| 12813  | 65-70 | All   | Cross Shaft Frame Bracket | 17.95 Ea. |

## CONSOLES



These correct reproduction consoles come completely assembled and ready to install.

| Part # | Year | Model                 | Part    | Price      |
|--------|------|-----------------------|---------|------------|
| 15330  | 63   | Impala SS             | Console | 629.95 Ea. |
| 15332  | 64   | Impala SS w/4-Spd     | Console | 619.95 Ea. |
| 15333  | 64   | Impala SS w/Automatic | Console | 619.95 Ea. |

## BENCH SEAT CONSOLES



| Part # | Year  | Model | Part                                   | Price      |
|--------|-------|-------|--|------------|
| 4393   | 58-70 | All   | Bench Seat Console /Black              | 135.95 Ea. |
| 4394   | 58-70 | All   | Bench Seat Console /Red                | 135.95 Ea. |
| 4395   | 58-70 | All   | Bench Seat Console / Turquoise         | 135.95 Ea. |
| 4396   | 58-70 | All   | Bench Seat Console / Bright Blue       | 135.95 Ea. |
| 4397   | 58-70 | All   | Bench Seat Console /Gray               | 135.95 Ea. |
| 4586   | 58-70 | All   | Bench Seat Console /Tan                | 135.95 Ea. |
| 4398   | 58-70 | All   | Bench Seat Shorty Console/ Black       | 125.95 Ea. |
| 4399   | 58-70 | All   | Bench Seat Shorty Console/Red          | 125.95 Ea. |
| 4400   | 58-70 | All   | Bench Seat Shorty Console/ Turquoise   | 125.95 Ea. |
| 4401   | 58-70 | All   | Bench Seat Shorty Console/ Bright Blue | 125.95 Ea. |
| 4402   | 58-70 | All   | Bench Seat Shorty Console/ Gray        | 125.95 Ea. |
| 4587   | 58-70 | All   | Bench Seat Shorty Console/Tan          | 125.95 Ea. |

## TRANSMISSION HUMP CONSOLES



| Part # | Year  | Model | Part                                   | Price      |
|--------|-------|-------|--|------------|
| 4403   | 58-70 | All   | Transmission Hump Console/Black        | 145.95 Ea. |
| 4404   | 58-70 | All   | Transmission Hump Console/Red          | 145.95 Ea. |
| 4405   | 58-70 | All   | Transmission Hump Console/ Turquoise   | 145.95 Ea. |
| 4406   | 58-70 | All   | Transmission Hump Console/ Bright Blue | 145.95 Ea. |
| 4407   | 58-70 | All   | Transmission Hump Console/Gray         | 145.95 Ea. |
| 4588   | 58-70 | All   | Transmission Hump Console/Tan          | 145.95 Ea. |

# Console / Convertible Parts

## CONSOLE SHIFT PLATES



| Part # | Year  | Model                      | Part                         | Price      |
|--------|-------|----------------------------|------------------------------|------------|
| 15331  | 63    | Impala SS w/ Automatic     | Shift Plate                  | 115.95 Ea. |
| 10338  | 63    | Impala SS w/4-Spd          | Shift Plate                  | 49.95 Ea.  |
| 16331  | 64    | w/Turbo 350/450            | Console Shift Indicator Lens | 12.95 Ea.  |
| 16332  | 64    | Impala w/200-4R/700R4/4L60 | Console Shift Indicator Lens | 12.95 Ea.  |
| 10339  | 65    | Powerglide                 | Shift Plate                  | 69.95 Ea.  |
| 10340  | 65    | Turbo                      | Shift Plate                  | 69.95 Ea.  |
| 16333  | 66-67 | Impala w/200-4R/700R4/4L60 | Console Shift Indicator Lens | 12.95 Ea.  |
| 10341  | 66-67 | Powerglide                 | Shift Plate                  | 55.95 Ea.  |
| 10342  | 66-67 | Turbo                      | Shift Plate                  | 55.95 Ea.  |
| 11057  | 64-67 | Automatic                  | Console Slider               | 6.95 Ea.   |

## CONSOLE LIGHT LENSES



| Part # | Year  | Model               | Part               | Price     |
|--------|-------|---------------------|--------------------|-----------|
| 10332  | 62    | Impala SS           | Console Light Lens | 13.95 Ea. |
| 10333  | 63    | Impala SS           | Console Light Lens | 25.95 Ea. |
| 10334  | 64    | All                 | Console Light Lens | 9.95 Ea.  |
| 10335  | 65    | Impala SS Automatic | Console Light Lens | 42.95 Ea. |
| 10336  | 65    | Impala SS 4-Spd     | Console Light Lens | 42.95 Ea. |
| 10337  | 66-99 | Impala SS/Caprice   | Console Light Lens | 55.95 Ea. |

## CONSOLE EMBLEMS



| Part # | Year  | Model     | Part                  | Price     |
|--------|-------|-----------|-----------------------|-----------|
| 10649  | 61-62 | Impala    | Console X-Flag Emblem | 45.95 Ea. |
| 10650  | 63    | Impala SS | Console Emblem        | 50.95 Ea. |
| 10651  | 64    | Impala SS | Console Emblem        | 42.95 Ea. |
| 10652  | 65    | Impala SS | Console Emblem        | 69.95 Ea. |

## CENTER CONSOLE BASE



| Part # | Year | Model     | Part                | Price      |
|--------|------|-----------|---------------------|------------|
| 15273  | 63   | Impala SS | Center Console Base | 119.95 Ea. |

## CONSOLE TRIM PARTS

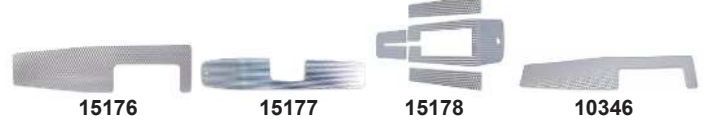

| Part # | Year | Model               | Part                 | Price      |
|--------|------|---------------------|----------------------|------------|
| 15176  | 63   | Impala SS           | Machined Trim Insert | 69.95 Ea.  |
| 15177  | 64   | Impala SS 4-Spd     | Machined Trim Insert | 79.95 Ea.  |
| 15178  | 64   | Impala SS Automatic | Machined Trim Insert | 109.95 Ea. |
| 10346  | 63   | Impala SS Automatic | Trim Tape Insert     | 19.95 Ea.  |

## CONSOLE LOCKS



| Part # | Year  | Model | Part         | Price     |
|--------|-------|-------|--------------|-----------|
| 1717   | 65-67 | All   | Console Lock | 27.95 Ea. |
| 22539  | 62-64 | All   | Console Lock | 24.95 Ea. |

## MISCELLANEOUS CONSOLE PARTS



| Part # | Year  | Model            | Part                     | Price     |
|--------|-------|------------------|--------------------------|-----------|
| 10343  | 64-67 | All              | Console Clock Lens       | 18.95 Ea. |
| 15935  | 65    | w/Console        | Console Clock Lens       | 16.95 Ea. |
| 10344  | 68-69 | All              | Console Seat Belt Pocket | 50.95 Ea. |
| 10345  | 61-63 | Impala 4-Spd     | Tunnel Extension Seal    | 19.95 Ea. |
| 10345  | 63    | Impala Automatic | Tunnel Extension Seal    | 19.95 Ea. |

## CONVERTIBLE TOP HANDLES & LATCHES



| Part # | Year  | Model       | Part                | Price       |
|--------|-------|-------------|---------------------|-------------|
| 213    | 58-60 | Convertible | Top Handles         | 89.95 Pair  |
| 15671  | 58    | Convertible | Top Striker Plates  | 99.95 Pair  |
| 12979  | 59-60 | Convertible | Top Striker Plates  | 119.95 Pair |
| 10350  | 61-64 | Convertible | Top Latch Bushings  | 22.95 Set   |
| 10351  | 58-64 | Convertible | Top Pinch Rail Pads | 22.95 Set   |
| 10349  | 61-64 | Convertible | Top Lock Latches    | 229.95 Pair |
| 15905  | 67-70 | Convertible | Top Latch LH        | 139.95 Ea.  |
| 15906  | 67-70 | Convertible | Top Latch RH        | 139.95 Ea.  |

## Convertible Parts

### CONVERTIBLE TOP HEADER BOW



A great replacement of an original header bow.

| Part#  | Year  | Model       | Part       | Price      |
|--------|-------|-------------|------------|------------|
| 16126★ | 59-60 | Convertible | Header Bow | 459.95 Ea. |

### CONVERTIBLE TOP HOLDDOWN CABLES



| Part# | Year  | Model              | Part                | Price      |
|-------|-------|--------------------|---------------------|------------|
| 15462 | 61-64 | Impala Convertible | Top Holddown Cables | 25.95 Pair |
| 15463 | 65-70 | Impala Convertible | Top Holddown Cables | 25.95 Pair |

### CONVERTIBLE TOP HOSES



| Part# | Year  | Model       | Part                        | Price      |
|-------|-------|-------------|-----------------------------|------------|
| 10358 | 58-61 | Convertible | Top Hose Kit                | 139.95 Kit |
| 10359 | 62-70 | Convertible | Top Hose<br>(2 Req Per Car) | 74.95 Ea.  |

### CONVERTIBLE TOP WEATHERSTRIPPING

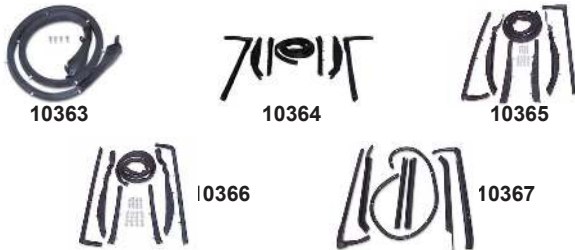

| Part# | Year  | Model       | Part                 | Price      |
|-------|-------|-------------|----------------------|------------|
| 10362 | 58-64 | Convertible | Top Header Seal Only | 16.95 Ea.  |
| 10363 | 65-70 | Convertible | Top Header Seal Only | 65.95 Ea.  |
| 10364 | 58    | Convertible | Weatherstripping Kit | 299.95 Kit |
| 10365 | 59-60 | Convertible | Weatherstripping Kit | 419.95 Kit |
| 10366 | 61-64 | Convertible | Weatherstripping Kit | 259.95 Kit |
| 10367 | 65    | Convertible | Weatherstripping Kit | 409.95 Kit |
| 10368 | 66-67 | Convertible | Weatherstripping Kit | 299.95 Set |

### CONVERTIBLE TOP PUMP MOTORS



| Part# | Year  | Model       | Part                 | Price      |
|-------|-------|-------------|----------------------|------------|
| 1353  | 58-63 | Convertible | Top Pump Motor       | 269.95 Ea. |
| 10360 | 64    | Convertible | Top Pump Motor       | 265.95 Ea. |
| 10361 | 65-70 | Convertible | Top Pump Motor       | 265.95 Ea. |
| 1312  | 58-63 | Convertible | Motor Mount Grommet  | 2.50 Ea.   |
| 12980 | 58-60 | Convertible | Top Pump Motor Cover | 79.95 Ea.  |

### CONVERTIBLE TOP CYLINDERS



These correct reproduction cylinders are made of aluminum with a slight variance in appearance from originals, but with the same fit and function.  
**NOTE: We recommend replacing both top cylinders at the same time.**

| Part# | Year  | Model       | Part         | Price      |
|-------|-------|-------------|--------------|------------|
| 10352 | 58    | Convertible | Top Cylinder | 185.95 Ea. |
| 10353 | 59-60 | Convertible | Top Cylinder | 185.95 Ea. |
| 10354 | 61    | Convertible | Top Cylinder | 165.95 Ea. |
| 10355 | 62    | Convertible | Top Cylinder | 165.95 Ea. |
| 10356 | 63-64 | Convertible | Top Cylinder | 145.95 Ea. |
| 10357 | 65-70 | Convertible | Top Cylinder | 145.95 Ea. |

### CONVERTIBLE TOP SWITCHES & KNOBS



| Part# | Year  | Model             | Part                            | Price      |
|-------|-------|-------------------|---------------------------------|------------|
| 12976 | 58-60 | Convertible       | Top Switch Knob                 | 62.95 Ea.  |
| 15818 | 58-62 | Convertible       | Top Power Switch                | 105.95 Ea. |
| 16518 | 63    | Convertible/Wagon | Power Top/Power Tailgate Switch | 75.95 Ea.  |
| 15133 | 65-68 | Convertible       | Top Power Switch                | 69.95 Ea.  |

### CONVERTIBLE TOPS

| Part#  | Year  | Model       | Part  | Price      |
|--------|-------|-------------|-------|------------|
| 15019★ | 58    | Convertible | Black | 405.95 Ea. |
| 15020★ | 58    | Convertible | White | 405.95 Ea. |
| 15021★ | 59-60 | Convertible | White | 405.95 Ea. |
| 15022★ | 59-60 | Convertible | Black | 405.95 Ea. |
| 15023★ | 61-64 | Convertible | White | 405.95 Ea. |
| 15024★ | 61-64 | Convertible | Black | 405.95 Ea. |
| 15025★ | 65-66 | Convertible | White | 499.95 Ea. |
| 15026★ | 65-66 | Convertible | Black | 499.95 Ea. |
| 15027★ | 67-70 | Convertible | White | 499.95 Ea. |
| 15028★ | 67-70 | Convertible | Black | 499.95 Ea. |

### CONVERTIBLE TOP BOOT SLIDER



| Part# | Year  | Model       | Part                              | Price      |
|-------|-------|-------------|-----------------------------------|------------|
| 15129 | 58    | Convertible | Top Boot Slider                   | 149.95 Ea. |
| 16042 | 59-60 | Convertible | Top Boot Slider                   | 179.95 Ea. |
| 15130 | 61-64 | Convertible | Top Boot Slider                   | 159.95 Ea. |
| 15675 | 58-64 | Convertible | Convertible Top Tacking Strip Kit | 64.95 Set  |

★ = special order non-stocking item.

# Convertible Parts

## CONVERTIBLE TOP WELL LINERS

Top well liners are a great addition to your top boot order. They protect the new convertible top when it is in the down position behind the rear seat. Each is made of a special water-reistant canvas backed vinyl.

| Part#  | Year  | Model       | Part      | Price     |
|--------|-------|-------------|-----------|-----------|
| 15029★ | 58    | Convertible | Black     | 72.95 Ea. |
| 15030★ | 59-60 | Convertible | Black     | 72.95 Ea. |
| 15031★ | 59-60 | Convertible | Turquoise | 82.95 Ea. |
| 15032★ | 59-60 | Convertible | Blue      | 82.95 Ea. |
| 15033★ | 59-60 | Convertible | Beige     | 82.95 Ea. |
| 15034★ | 61-64 | Convertible | Black     | 72.95 Ea. |
| 15035★ | 61-63 | Convertible | Turquoise | 82.95 Ea. |
| 15036★ | 61-63 | Convertible | Blue      | 82.95 Ea. |
| 15037★ | 61-63 | Convertible | Beige     | 82.95 Ea. |
| 15038★ | 65-66 | Convertible | Black     | 69.95 Ea. |
| 15039★ | 67-70 | Convertible | Black     | 69.95 Ea. |

## CONVERTIBLE TOP BOOT COVERS

### TOP BOOT INFORMATION

Top boots from PUI Interiors are the finest restoration top boots available in today's market. All PUI top boots are manufactured using the same vinyls used in our seat kits, and commitment to quality extends to our reinforcing materials, bindings,snaps and clips. Our top boots are assembled to match the design of its original predecessor, including all double turned bindings,rubber and/or plastic reinforcements and die cut pads.



### 1958 CONVERTIBLE

| Part#  | Year | Model       | Part      | Price      |
|--------|------|-------------|-----------|------------|
| 15040★ | 58   | Convertible | Black     | 245.95 Ea. |
| 15041★ | 58   | Convertible | Green     | 245.95 Ea. |
| 15042★ | 58   | Convertible | Blue      | 245.95 Ea. |
| 15043★ | 58   | Convertible | Turquoise | 245.95 Ea. |
| 15044★ | 58   | Convertible | Gold      | 245.95 Ea. |
| 15045★ | 58   | Convertible | Red       | 245.95 Ea. |

### 1959 CONVERTIBLE

| Part#  | Year | Model       | Part      | Price      |
|--------|------|-------------|-----------|------------|
| 15046★ | 59   | Convertible | Copper    | 219.95 Ea. |
| 15047★ | 59   | Convertible | Red       | 219.95 Ea. |
| 15048★ | 59   | Convertible | Black     | 219.95 Ea. |
| 15049★ | 59   | Convertible | Turquoise | 219.95 Ea. |
| 15050★ | 59   | Convertible | Blue      | 219.95 Ea. |
| 15051★ | 59   | Convertible | Green     | 219.95 Ea. |
| 15052★ | 59   | Convertible | Gray      | 219.95 Ea. |

### 1960 CONVERTIBLE

| Part#  | Year | Model       | Part      | Price      |
|--------|------|-------------|-----------|------------|
| 15047★ | 60   | Convertible | Red       | 219.95 Ea. |
| 15048★ | 60   | Convertible | Black     | 219.95 Ea. |
| 15049★ | 60   | Convertible | Turquoise | 219.95 Ea. |
| 15050★ | 60   | Convertible | Blue      | 219.95 Ea. |
| 15051★ | 60   | Convertible | Green     | 219.95 Ea. |
| 15053★ | 60   | Convertible | Copper    | 219.95 Ea. |

★ = special order non-stocking item.

### 1961 CONVERTIBLE

| Part#  | Year | Model       | Part      | Price      |
|--------|------|-------------|-----------|------------|
| 15054★ | 61   | Convertible | Red       | 179.95 Ea. |
| 15055★ | 61   | Convertible | Fawn      | 179.95 Ea. |
| 15056★ | 61   | Convertible | Blue      | 179.95 Ea. |
| 15057★ | 61   | Convertible | Green     | 179.95 Ea. |
| 15058★ | 61   | Convertible | Turquoise | 179.95 Ea. |
| 15059★ | 61   | Convertible | Gray      | 179.95 Ea. |

### 1962 CONVERTIBLE

| Part#  | Year | Model       | Part      | Price      |
|--------|------|-------------|-----------|------------|
| 15054★ | 62   | Convertible | Red       | 179.95 Ea. |
| 15055★ | 62   | Convertible | Fawn      | 179.95 Ea. |
| 15060★ | 62   | Convertible | Blue      | 179.95 Ea. |
| 15061★ | 62   | Convertible | Turquoise | 179.95 Ea. |
| 15062★ | 62   | Convertible | Green     | 179.95 Ea. |
| 15063★ | 62   | Convertible | Gold      | 179.95 Ea. |
| 15064★ | 62   | Convertible | Black     | 179.95 Ea. |

### 1963 CONVERTIBLE

| Part#  | Year | Model       | Part      | Price      |
|--------|------|-------------|-----------|------------|
| 15055★ | 63   | Convertible | Fawn      | 179.95 Ea. |
| 15060★ | 63   | Convertible | Blue      | 179.95 Ea. |
| 15061★ | 63   | Convertible | Turquoise | 179.95 Ea. |
| 15062★ | 63   | Convertible | Green     | 179.95 Ea. |
| 15064★ | 63   | Convertible | Black     | 179.95 Ea. |
| 15065★ | 63   | Convertible | Red       | 179.95 Ea. |
| 15066★ | 63   | Convertible | Saddle    | 179.95 Ea. |

# Convertible Parts

## CONVERTIBLE TOP BOOT COVERS, Continued

### 1964 CONVERTIBLE

| Part # | Year | Model       | Part      | Price      |
|--------|------|-------------|-----------|------------|
| 15055★ | 64   | Convertible | Fawn      | 179.95 Ea. |
| 15060★ | 64   | Convertible | Blue      | 179.95 Ea. |
| 15061★ | 64   | Convertible | Turquoise | 179.95 Ea. |
| 15064★ | 64   | Convertible | Black     | 179.95 Ea. |
| 15065★ | 64   | Convertible | Red       | 179.95 Ea. |
| 15066★ | 64   | Convertible | Saddle    | 179.95 Ea. |
| 15067★ | 64   | Convertible | Oyster    | 179.95 Ea. |
| 15068★ | 64   | Convertible | Silver    | 179.95 Ea. |
| 15069★ | 64   | Convertible | White     | 179.95 Ea. |

### 1965 IMPALA SS CONVERTIBLE

| Part # | Year | Model     | Part      | Price      |
|--------|------|-----------|-----------|------------|
| 15070★ | 65   | Impala SS | Slate     | 179.95 Ea. |
| 15071★ | 65   | Impala SS | Turquoise | 179.95 Ea. |
| 15072★ | 65   | Impala SS | Black     | 179.95 Ea. |
| 15073★ | 65   | Impala SS | Red       | 179.95 Ea. |
| 15074★ | 65   | Impala SS | White     | 179.95 Ea. |
| 15075★ | 65   | Impala SS | Blue      | 179.95 Ea. |
| 15076★ | 65   | Impala SS | Fawn      | 179.95 Ea. |
| 15077★ | 65   | Impala SS | Saddle    | 179.95 Ea. |

### 1965 IMPALA CONVERTIBLE

| Part # | Year | Model  | Part   | Price      |
|--------|------|--------|--------|------------|
| 15072★ | 65   | Impala | Black  | 179.95 Ea. |
| 15073★ | 65   | Impala | Red    | 179.95 Ea. |
| 15074★ | 65   | Impala | White  | 179.95 Ea. |
| 15075★ | 65   | Impala | Blue   | 179.95 Ea. |
| 15076★ | 65   | Impala | Fawn   | 179.95 Ea. |
| 15077★ | 65   | Impala | Saddle | 179.95 Ea. |
| 15078★ | 65   | Impala | Green  | 179.95 Ea. |

### 1966 IMPALA SS CONVERTIBLE

| Part # | Year | Model     | Part        | Price      |
|--------|------|-----------|-------------|------------|
| 15072★ | 66   | Impala SS | Black       | 179.95 Ea. |
| 15073★ | 66   | Impala SS | Red         | 179.95 Ea. |
| 15074★ | 66   | Impala SS | White       | 179.95 Ea. |
| 15075★ | 66   | Impala SS | Blue        | 179.95 Ea. |
| 15076★ | 66   | Impala SS | Fawn        | 179.95 Ea. |
| 15077★ | 66   | Impala SS | Saddle      | 179.95 Ea. |
| 15078★ | 66   | Impala SS | Green       | 179.95 Ea. |
| 15079★ | 66   | Impala SS | Bright Blue | 179.95 Ea. |
| 15080★ | 66   | Impala SS | Turquoise   | 179.95 Ea. |

### 1966 IMPALA CONVERTIBLE

| Part # | Year | Model  | Part      | Price      |
|--------|------|--------|-----------|------------|
| 15072★ | 66   | Impala | Black     | 179.95 Ea. |
| 15073★ | 66   | Impala | Red       | 179.95 Ea. |
| 15074★ | 66   | Impala | White     | 179.95 Ea. |
| 15075★ | 66   | Impala | Blue      | 179.95 Ea. |
| 15076★ | 66   | Impala | Fawn      | 179.95 Ea. |
| 15078★ | 66   | Impala | Green     | 179.95 Ea. |
| 15080★ | 66   | Impala | Turquoise | 179.95 Ea. |

### 1967 IMPALA SS CONVERTIBLE

| Part # | Year | Model     | Part        | Price      |
|--------|------|-----------|-------------|------------|
| 15072★ | 67   | Impala SS | Black       | 179.95 Ea. |
| 15073★ | 67   | Impala SS | Red         | 179.95 Ea. |
| 15079★ | 67   | Impala SS | Bright Blue | 179.95 Ea. |
| 15081★ | 67   | Impala SS | Off White   | 179.95 Ea. |
| 15082★ | 67   | Impala SS | Gold        | 179.95 Ea. |

### 1967 IMPALA CONVERTIBLE

| Part # | Year | Model  | Part        | Price      |
|--------|------|--------|-------------|------------|
| 15071★ | 67   | Impala | Turquoise   | 179.95 Ea. |
| 15072★ | 67   | Impala | Black       | 179.95 Ea. |
| 15073★ | 67   | Impala | Red         | 179.95 Ea. |
| 15075★ | 67   | Impala | Light Blue  | 179.95 Ea. |
| 15079★ | 67   | Impala | Bright Blue | 179.95 Ea. |
| 15081★ | 67   | Impala | Off White   | 179.95 Ea. |
| 15082★ | 67   | Impala | Gold        | 179.95 Ea. |

### 1968 CONVERTIBLE

| Part # | Year | Model       | Part       | Price      |
|--------|------|-------------|------------|------------|
| 15072★ | 68   | Convertible | Black      | 179.95 Ea. |
| 15073★ | 68   | Convertible | Red        | 179.95 Ea. |
| 15075★ | 68   | Convertible | Light Blue | 179.95 Ea. |
| 15083★ | 68   | Convertible | Parchment  | 179.95 Ea. |
| 15084★ | 68   | Convertible | Ivy Gold   | 179.95 Ea. |

### 1969 CONVERTIBLE

| Part # | Year | Model       | Part      | Price      |
|--------|------|-------------|-----------|------------|
| 15085★ | 69   | Convertible | Black     | 179.95 Ea. |
| 15086★ | 69   | Convertible | Parchment | 179.95 Ea. |
| 15087★ | 69   | Convertible | Red       | 179.95 Ea. |
| 15088★ | 69   | Convertible | Dark Blue | 179.95 Ea. |
| 15089★ | 69   | Convertible | Ivy Green | 179.95 Ea. |

### 1970 CONVERTIBLE

| Part # | Year | Model       | Part         | Price      |
|--------|------|-------------|--------------|------------|
| 15085★ | 70   | Convertible | Black        | 179.95 Ea. |
| 15090★ | 70   | Convertible | Dark Green   | 179.95 Ea. |
| 15091★ | 70   | Convertible | Bright Red   | 179.95 Ea. |
| 15092★ | 70   | Convertible | Light Saddle | 179.95 Ea. |

★ = special order non-stocking item.

# Convertible Parts / Continental Kit / Carboard

## CONVERTIBLE BOOT RAIL SNAPS

| Part# | Year  | Model       | Part            | Price     |
|-------|-------|-------------|-----------------|-----------|
| 15672 | 58    | Convertible | Boot Rail Snaps | 79.95 Set |
| 15673 | 59-60 | Convertible | Boot Rail Snaps | 79.95 Set |
| 15674 | 61-64 | Convertible | Boot Rail Snaps | 79.95 Set |

## HOOD TO COWL SEALS



| Part# | Year  | Model | Part                       | Price     |
|-------|-------|-------|----------------------------|-----------|
| 10369 | 58-60 | All   | Hood To Cowl Seal          | 13.95 Ea. |
| 10370 | 61-62 | All   | Hood To Cowl Seal          | 13.95 Ea. |
| 10371 | 61-62 | All   | Cowl To Cowl Panel Gaskets | 3.50 Pair |
| 10372 | 63-64 | All   | Hood To Cowl Seal          | 12.95 Ea. |
| 10373 | 65-66 | All   | Hood To Cowl Seal          | 11.95 Ea. |
| 10374 | 65-67 | All   | Cowl Ventilator Seal       | 8.95 Ea.  |

## COWL VENT GRILLE

| Part#  | Year | Model | Part             | Price      |
|--------|------|-------|------------------|------------|
| 16515① | 1962 | All   | Cowl Vent Grille | 319.95 Ea. |

## CONTINENTAL KIT SEALS



Correct reproduction seals for your continental kit!

| Part# | Year | Model | Part                         | Price     |
|-------|------|-------|------------------------------|-----------|
| 1220  | 58   | All   | Continental Kit To Body Seal | 18.95 Ea. |

## CRANKCASE VENT HOSE



This correct reproduction hose has a perfect fit for an easy install.

| Part# | Year  | Model   | Part                | Price     |
|-------|-------|---------|---------------------|-----------|
| 10375 | 68-72 | 327/350 | Crankcase Vent Hose | 17.95 Ea. |

## COAT HOOKS



These correct reproductions will give your interior a finished look.

| Part# | Year  | Model | Part       | Price      |
|-------|-------|-------|------------|------------|
| 183   | 58-66 | All   | Coat Hooks | 13.95 Pair |
| 15957 | 67-70 | All   | Coat Hooks | 15.95 Pair |

## DOOR CARDBOARD PANELS



10615



10617

These correct reproductions will give your interior a finished look.

| Part#  | Year  | Model                      | Part        | Price      |
|--------|-------|----------------------------|-------------|------------|
| 10615② | 58    | Impala Hardtop/Convertible | Door Panels | 28.95 Pair |
| 15561② | 58    | 2-Dr Sedan                 | Door Panels | 39.95 Pair |
| 15563② | 58    | 4-Dr Sedan                 | Door Panels | 85.95 Set  |
| 10616② | 59-60 | Impala 2-Dr Hardtop        | Door Panels | 29.95 Pair |
| 10617② | 62    | Impala Hardtop/Convertible | Door Panels | 29.95 Pair |
| 10618② | 63-64 | Impala Hardtop/Convertible | Door Panels | 29.95 Pair |
| 15571② | 65-66 | Impala Hardtop/Convertible | Door Panels | 45.95 Pair |
| 15574② | 69-70 | Impala Hardtop/Convertible | Door Panels | 45.95 Pair |

## QUARTER PANEL BOARDS



10620



10621

These correct reproductions will give your interior a finished look.

| Part#  | Year  | Model               | Part                 | Price      |
|--------|-------|---------------------|----------------------|------------|
| 15562① | 58    | 2-Dr Sedan          | Quarter Panel Boards | 39.95 Pair |
| 15564① | 58    | 2-Dr Impala Hardtop | Quarter Panel Boards | 30.95 Pair |
| 15565① | 58    | 2-Dr Belair Hardtop | Quarter Panel Boards | 35.95 Pair |
| 15566① | 59-60 | 2-Dr Impala Hardtop | Quarter Panel Boards | 29.95 Pair |
| 15567① | 59-60 | Impala Convertible  | Quarter Panel Boards | 20.95 Pair |
| 15568① | 61    | 2-Dr Impala Hardtop | Quarter Panel Boards | 27.95 Pair |
| 15570① | 61-64 | Impala Convertible  | Quarter Panel Boards | 22.95 Pair |
| 15569① | 62-64 | 2-Dr Impala Hardtop | Quarter Panel Boards | 23.95 Pair |
| 15572① | 65-66 | 2-Dr Impala Hardtop | Quarter Panel Boards | 28.95 Pair |
| 15573① | 65-66 | Impala Convertible  | Quarter Panel Boards | 26.95 Pair |
| 10620① | 65-66 | Impala 2-Dr Hardtop | Rear Quarter Panels  | 28.95 Pair |
| 10621① | 65-66 | Impala Convertible  | Rear Quarter Panels  | 27.95 Pair |
| 15575① | 69-70 | Impala Convertible  | Quarter Panel Boards | 23.95 Pair |

① = add \$8.95 handling per item  
② = add \$16.95 handling per item

# Dash Parts

## WATERSHIELD SETS



12033



12037

| Part # | Year  | Model        | Part            | Price     |
|--------|-------|--------------|-----------------|-----------|
| 12033  | 59-60 | 2-Dr Hardtop | Watershield Set | 15.95 Set |
| 12034  | 61-62 | 2-Dr Hardtop | Watershield Set | 15.95 Set |
| 12035  | 63-64 | 2-Dr Hardtop | Watershield Set | 15.95 Set |
| 12036  | 63-64 | 4-Dr Sedan   | Watershield Set | 16.95 Set |
| 12037  | 65-66 | 2-Dr Hardtop | Watershield Set | 20.95 Set |

## DASH ODOMETER LENS



| Part # | Year | Model | Part          | Price     |
|--------|------|-------|---------------|-----------|
| 10383  | 58   | All   | Odometer Lens | 22.95 Ea. |

## GENERATOR/OIL GAUGE PARTS



| Part # | Year  | Model | Part                     | Price     |
|--------|-------|-------|--------------------------|-----------|
| 10391  | 59-60 | All   | Generator/Oil Gauge Lens | 42.95 Ea. |

## SPEEDOMETER PARTS



10376



10388



10396



13054



13055



15297

| Part # | Year  | Model | Part             | Price      |
|--------|-------|-------|------------------|------------|
| 10376  | 58    | All   | Speedometer Lens | 68.95 Ea.  |
| 10388  | 59-60 | All   | Speedometer Lens | 64.95 Ea.  |
| 10396  | 61-62 | All   | Speedometer Lens | 42.95 Ea.  |
| 13054  | 63    | All   | Speedometer Lens | 69.95 Ea.  |
| 13055  | 64    | All   | Speedometer Lens | 69.95 Ea.  |
| 16151  | 65    | All   | Speedometer Lens | 119.95 Ea. |
| 16015  | 63    | All   | Speedometer      | 289.95 Ea. |
| 15297  | 64    | All   | Speedometer      | 289.95 Ea. |
| 16016  | 65    | All   | Speedometer      | 289.95 Ea. |

## DASH RADIO LENS



| Part # | Year | Model | Part                   | Price     |
|--------|------|-------|------------------------|-----------|
| 10384  | 58   | All   | Radio Lens (Wonderbar) | 37.95 Ea. |

## CLOCK PARTS



10379



10392



10400



15974

| Part # | Year  | Model       | Part                 | Price      |
|--------|-------|-------------|----------------------|------------|
| 10379  | 58    | All         | Dash Clock Face Lens | 42.95 Ea.  |
| 10392  | 59-60 | Westclox    | Dash Clock Face Lens | 42.95 Ea.  |
| 10393  | 59-60 | Borg Warner | Dash Clock Face Lens | 45.95 Ea.  |
| 10399  | 61-62 | Westclox    | Dash Clock Face Lens | 42.95 Ea.  |
| 10400  | 61-62 | Borg Warner | Dash Clock Face Lens | 42.95 Ea.  |
| 16129  | 65    | All         | Dash Clock Face Lens | 45.95 Ea.  |
| 15820  | 58    | All         | Dash Clock           | 159.95 Ea. |
| 15974  | 61-62 | All         | Dash Clock           | 239.95 Ea. |
| 16019  | 63    | All         | Dash Clock           | 199.95 Ea. |
| 16020  | 64    | All         | Dash Clock           | 179.95 Ea. |
| 16021  | 65    | All         | Dash Clock           | 239.95 Ea. |

## FUEL GAUGE PARTS



10377



10389



15298



15973

| Part # | Year  | Model                       | Part            | Price      |
|--------|-------|-----------------------------|-----------------|------------|
| 10377  | 58    | All                         | Fuel Gauge Lens | 42.95 Ea.  |
| 10389  | 59-60 | All                         | Fuel Gauge Lens | 42.95 Ea.  |
| 10397  | 61-62 | All                         | Fuel Gauge Lens | 42.95 Ea.  |
| 16128  | 65    | w/Warning Lights            | Fuel Gauge Lens | 45.95 Ea.  |
| 15822  | 58    | All                         | Fuel Gauge      | 119.95 Ea. |
| 15298  | 64    | All                         | Fuel Gauge      | 155.95 Ea. |
| 16017  | 63    | All                         | Fuel Gauge      | 145.95 Ea. |
| 16018  | 65    | All                         | Fuel Gauge      | 145.95 Ea. |
| 15973  | 65    | w/Warning Lights            | Fuel Gauge      | 145.95 Ea. |
| 16280  | 66    | Impala/Bel Air/<br>Biscayne | Fuel Gauge      | 169.95 Ea. |

## TEMPERATURE GAUGE PARTS



10378



10390



10398

| Part # | Year  | Model  | Part                   | Price      |
|--------|-------|--------|------------------------|------------|
| 15821  | 58    | Impala | Temperature Gauge      | 119.95 Ea. |
| 10378  | 58    | All    | Temperature Gauge Lens | 42.95 Ea.  |
| 10390  | 59-60 | All    | Temperature Gauge Lens | 42.95 Ea.  |
| 10398  | 61-62 | All    | Temperature Gauge Lens | 42.95 Ea.  |

# Dash Parts



1959-'60 Classic instrument cluster is designed to fit your stock gauge pods. The set includes a 4 5/8" SpeedTachular (with built-in ECM filter signal switch) and quad gauge with temp, volt, oil pressure, and fuel gauge programmed to read the stock 0-90 OHM fuel sender. The package is ready to bolt into your dash, complete with instrument wiring harness and all necessary sending units.

## CLASSIC INSTRUMENTS GAUGES



This package will include a speedometer, optional tachometer, fuel (0-30 ohms), volts, oil, and temp gauges. It includes all necessary hardware to mount your gauges in your dash: standard Classic Instruments 5-inch mounting brackets, four 2-inch brackets, three machine screws, a polished aluminum adapter ring and all sending units. To put the finishing touch on this package, two green turn signals and a red high beam indicator have been mounted into the speedometer dial face. This package is available in five different dial face styles!

| Part # | Year  | Model    | Part                                      | Price       |
|--------|-------|----------|---|-------------|
| 15917★ | 59-60 | w/o Tach | Hot Rod Series                            | 699.95 Set  |
| 15918★ | 59-60 | w/o Tach | White Hot Series                          | 699.95 Set  |
| 15919★ | 59-60 | w/o Tach | G-Stock                                   | 699.95 Set  |
| 15920★ | 59-60 | w/o Tach | SG Series                                 | 699.95 Set  |
| 15921★ | 59-60 | w/o Tach | Vintage Series                            | 699.95 Set  |
| 16519★ | 59-60 | w/o Tach | Gauge Kit <b>(All American Nickel)</b>    | 930.95 Kit  |
| 16520★ | 59-60 | w/o Tach | Gauge Kit <b>(All American Tradition)</b> | 930.95 Kit  |
| 16521★ | 59-60 | w/o Tach | Gauge Kit <b>(All American)</b>           | 930.95 Kit  |
| 15922★ | 59-60 | w/Tach   | Hot Rod Series                            | 999.95 Set  |
| 15923★ | 59-60 | w/Tach   | White Hot Series                          | 999.95 Set  |
| 15924★ | 59-60 | w/Tach   | G-Stock                                   | 999.95 Set  |
| 15925★ | 59-60 | w/Tach   | SG Series                                 | 999.95 Set  |
| 15926★ | 59-60 | w/Tach   | Vintage Series                            | 999.95 Set  |
| 16522★ | 59-60 | w/Tach   | Gauge Kit <b>(All American Nickel)</b>    | 1143.95 Kit |
| 16523★ | 59-60 | w/Tach   | Gauge Kit <b>(All American Tradition)</b> | 1143.95 Kit |
| 16524★ | 59-60 | w/Tach   | Gauge Kit <b>(All American)</b>           | 1143.95 Kit |
| 16525★ | 59-60 | w/Tach   | Gauge Kit <b>(Autocross Gray)</b>         | 1143.95 Kit |
| 16526★ | 59-60 | w/Tach   | Gauge Kit <b>(Autocross Yellow)</b>       | 1143.95 Kit |

★ = special order non-stocking item.

## Dash Parts

### SKYDRIVE



Calibrate your speedometer in less than a minute and you don't even have to leave your driveway! Sky Drive is the world's most accurate electronic speedometer sending unit. No need for ECU convertors or pulse signal generators screwed onto your transmission. The new Sky Drive uses GPS Satellite signals to operate your electronic speedometer. It updates 10 times per second and with one push of a button it's ready to go.

| Part # | Year  | Model | Part                        | Price      |
|--------|-------|-------|-----------------------------|------------|
| 4272   | 70-72 | All   | w/Classic Instrument Guages | 249.95 Ea. |

### FUEL LINK



The Fuel Link interface is the problem-solver between fuel senders and gauges to correct ohm mismatch and erratic movement due to fuel slosh.

| Part # | Year  | Model | Part      | Price      |
|--------|-------|-------|-----------|------------|
| 4392   | 58-70 | All   | Fuel Link | 139.95 Ea. |

### SPEED SIGNAL INTERFACE



| Part # | Year  | Model                     | Part                   | Price      |
|--------|-------|---------------------------|------------------------|------------|
| 4627★  | 59-60 | All w/Classic Instruments | Speed Signal Interface | 121.95 Ea. |

### DASH TRANSMISSION INDICATORS



| Part # | Year  | Model      | Part                           | Price     |
|--------|-------|------------|--------------------------------|-----------|
| 10380  | 58    | All        | Indicator Illuminator          | 22.95 Ea. |
| 10381  | 58    | Powerglide | Transmission Indicator         | 42.95 Ea. |
| 10382  | 58    | Turboglide | Transmission Indicator         | 42.95 Ea. |
| 10394  | 59-60 | Powerglide | Transmission Indicator         | 32.95 Ea. |
| 10395  | 59-60 | Turboglide | Transmission Indicator         | 32.95 Ea. |
| 10401  | 61-62 | Powerglide | Transmission Indicator         | 30.95 Ea. |
| 10402  | 61-62 | Turboglide | Transmission Indicator         | 30.95 Ea. |
| 7258   | 64    | Powerglide | Transmission Indicator         | 8.95 Ea.  |
| 7257   | 64    | Automatic  | Transmission Indicator Housing | 11.95 Ea. |

## Dakota Digital

Since 1986, Dakota Digital has proudly designed, built and supported digital instrumentation from their Sioux Falls, South Dakota facility. Starting with the spark of an idea, plans are made; from the overall look to the internal circuitry and software. w/ plans in hand, housings, substructures and other hard parts are carved out of billet aluminum and lightweight HDPE in their fully equipped machine shop. A CNC router, several lathes and multiple CNC mills handle the dirty work. The housings are then carted across the 40,000sqft facility to the production floor, where intricate circuit boards are being populated on state of the art machines. Subassemblies featuring countless laser-cut bits are fitted to their respective housings, software is loaded, and the conglomeration of pieces is starting to look like a car part!

### DAKOTA VHX SERIES GAUGES

Fully lit needles, backlit faces, and highly visible LCD message centers are a few of the things that you can see which set the VHX Series apart from yesterday's traditional approach to instrumentation. A few of the features which you don't normally see are the micro-controlled precision stepper motors, solid state sensors for unparalleled accuracy, and user-customizable display feedback, all supported by an unrivaled limited lifetime warranty which has become the standard for Dakota Digital instrumentation systems. Completely engineered and manufactured at our facility in Sioux Falls, South Dakota, the VHX Series has completely revolutionized the instrumentation industry!



15914



16075

| Part # | Year  | Model | Part               | Price      |
|--------|-------|-------|--------------------|------------|
| 16075★ | 58    | All   | Silver Alloy Red   | 845.95 Kit |
| 16076★ | 58    | All   | Silver Alloy Blue  | 845.95 Kit |
| 16077★ | 58    | All   | Silver Alloy White | 845.95 Kit |
| 16078★ | 58    | All   | Black Alloy Red    | 845.95 Kit |
| 16079★ | 58    | All   | Black Alloy Blue   | 845.95 Kit |
| 16080★ | 58    | All   | Black Alloy White  | 845.95 Kit |
| 15911★ | 59-60 | All   | Carbon Fiber Red   | 795.95 Kit |
| 15912★ | 59-60 | All   | Carbon Fiber Blue  | 795.95 Kit |
| 15913★ | 59-60 | All   | Silver Alloy Red   | 795.95 Kit |
| 15914★ | 59-60 | All   | Silver Alloy Blue  | 795.95 Kit |
| 16081★ | 59-60 | All   | Silver Alloy White | 795.95 Kit |
| 16082★ | 59-60 | All   | Black Alloy Red    | 795.95 Kit |
| 16083★ | 59-60 | All   | Black Alloy Blue   | 795.95 Kit |
| 16084★ | 59-60 | All   | Black Alloy White  | 795.95 Kit |
| 15927★ | 61-62 | All   | Carbon Fiber Red   | 795.95 Kit |
| 15928★ | 61-62 | All   | Carbon Fiber Blue  | 795.95 Kit |
| 15929★ | 61-62 | All   | Silver Alloy Red   | 795.95 Kit |
| 15930★ | 61-62 | All   | Silver Alloy Blue  | 795.95 Kit |
| 16085★ | 61-62 | All   | Silver Alloy White | 795.95 Kit |
| 16086★ | 61-62 | All   | Black Alloy Red    | 795.95 Kit |
| 16087★ | 61-62 | All   | Black Alloy Blue   | 795.95 Kit |
| 16088★ | 61-62 | All   | Black Alloy White  | 795.95 Kit |
| 15931★ | 63-64 | All   | Carbon Fiber Red   | 795.95 Kit |
| 15932★ | 63-64 | All   | Carbon Fiber Blue  | 795.95 Kit |
| 15933★ | 63-64 | All   | Silver Alloy Red   | 795.95 Kit |
| 15934★ | 63-64 | All   | Silver Alloy Blue  | 795.95 Kit |
| 16089★ | 63-64 | All   | Silver Alloy White | 795.95 Kit |

| Part # | Year  | Model | Part               | Price      |
|--------|-------|-------|--------------------|------------|
| 16090★ | 63-64 | All   | Black Alloy Red    | 795.95 Kit |
| 16091★ | 63-64 | All   | Black Alloy Blue   | 795.95 Kit |
| 16092★ | 63-64 | All   | Black Alloy White  | 795.95 Kit |
| 16093★ | 65    | All   | Silver Alloy Red   | 845.95 Kit |
| 16094★ | 65    | All   | Silver Alloy Blue  | 845.95 Kit |
| 16095★ | 65    | All   | Silver Alloy White | 845.95 Kit |
| 16096★ | 65    | All   | Black Alloy Red    | 845.95 Kit |
| 16097★ | 65    | All   | Black Alloy Blue   | 845.95 Kit |
| 16098★ | 65    | All   | Black Alloy White  | 845.95 Kit |
| 16099★ | 66    | All   | Silver Alloy Red   | 845.95 Kit |
| 16100★ | 66    | All   | Silver Alloy Blue  | 845.95 Kit |
| 16101★ | 66    | All   | Silver Alloy White | 845.95 Kit |
| 16102★ | 66    | All   | Black Alloy Red    | 845.95 Kit |
| 16103★ | 66    | All   | Black Alloy Blue   | 845.95 Kit |
| 16104★ | 66    | All   | Black Alloy White  | 845.95 Kit |
| 16105★ | 67    | All   | Silver Alloy Red   | 845.95 Kit |
| 16106★ | 67    | All   | Silver Alloy Blue  | 845.95 Kit |
| 16107★ | 67    | All   | Silver Alloy White | 845.95 Kit |
| 16108★ | 67    | All   | Black Alloy Red    | 845.95 Kit |
| 16109★ | 67    | All   | Black Alloy Blue   | 845.95 Kit |
| 16110★ | 67    | All   | Black Alloy White  | 845.95 Kit |
| 16111★ | 68    | All   | Silver Alloy Red   | 845.95 Kit |
| 16112★ | 68    | All   | Silver Alloy Blue  | 845.95 Kit |
| 16113★ | 68    | All   | Silver Alloy White | 845.95 Kit |
| 16114★ | 68    | All   | Black Alloy Red    | 845.95 Kit |
| 16115★ | 68    | All   | Black Alloy Blue   | 845.95 Kit |
| 16116★ | 68    | All   | Black Alloy White  | 845.95 Kit |
| 16117★ | 69-70 | All   | Silver Alloy Red   | 845.95 Kit |
| 16118★ | 69-70 | All   | Silver Alloy Blue  | 845.95 Kit |
| 16119★ | 69-70 | All   | Silver Alloy White | 845.95 Kit |
| 16120★ | 69-70 | All   | Black Alloy Red    | 845.95 Kit |
| 16121★ | 69-70 | All   | Black Alloy Blue   | 845.95 Kit |
| 16122★ | 69-70 | All   | Black Alloy White  | 845.95 Kit |

★ = special order non-stocking item.

# Dash Parts

## DAKOTA DIGITAL EXPANSION MODULES

**Dakota Digital**



4589



4590

The introduction of the Dakota Digital BIM modules allow you to add up to an additional 16 gauges to your vehicle without the need to cut extra holes in the dash or installing pillar and pod mounts to your columns or under the dash.

| Part # | Year  | Model                       | Part                                  | Price      |
|--------|-------|-----------------------------|---------------------------------------|------------|
| 4553★  | 58-70 | All w/Dakota Digital Gauges | GPS Speed/Compass Sender              | 199.95 Ea. |
| 4589★  | 58-70 | All w/Dakota Digital Gauges | OB2 Speedometer/Tach Interface Module | 99.95 Ea.  |
| 4590★  | 58-70 | All w/Dakota Digital Gauges | Compass/Outside Air Temp Module       | 99.95 Ea.  |
| 4621★  | 58-70 | All w/Dakota Digital Gauges | Fast XFI Interface Module             | 99.95 Ea.  |
| 4622★  | 58-70 | All w/Dakota Digital Gauges | Holley EFI Interface Module           | 99.95 Ea.  |
| 4623★  | 58-70 | All w/Dakota Digital Gauges | Tire Pressure Monitoring System       | 399.95 Ea. |

## DAKOTA DIGITAL HDX SERIES GAUGES

**Dakota Digital**



16566



16485



16487



16490

HDX system allows the user to select their favorite illumination color for the gauge readings and needles, as well as the TFT message center displays.

| Part # | Year  | Model | Part                          | Price       |
|--------|-------|-------|-------------------------------|-------------|
| 16566★ | 58    | All   | HDX Gauge System Black Alloy  | 1295.95 Kit |
| 16567★ | 58    | All   | HDX Gauge System Silver Alloy | 1295.95 Kit |
| 16485★ | 59-60 | All   | HDX Gauge System Black Alloy  | 1295.95 Kit |
| 16486★ | 59-60 | All   | HDX Gauge System Silver Alloy | 1295.95 Kit |
| 16487★ | 61-62 | All   | HDX Gauge System Black Alloy  | 1295.95 Kit |
| 16488★ | 61-62 | All   | HDX Gauge System Silver Alloy | 1295.95 Kit |
| 16489★ | 63-64 | All   | HDX Gauge System Black Alloy  | 1295.95 Kit |
| 16490★ | 63-64 | All   | HDX Gauge System Silver Alloy | 1295.95 Kit |

## DIGITAL GAUGES



15464



15465



15466



15467



15469



15471



15472



15473



15475

Add the modern convenience of digital gauges to your classic ride without taking away it's classic look!

| Part # | Year  | Model | Part   | Price      |
|--------|-------|-------|--|------------|
| 15464★ | 58    | All   | Dakota Digital Gauges  | 725.95 Kit |
| 15465★ | 59-60 | All   | Dakota Digital Gauges  | 665.95 Kit |
| 15466  | 61-62 | All   | Dakota Digital Gauges  | 725.95 Kit |
| 15467★ | 63-64 | All   | Dakota Digital Gauges  | 725.95 Kit |
| 15468★ | 63-64 | All   | Dakota Digital Gauges w/Clock  | 795.95 Kit |
| 15469★ | 65    | All   | Dakota Digital Gauges  | 725.95 Kit |
| 15470★ | 65    | All   | Dakota Digital Gauges w/Clock  | 795.95 Kit |
| 15471★ | 66    | All   | Dakota Digital Gauges  | 725.95 Kit |
| 15472★ | 67    | All   | Dakota Digital Gauges  | 725.95 Kit |
| 15473★ | 68    | All   | Dakota Digital Gauges  | 725.95 Kit |
| 15474★ | 69-70 | All   | Dakota Digital Gauges  | 725.95 Kit |
| 15475★ | 69-70 | All   | Dakota Digital Gauges w/ Clock ( <b>Bezel And Housing Not Included</b> ) | 795.95 Kit |

★ = special order non-stocking item.

# Dash Parts

## DASH DETAIL KIT



| Part # | Year | Model | Part            | Price      |
|--------|------|-------|-----------------|------------|
| 12943  | 58   | All   | Dash Detail Kit | 129.95 Kit |

## DASH TRIM



| Part # | Year | Model     | Part                            | Price      |
|--------|------|-----------|---------------------------------|------------|
| 15225  | 61   | Impala    | Dash Fascia Trim                | 99.95 Ea.  |
| 15226  | 62   | Impala    | Dash Fascia Trim                | 99.95 Ea.  |
| 15500  | 62   | Impala    | Dash Fascia Trim Above Glovebox | 89.95 Ea.  |
| 10408  | 63   | Impala    | Dash Fascia Trim                | 80.95 Set  |
| 10409  | 63   | Impala SS | Dash Fascia Trim                | 89.95 Set  |
| 10410  | 64   | Impala    | Dash Fascia Trim                | 80.95 Set  |
| 10411  | 64   | Impala SS | Dash Fascia Trim                | 89.95 Set  |
| 13151  | 65   | Impala    | Dash Fascia Trim w/o AC         | 179.95 Set |

## DASH BEZELS



| Part # | Year  | Model  | Part                      | Price     |
|--------|-------|--------|---------------------------|-----------|
| 10385  | 58    | All    | Dash Indicator Bezel Set  | 85.95 Set |
| 10386  | 58    | All    | Radio Indicator Bezel Set | 42.95 Set |
| 10387  | 58    | All    | Speaker Indicator Bezel   | 32.95 Ea. |
| 13180  | 61-64 | Impala | Cigarette Lighter Bezel   | 6.95 Ea.  |
| 13181  | 61-64 | Impala | Headlight & Wiper Bezel   | 3.00 Ea.  |

## DASH PADS



These reproduction urethane dash pads are manufactured to original specifications and features the correct grain and texture creating an original appearance and exceptional fit.

| Part #  | Year  | Model | Part           | Price      |
|---------|-------|-------|----------------|------------|
| 16281 ① | 59-60 | All   | Dash Pad/Black | 539.95 Ea. |
| 16282 ① | 61-62 | All   | Dash Pad/Black | 299.95 Ea. |
| 16283 ① | 63-64 | All   | Dash Pad/Black | 409.95 Ea. |
| 16284 ① | 65-66 | All   | Dash Pad/Black | 349.95 Ea. |

## DASH SEALS



These reproduction urethane dash pads are manufactured to original specifications and features the correct grain and texture creating an original appearance and exceptional fit.

| Part # | Year  | Model | Part                     | Price    |
|--------|-------|-------|--------------------------|----------|
| 10404  | 59-60 | All   | Speedometer Housing Seal | 6.95 Ea. |
| 10405  | 61-62 | All   | Gauge Panel To Dash Seal | 7.95 Ea. |

## TACHOMETER PARTS



| Part # | Year  | Model  | Part                           | Price      |
|--------|-------|--------|--------------------------------|------------|
| 10403  | 62-64 | All    | Tachometer Face                | 42.95 Ea.  |
| 10406  | 63-64 | w/Tach | Dash Mounted Tach Housing Seal | 7.95 Ea.   |
| 15123  | 63-64 | All    | Dash Tach Kit (6000 Rpm)       | 275.95 Kit |
| 15124  | 63-64 | All    | Dash Tach Kit (7000 Rpm)       | 275.95 Kit |

① = add \$8.95 handling per item

# Decals

## AIR CLEANER DECALS



| Part# | Year  | Model          | Part                   | Price    |
|-------|-------|----------------|------------------------|----------|
| 5118  | 58    | 283/348        | Air Cleaner Decal      | 4.00 Ea. |
| 5117  | 58-61 | 6-Cylinder     | Air Cleaner Decal      | 4.00 Ea. |
| 1005  | 58-61 | W/Fuel Inj     | Air Cleaner Decal      | 4.00 Ea. |
| 10450 | 58-66 | All            | Oil Bath Warning Decal | 4.00 Ea. |
| 10420 | 59-61 | 283/348        | Air Cleaner Decal      | 4.00 Ea. |
| 10428 | 60-61 | 348 3X2-Barrel | Air Cleaner Decal      | 4.00 Ea. |
| 10427 | 63    | 327 300Hp      | Air Cleaner Decal      | 4.00 Ea. |
| 10445 | 63    | 409            | Flag Air Cleaner Decal | 5.00 Ea. |
| 10446 | 64-65 | 409 340Hp      | Flag Air Cleaner Decal | 5.00 Ea. |
| 10447 | 64-65 | 409 400Hp      | Flag Air Cleaner Decal | 5.00 Ea. |
| 10438 | 65    | 396 375Hp      | Cross Flag Decal       | 5.00 Ea. |
| 10439 | 65    | 396 450Hp      | Cross Flag Decal       | 5.00 Ea. |
| 10440 | 65    | 396 325Hp      | Turbo-Fire Decal       | 4.00 Ea. |
| 10456 | 65    | 375Hp          | Turbo-Jet Decal        | 4.00 Ea. |
| 10459 | 65    | 390Hp          | Turbo-Jet Decal        | 4.00 Ea. |
| 10436 | 65-66 | 396 425Hp      | Air Cleaner Decal      | 4.00 Ea. |
| 10452 | 65-68 | 325Hp          | Turbo-Jet Decal        | 4.00 Ea. |
| 10460 | 65-69 | 425Hp          | Turbo-Jet Decal        | 4.00 Ea. |
| 10437 | 65-69 | 396            | Cross Flag Decal       | 4.00 Ea. |
| 10448 | 65-69 | 427            | Cross Flag Decal       | 4.00 Ea. |
| 10458 | 66    | 390Hp          | Turbo-Jet Decal        | 4.00 Ea. |
| 10419 | 67    | 283/195 Hp     | Turbo-Fire Decal       | 4.00 Ea. |
| 10425 | 67-68 | 327 275Hp      | Turbo-Fire Decal       | 4.00 Ea. |
| 10457 | 67-68 | 385Hp          | Turbo-Jet Decal        | 4.00 Ea. |

| Part# | Year  | Model                | Part                | Price    |
|-------|-------|----------------------|---------------------|----------|
| 10413 | 67-70 | 250 6-Cylinder       | Turbo Thrift 155Hp  | 4.00 Ea. |
| 10414 | 68    | 250 6-Cylinder At    | Keep Your Gm All Gm | 4.00 Ea. |
| 10417 | 68    | 250 6-Cylinder Mt    | Keep Your Gm All Gm | 4.00 Ea. |
| 10421 | 68    | 307 Turbo            | Turbo-Fire Decal    | 4.00 Ea. |
| 10424 | 68    | 327 250Hp            | Turbo-Fire Decal    | 4.00 Ea. |
| 10423 | 69    | 327 235Hp            | Turbo-Fire Decal    | 4.00 Ea. |
| 10430 | 69    | 350 255Hp            | Turbo-Fire Decal    | 4.00 Ea. |
| 10416 | 69    | 250 6-Cylinder At/Mt | Keep Your Gm All Gm | 4.00 Ea. |
| 10434 | 69    | 350 255Hp            | Keep Your Gm All Gm | 4.00 Ea. |
| 10435 | 69    | 350 300Hp            | Keep Your Gm All Gm | 4.00 Ea. |
| 10451 | 69    | 265Hp                | Turbo-Jet Decal     | 4.00 Ea. |
| 10453 | 69    | 335Hp                | Turbo-Jet Decal     | 4.00 Ea. |
| 10455 | 69    | 355Hp                | Turbo-Jet Decal     | 4.00 Ea. |
| 10429 | 69-70 | 350 250Hp            | Turbo-Fire Decal    | 4.00 Ea. |
| 10431 | 69-70 | 350 300Hp            | Turbo-Fire Decal    | 4.00 Ea. |
| 10432 | 70    | 307                  | Keep Your Gm All Gm | 4.00 Ea. |
| 10433 | 70    | 350 250Hp            | Keep Your Gm All Gm | 4.00 Ea. |
| 10442 | 70    | 400                  | Keep Your Gm All Gm | 4.00 Ea. |
| 10443 | 70    | 400 255Hp            | Turbo-Fire Decal    | 4.00 Ea. |
| 10421 | 70    | 307 Turbo            | Turbo-Fire Decal    | 4.95 Ea. |
| 10454 | 70    | 345Hp                | Turbo-Jet Decal     | 4.00 Ea. |
| 10449 | 70    | 454                  | Cross Flag Decal    | 4.00 Ea. |

## AIR CLEANER SERVICE DECALS



| Part# | Year  | Model          | Part          | Price    |
|-------|-------|----------------|---------------|----------|
| 10412 | 64-66 | 230 6-Cylinder | Service Decal | 4.00 Ea. |
| 10415 | 67    | 250 6-Cylinder | Service Decal | 4.00 Ea. |
| 10418 | 67    | 283 195Hp      | Service Decal | 4.00 Ea. |
| 10422 | 68    | 307 200Hp      | Service Decal | 4.00 Ea. |
| 10426 | 66    | 327 275Hp      | Service Decal | 4.00 Ea. |
| 10426 | 69-70 | 327 275Hp      | Service Decal | 4.95 Ea. |
| 10441 | 65-67 | 396 325Hp      | Service Decal | 4.00 Ea. |
| 10444 | 61-62 | 409 2X4-Barrel | Service Decal | 4.00 Ea. |

## AC COMPRESSOR DECALS



| Part# | Year  | Model | Part                         | Price    |
|-------|-------|-------|------------------------------|----------|
| 10487 | 63-65 | All   | AC Compressor Decal          | 5.00 Ea. |
| 10488 | 66    | All   | AC Compressor Decal (Green)  | 5.00 Ea. |
| 5161  | 66    | All   | AC Compressor Decal (Red)    | 5.00 Ea. |
| 10489 | 67-68 | All   | AC Compressor Decal (Green ) | 5.00 Ea. |
| 10490 | 67    | All   | AC Compressor Decal (Orange) | 5.00 Ea. |
| 5162  | 67    | All   | AC Compressor Decal (Red)    | 5.00 Ea. |
| 5163  | 68    | All   | AC Compressor Decal (Red)    | 5.00 Ea. |
| 5164  | 69    | All   | AC Compressor Decal (Red)    | 5.00 Ea. |
| 10491 | 69-70 | All   | AC Compressor Decal (Green)  | 5.00 Ea. |

# Decals

## AC EVAPORATOR BOX DECALS



10492



5170



5173

| Part # | Year  | Model | Part                    | Price    |
|--------|-------|-------|-------------------------|----------|
| 10492  | 58-64 | All   | AC Evaporator Box Decal | 6.95 Ea. |
| 5168   | 65    | All   | AC Evaporator Box Decal | 4.00 Ea. |
| 5169   | 66    | All   | AC Evaporator Box Decal | 4.00 Ea. |
| 5170   | 67    | All   | AC Evaporator Box Decal | 4.00 Ea. |
| 5171   | 68    | All   | AC Evaporator Box Decal | 4.50 Ea. |
| 5172   | 69    | All   | AC Evaporator Box Decal | 4.50 Ea. |
| 5173   | 70    | All   | AC Evaporator Box Decal | 4.50 Ea. |

## BATTERY DECALS



5149



5150



1042

| Part # | Year  | Model | Part                         | Price    |
|--------|-------|-------|------------------------------|----------|
| 5149   | 62-63 | All   | Battery Caution Decal        | 4.00 Ea. |
| 5150   | 64-66 | All   | Battery Caution Decal        | 4.00 Ea. |
| 1042   | 58-65 | All   | Battery Warranty Certificate | 4.00 Ea. |

## OIL SYSTEM DECALS



5147



5148



10462

| Part # | Year  | Model | Part                 | Price    |
|--------|-------|-------|----------------------|----------|
| 5147   | 58-63 | All   | Oil Filler Cap Decal | 4.00 Ea. |
| 5148   | 64-67 | All   | Oil Filler Cap Decal | 4.00 Ea. |
| 10462  | 58-64 | All   | Oil Filter Decal     | 4.95 Ea. |

## COOLING SYSTEM DECALS



1014



5151



10461

| Part # | Year  | Model | Part                               | Price    |
|--------|-------|-------|------------------------------------|----------|
| 1014   | 58-64 | All   | Anti-Freeze Tag                    | 4.00 Ea. |
| 5151   | 60-70 | All   | Anti-Freeze Dealer Installed Decal | 4.00 Ea. |
| 5152   | 61-64 | All   | Cooling System Caution Decal       | 4.00 Ea. |
| 10461  | 65-66 | All   | Cooling System Caution Decal       | 4.95 Ea. |
| 5153   | 67-69 | All   | Cooling System Caution Decal       | 4.00 Ea. |
| 5154   | 70    | All   | Cooling System Caution Decal       | 4.00 Ea. |

## EMISSION DECALS



10469



10473

| Part # | Year | Model  | Part           | Price    |
|--------|------|--|----------------|----------|
| 10469  | 68   | 250 155Hp Automatic Transmission                 | Emission Decal | 4.50 Ea. |
| 10470  | 68   | 250 155Hp Manual Transmission                    | Emission Decal | 4.50 Ea. |
| 10471  | 68   | 307 200Hp Automatic Transmission                 | Emission Decal | 4.50 Ea. |
| 10472  | 68   | 307 200Hp Manual Transmission                    | Emission Decal | 4.50 Ea. |
| 10473  | 68   | 327 Automatic                                    | Emission Decal | 4.50 Ea. |
| 10474  | 68   | 327 250Hp Manual Transmission                    | Emission Decal | 4.50 Ea. |
| 10475  | 68   | 327 275Hp Manual Transmission                    | Emission Decal | 4.50 Ea. |
| 10473  | 68   | 396 325Hp Automatic Transmission                 | Emission Decal | 4.50 Ea. |
| 10475  | 68   | 396 325Hp Manual Transmission                    | Emission Decal | 4.50 Ea. |
| 10473  | 68   | 427 385Hp Automatic Transmission                 | Emission Decal | 4.50 Ea. |
| 10475  | 68   | 427 385Hp Manual Transmission                    | Emission Decal | 4.50 Ea. |
| 10476  | 68   | 427 425Hp Manual Transmission                    | Emission Decal | 4.50 Ea. |
| 10477  | 69   | 155Hp Automatic Transmission/Manual Transmission | Emission Decal | 4.50 Ea. |
| 10478  | 69   | 250Hp Automatic Transmission/Manual Transmission | Emission Decal | 4.50 Ea. |
| 10479  | 69   | 265Hp Automatic Transmission/Manual Transmission | Emission Decal | 4.50 Ea. |
| 10480  | 69   | 300Hp Automatic Transmission/Manual Transmission | Emission Decal | 4.50 Ea. |
| 10481  | 69   | 390Hp Automatic Transmission/Manual Transmission | Emission Decal | 4.50 Ea. |
| 10482  | 69   | 425Hp Automatic Transmission/Manual Transmission | Emission Decal | 4.50 Ea. |
| 5178   | 70   | 155Hp Automatic Transmission/Manual Transmission | Emission Decal | 4.50 Ea. |
| 10483  | 70   | 200Hp Automatic Transmission/Manual Transmission | Emission Decal | 4.50 Ea. |
| 5176   | 70   | 250Hp Automatic Transmission/Manual Transmission | Emission Decal | 4.50 Ea. |
| 5179   | 70   | 307 200Hp  | Emission Decal | 4.50 Ea. |
| 10484  | 70   | 345Hp  | Emission Decal | 4.50 Ea. |
| 10485  | 70   | 345/390 Hp                                       | Emission Decal | 4.50 Ea. |
| 5180   | 70   | 350 250Hp  | Emission Decal | 4.50 Ea. |
| 10486  | 70   | 390Hp Automatic Transmission/Manual Transmission | Emission Decal | 4.50 Ea. |

# Decals

## GLOVE BOX DECALS



| Part # | Year  | Model                           | Part                | Price    |
|--------|-------|---------------------------------|---------------------|----------|
| 10519  | 62    | All                             | AC Operation Decal  | 4.00 Ea. |
| 10520  | 63    | All                             | AC Operation Decal  | 4.00 Ea. |
| 10521  | 58-59 | All                             | Paint Door Decal    | 4.00 Ea. |
| 10517  | 58-59 | All                             | Compass Decal       | 4.95 Ea. |
| 1017   | 58-63 | All                             | Tire Pressure Decal | 3.00 Ea. |
| 10522  | 64-65 | All                             | Tire Pressure Decal | 4.00 Ea. |
| 10523  | 66    | All                             | Tire Pressure Decal | 4.00 Ea. |
| 10524  | 67    | All                             | Tire Pressure Decal | 4.00 Ea. |
| 10525  | 68    | Non-Convertible & Impala SS 427 | Tire Pressure Decal | 4.00 Ea. |
| 10526  | 68    | Impala SS 427                   | Tire Pressure Decal | 4.00 Ea. |
| 10527  | 68    | Convertible Except In Canada    | Tire Pressure Decal | 4.00 Ea. |
| 10528  | 68    | Canada Convertible              | Tire Pressure Decal | 4.50 Ea. |
| 10529  | 69-70 | All                             | Tire Pressure Decal | 4.00 Ea. |

## MISCELLANEOUS UNDER HOOD DECALS



| Part # | Year  | Model | Part                             | Price    |
|--------|-------|-------|----------------------------------|----------|
| 1016   | 58-62 | All   | Generator Warning Tag            | 3.00 Ea. |
| 10463  | 59-65 | All   | Crankcase Vent Instruction Tag   | 4.00 Ea. |
| 10464  | 62-66 | All   | Cruise Control Instruction Decal | 4.00 Ea. |
| 10465  | 67-69 | All   | Cruise Control Instruction Decal | 4.00 Ea. |
| 10466  | 64-66 | All   | Cruise Control Instruction Tag   | 4.00 Ea. |
| 10467  | 67-69 | All   | Cruise Control Instruction Tag   | 4.00 Ea. |
| 10468  | 70    | All   | Cruise Control Instruction Tag   | 4.00 Ea. |

## RADIO DECALS & TAGS



| Part # | Year  | Model | Part                           | Price    |
|--------|-------|-------|--------------------------------|----------|
| 10511  | 63-65 | All   | AM/FM Radio Reception Tag      | 4.00 Ea. |
| 10512  | 66-67 | All   | AM/FM Radio Reception Card     | 4.00 Ea. |
| 10513  | 68    | All   | AM/FM Stereo Adapter Sheet     | 4.00 Ea. |
| 10514  | 69    | All   | AM/FM Stereo Adapter Sheet     | 4.00 Ea. |
| 1044   | 58-60 | All   | Radio Antenna Adjustment Decal | 4.00 Ea. |

## WINDSHIELD WASHER DECALS



| Part # | Year  | Model | Part                               | Price    |
|--------|-------|-------|------------------------------------|----------|
| 10577  | 58-60 | All   | Windshield Washer Adjustment Decal | 4.00 Ea. |
| 10578  | 61-62 | All   | Windshield Washer Adjustment Decal | 4.00 Ea. |
| 5156   | 58-60 | All   | Windshield Washer Bracket Decal    | 4.00 Ea. |
| 5157   | 61-67 | All   | Washer Bottle Decal (Kleerview)    | 4.00 Ea. |
| 5158   | 61-67 | All   | Washer Bottle Decal (Optikleen)    | 4.00 Ea. |
| 1012   | 58-60 | All   | Washer Lid Decal (Automatic)       | 4.00 Ea. |
| 1013   | 58-60 | All   | Washer Lid Decal (Manual)          | 4.00 Ea. |

## WINDOW AC DECALS



| Part # | Year  | Model | Part                         | Price    |
|--------|-------|-------|------------------------------|----------|
| 1046   | 58-61 | All   | Window Air Conditioned Decal | 4.00 Ea. |
| 10573  | 62-65 | All   | Window Air Conditioned Decal | 4.00 Ea. |
| 10574  | 66-67 | All   | Window Air Conditioned Decal | 4.00 Ea. |
| 10575  | 68-69 | All   | Window Air Conditioned Decal | 4.00 Ea. |
| 10576  | 68-70 | All   | Window Confortron AC Decal   | 4.50 Ea. |

## WINDOW PRICE STICKERS

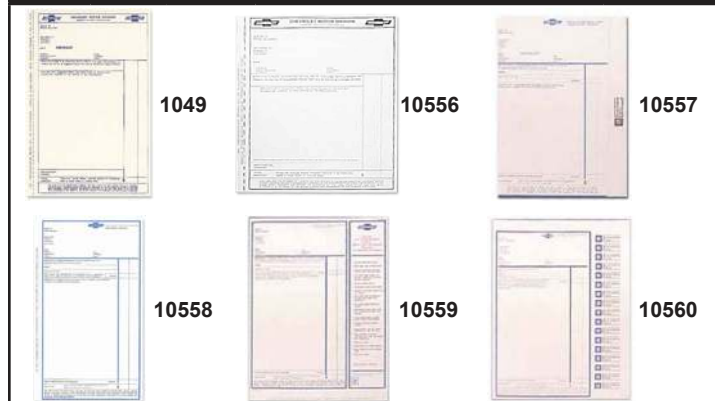

| Part # | Year  | Model | Part                 | Price    |
|--------|-------|-------|----------------------|----------|
| 1049   | 58-59 | All   | Window Price Sticker | 5.00 Ea. |
| 10555  | 60    | All   | Window Price Sticker | 4.50 Ea. |
| 10556  | 61-65 | All   | Window Price Sticker | 4.50 Ea. |
| 10557  | 66-67 | All   | Window Price Sticker | 4.50 Ea. |
| 10558  | 68    | All   | Window Price Sticker | 4.50 Ea. |
| 10559  | 69    | All   | Window Price Sticker | 4.50 Ea. |
| 10560  | 70    | All   | Window Price Sticker | 4.50 Ea. |

# Decals

## VALVE COVER DECALS



| Part # | Year  | Model          | Part                              | Price     |
|--------|-------|----------------|-----------------------------------|-----------|
| 1008   | 58    | 6-Cylinder     | Blue Flame 140 Decal              | 4.00 Ea.  |
| 5126   | 59-61 | 6-Cylinder     | Hi-Thrift Decal                   | 4.00 Ea.  |
| 10505  | 61-64 | 409            | Turbo-Fire Decal                  | 4.00 Ea.  |
| 10506  | 61    | 380Hp          | Valve Cover Decal (Use w/ #10505) | 4.00 Ea.  |
| 10507  | 62    | 380Hp          | Valve Cover Decal (Use w/ #10505) | 4.00 Ea.  |
| 10508  | 62    | 409Hp          | Valve Cover Decal (Use w/ #10505) | 4.00 Ea.  |
| 10497  | 62-63 | 283            | Turbo-Fire Decal                  | 4.00 Ea.  |
| 10500  | 62-65 | 327            | Turbo-Fire Decal                  | 4.00 Ea.  |
| 10501  | 62-65 | 300Hp          | Valve Cover Decal (Use w/ #10500) | 4.00 Pair |
| 10495  | 63-65 | 250Hp          | Valve Cover Decal (Use w/ #10500) | 4.00 Pair |
| 10493  | 63    | 230 6-Cylinder | Turbo-Thrift Decal                | 4.95 Ea.  |
| 10503  | 63    | 340Hp          | Valve Cover Decal                 | 4.00 Ea.  |
| 10504  | 63    | 400Hp          | Valve Cover Decal                 | 4.00 Pair |
| 10509  | 63-64 | 425Hp          | Valve Cover Decal                 | 4.00 Ea.  |
| 10510  | 64-65 | 140Hp          | Turbo-Thrift Decal                | 4.00 Ea.  |
| 10498  | 64-66 | 283 195Hp      | Turbo-Fire Decal                  | 4.00 Ea.  |
| 10499  | 64-66 | 283 220Hp      | Turbo-Fire Decal                  | 4.00 Ea.  |
| 10494  | 65    | 230 6-Cylinder | Turbo-Thrift Decal                | 4.95 Ea.  |
| 10496  | 66    | 250 155Hp      | Turbo-Thrift Decal                | 4.00 Ea.  |
| 10502  | 66    | 327 275Hp      | Turbo-Fire Decal                  | 4.00 Ea.  |
| 5144   | 68-70 | All            | Tonawanda #1 Decal                | 4.00 Ea.  |

## OWNERS MANUAL ENVELOPES & BAGS



| Part # | Year  | Model | Part              | Price    |
|--------|-------|-------|-------------------|----------|
| 10563  | 69-70 | All   | Owners Manual Bag | 5.50 Ea. |

## JACK INSTRUCTION DECALS

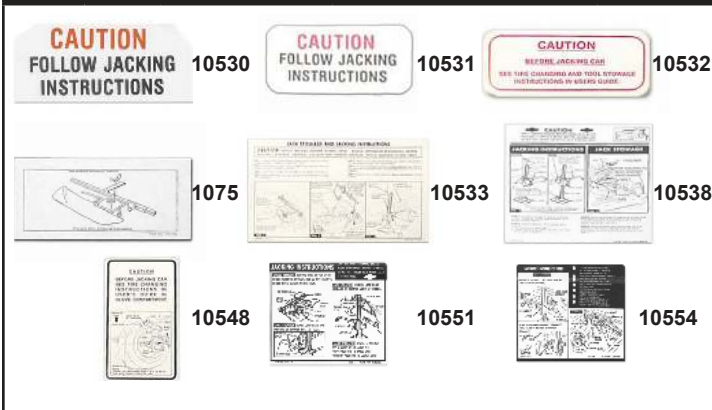

| Part # | Year  | Model                     | Part                      | Price    |
|--------|-------|---------------------------|---------------------------|----------|
| 10530  | 59-61 | All                       | Jack Base Caution Decal   | 4.00 Ea. |
| 10531  | 62-64 | All                       | Jack Base Caution Decal   | 4.00 Ea. |
| 10532  | 62-64 | All                       | Caution Jack Decal        | 4.00 Ea. |
| 1075   | 58-61 | All                       | Continental Kit Tire Stow | 3.50 Ea. |
| 10533  | 58    | Hardtop/Sedan/Convertible | Jack Instruct Decal       | 4.00 Ea. |
| 10534  | 59    | Hardtop/Sedan/Convertible | Jack Instruct Decal       | 4.00 Ea. |
| 10535  | 60    | Hardtop/Sedan/Convertible | Jack Instruct Decal       | 4.00 Ea. |
| 10536  | 61    | Hardtop/Sedan/Convertible | Jack Instruct Decal       | 4.00 Ea. |
| 10537  | 62    | Hardtop/Convertible       | Jack Instruct Decal       | 4.00 Ea. |
| 10538  | 62    | Convertible               | Jack Instruct Decal       | 4.00 Ea. |
| 10539  | 63    | Hardtop/Sedan             | Jack Instruct Decal       | 4.00 Ea. |
| 10540  | 63    | Convertible               | Jack Instruct Decal       | 4.00 Ea. |
| 10541  | 63    | Wagon                     | Jack Instruct Decal       | 4.00 Ea. |
| 10542  | 64    | Hardtop/Sedan             | Jack Instruct Decal       | 4.00 Ea. |
| 10543  | 64    | Convertible               | Jack Instruct Decal       | 4.00 Ea. |
| 10544  | 65    | Hardtop/Sedan             | Jack Instruct Decal       | 4.00 Ea. |
| 10545  | 65    | Convertible               | Jack Instruct Decal       | 4.00 Ea. |
| 10546  | 66    | Hardtop/Sedan             | Jack Instruct Decal       | 4.00 Ea. |
| 10547  | 66    | Convertible               | Jack Instruct Decal       | 4.00 Ea. |
| 10548  | 66    | Canada                    | Jack Instruct Decal       | 4.50 Ea. |
| 10549  | 67    | Hardtop/Convertible       | Jack Instruct Decal       | 4.00 Ea. |
| 10550  | 67    | Convertible               | Jack Instruct Decal       | 4.00 Ea. |
| 10551  | 68    | Hardtop/Sedan             | Jack Instruct Decal       | 4.00 Ea. |
| 10552  | 68    | Convertible               | Jack Instruct Decal       | 4.0 Ea.  |
| 10553  | 69    | Hardtop/Sedan             | Jack Instruct Decal       | 4.00 Ea. |
| 10554  | 70    | Hardtop/Sedan             | Jack Instruct Decal       | 4.00 Ea. |

# Decals / Distributor / Dome Lights / Door Parts

## MISCELLANEOUS INTERIOR DECALS



| Part # | Year  | Model       | Part                                  | Price    |
|--------|-------|-------------|---------------------------------------|----------|
| 10515  | 58-59 | All         | Autoronic Eye Instruction Tag         | 4.00 Ea. |
| 1021   | 58-59 | All         | Casco Lighter Instruction Tag         | 4.00 Ea. |
| 1022   | 60    | All         | Lighter Instruction Tag               | 4.00 Ea. |
| 10516  | 62    | All         | Day/Night Mirror Instruction Tag      | 4.00 Ea. |
| 1020   | 58-59 | All         | Chrome Cage Instruction Tag           | 4.00 Ea. |
| 10518  | 64-66 | Convertible | Convertible Top Warning Decal         | 4.00 Ea. |
| 1019   | 58    | All         | Lacquer Paint Instruction Card        | 4.00 Ea. |
| 1055   | 58-63 | All         | Positraction Warning Decal            | 4.00 Ea. |
| 10564  | 64-70 | All         | Positraction Warning Decal            | 4.00 Ea. |
| 10565  | 61-63 | All         | Seat Belt Decal                       | 4.00 Ea. |
| 10566  | 63    | All         | Seat Belt Instruction Decal           | 4.00 Ea. |
| 10567  | 64-66 | All         | Seat Belt Instruction Decal           | 4.00 Ea. |
| 10568  | 69-70 | All         | Sunvisor Starting Sleeve 6"           | 4.50 Ea. |
| 10569  | 69-70 | All         | Sunvisor Starting Sleeve 7"           | 4.50 Ea. |
| 10570  | 59-60 | All         | Sunvisor Tire Pressure & Brake Sleeve | 4.50 Ea. |
| 10571  | 64-72 | All         | Transistor Ignition Amp Decal         | 4.00 Ea. |
| 10572  | 64-72 | All         | Transistor Ignition Coil Decal        | 4.00 Ea. |

## DISTRIBUTOR PARTS

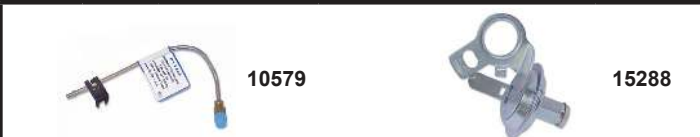

| Part # | Year  | Model                     | Part                | Price     |
|--------|-------|---------------------------|---------------------|-----------|
| 10579  | 59-64 | 327 350Hp                 | Vacuum Line         | 16.95 Ea. |
| 15288  | 58-59 | 6-Cylinder                | Vacuum Advance      | 45.95 Ea. |
| 15653  | 64-70 | Small Block/<br>Big Block | Dist Holddown Clamp | 12.95 Ea. |
| 15654  | 65-70 | Small Block/<br>Big Block | Coil Bracket        | 18.95 Ea. |

## DOME LIGHT ASSEMBLIES



| Part # | Year  | Model          | Part                | Price     |
|--------|-------|----------------|---------------------|-----------|
| 13209  | 58    | 2/4-Dr Hardtop | Dome Light Assembly | 34.95 Ea. |
| 13209  | 59-61 | 2/4-Dr Hardtop | Dome Light Assembly | 34.95 Ea. |
| 10584  | 62-66 | 2-Dr Hardtop   | Dome Light Assembly | 39.95 Ea. |
| 13209  | 62-68 | 4-Dr Hardtop   | Dome Light Assembly | 34.95 Ea. |

## DOME LIGHT SWITCHES



| Part # | Year  | Model | Part              | Price     |
|--------|-------|-------|-------------------|-----------|
| 10585  | 58-62 | All   | Dome Light Switch | 35.95 Ea. |
| 16271  | 63-70 | All   | Dome Light Switch | 11.95 Ea. |

## DOME LIGHT LENSES



| Part # | Year  | Model           | Part                   | Price    |
|--------|-------|-----------------|------------------------|----------|
| 10580  | 58    | 2/4-Dr Hardtop  | Dome Light Lens        | 7.95 Ea. |
| 680    | 58-62 | Belair/Biscayne | Dome Light Lens        | 7.95 Ea. |
| 10580  | 59-61 | 2/4-Dr Hardtop  | Dome Light Lens        | 7.95 Ea. |
| 10580  | 62-68 | 4-Dr Hardtop    | Dome Light Lens        | 7.95 Ea. |
| 10582  | 62-66 | 2-Dr Hardtop    | Rear Quarter Lamp Lens | 5.00 Ea. |

## DOME LIGHT BEZELS & HOUSINGS



| Part # | Year  | Model           | Part                    | Price     |
|--------|-------|-----------------|-------------------------|-----------|
| 679    | 58-62 | Belair/Biscayne | Dome Light Bezel        | 14.95 Ea. |
| 10583  | 62-66 | 2-Dr Hardtop    | Rear Quarter Lamp Bezel | 55.95 Ea. |
| 1188   | 59-72 | Wagon           | Dome Light Housing      | 36.95 Ea. |

## DOOR HINGE PARTS



| Part # | Year  | Model | Part                                  | Price      |
|--------|-------|-------|---------------------------------------|------------|
| 15625  | 62-64 | All   | Upper Door Hinge LH/RH                | 109.95 Ea. |
| 15626  | 62-64 | All   | Lower Door Hinge LH                   | 119.95 Ea. |
| 15627  | 62-64 | All   | Lower Door Hinge RH                   | 119.95 Ea. |
| 10625  | 69-72 | All   | Lower Door Hinge LH/RH                | 159.95 Ea. |
| 12828  | 62-69 | All   | Door Hinge Pin Kit<br>(Does One Side) | 12.95 Kit  |
| 16069  | 61-64 | All   | Lower Door Hinge Spring               | 5.00 Ea.   |

# Door Parts

## INSIDE DOOR HANDLE MECHANISMS



| Part # | Year  | Model | Part                     | Price     |
|--------|-------|-------|--------------------------|-----------|
| 15498  | 59-64 | All   | Door Handle Mechanism LH | 19.95 Ea. |
| 15499  | 59-64 | All   | Door Handle Mechanism RH | 19.95 Ea. |

## OUTSIDE DOOR HANDLE GASKETS



| Part # | Year  | Model | Part                     | Price    |
|--------|-------|-------|--------------------------|----------|
| 10609  | 58    | All   | Door Handle/Lock Gaskets | 5.95 Set |
| 10610  | 59    | All   | Door Handle/Lock Gaskets | 4.95 Set |
| 10611  | 60    | All   | Door Handle/Lock Gaskets | 4.95 Set |
| 10612  | 61-62 | All   | Door Handle/Lock Gaskets | 4.95 Set |
| 10613  | 63-64 | All   | Door Handle/Lock Gaskets | 4.95 Set |
| 15205  | 65-68 | All   | Door Handle/Lock Gaskets | 4.00 Set |
| 10614  | 69-70 | All   | Door Handle/Lock Gaskets | 5.00 Set |

## OUTSIDE DOOR HANDLE GUARDS



| Part # | Year  | Model | Part               | Price      |
|--------|-------|-------|--------------------|------------|
| 10606  | 58    | All   | Door Handle Guards | 39.95 Pair |
| 10607  | 59    | All   | Door Handle Guards | 40.95 Pair |
| 10608  | 60-61 | All   | Door Handle Guards | 27.95 Pair |
| 10608  | 63-64 | All   | Door Handle Guards | 27.95 Pair |

## INSIDE DOOR HANDLES



| Part # | Year  | Model           | Part                    | Price      |
|--------|-------|-----------------|-------------------------|------------|
| 12935  | 58    | Impala          | Inside Door Handle      | 22.95 Ea.  |
| 10586  | 58-60 | Belair/Biscayne | Inside Door Handle      | 11.95 Ea.  |
| 16002  | 61-64 | Belair          | Inside Door Handle      | 28.95 Ea.  |
| 10586  | 61-64 | Biscayne        | Inside Door Handle      | 11.95 Ea.  |
| 10587  | 65-67 | Belair/Biscayne | Inside Door Handle      | 14.95 Ea.  |
| 10588  | 59-67 | Impala/Caprice  | Inside Door Handle      | 49.95 Pair |
| 10589  | 68-70 | All             | Inside Door Handle LH   | 13.95 Ea.  |
| 10590  | 68-70 | All             | Inside Door Handle RH   | 13.95 Ea.  |
| 220    | 58-72 | All             | Plastic Handle Washer   | 1.50 Ea.   |
| 12938  | 58    | Impala          | Handle Escutcheon Bezel | 13.95 Ea.  |

## BILLET ALUMINUM OUTSIDE DOOR HANDLES



| Part # | Year | Model | Part   | Price       |
|--------|------|-------|--|-------------|
| 16259★ | 60   | All   | Billet Alum Door Handles Smooth Finish/Polished      | 285.95 Pair |
| 16261★ | 60   | All   | Billet Alum Door Handles Smooth Finish/Black         | 300.95 Pair |
| 16262★ | 60   | All   | Billet Alum Door Handles Accent Finish/Polished      | 300.95 Pair |
| 16264★ | 60   | All   | Billet Alum Door Handles Accent Finish/Black         | 315.95 Pair |
| 16265★ | 60   | All   | Billet Alum Door Handles Ball Milled Finish/Polished | 339.95 Pair |
| 16267★ | 60   | All   | Billet Alum Door Handles Ball Milled Finish/Black    | 339.95 Pair |

## DOOR LOCK SETS



| Part # | Year  | Model | Part                          | Price      |
|--------|-------|-------|-------------------------------|------------|
| 1887   | 55-70 | All   | Door Lock Gaskets             | 1.50 Pair  |
| 1890   | 58    | All   | Door Lock Set (Short Pawl)    | 40.95 Pair |
| 11258  | 58    | All   | Door Lock Set (Long Pawl)     | 35.95 Pair |
| 11259  | 59-60 | All   | Door Lock Set (Long Cylinder) | 42.95 Pair |
| 11260  | 61-64 | All   | Door Lock Set (Flat Pawl)     | 36.95 Pair |
| 11261  | 61-64 | All   | Door Lock Set (Long Pawl)     | 31.95 Pair |
| 11262  | 65-66 | All   | Door Lock Set                 | 29.95 Pair |
| 11263  | 67-68 | All   | Door Lock Set                 | 27.95 Pair |
| 11264  | 69-70 | All   | Door Lock Set                 | 22.95 Pair |

## IGNITION / DOOR LOCK SETS



| Part # | Year  | Model | Part                              | Price     |
|--------|-------|-------|-----------------------------------|-----------|
| 1068   | 58    | All   | Ignition/Lock Set (Short Pawl)    | 55.95 Set |
| 11235  | 58    | All   | Ignition/Lock Set (Long Pawl)     | 52.95 Set |
| 11236  | 59-60 | All   | Ignition/Lock Set (Long Cylinder) | 55.95 Set |
| 11237  | 61-64 | All   | Ignition/Lock Set (Short Pawl)    | 55.95 Set |
| 11235  | 61-64 | All   | Ignition/Lock Set (Long Pawl)     | 52.95 Set |
| 11238  | 65    | All   | Ignition/Lock Set                 | 52.95 Set |
| 11239  | 66-67 | All   | Ignition/Lock Set                 | 39.95 Set |
| 11241  | 69-70 | All   | Ignition/Lock Set                 | 35.95 Set |

★ = special order non-stocking item

# Door Parts

## OUTSIDE DOOR HANDLES

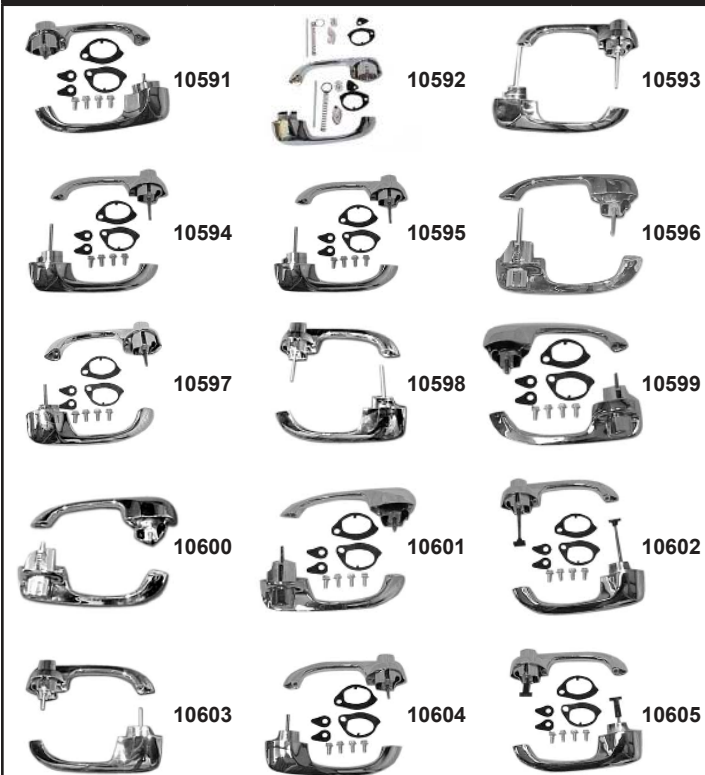

| Part # | Year  | Model  | Part                       | Price       |
|--------|-------|--------|----------------------------|-------------|
| 10591  | 58    | All    | Outside Door Handles       | 145.95 Pair |
| 10592  | 59    | All    | Outside Door Handles       | 119.95 Pair |
| 10593  | 60    | 2-Dr   | Outside Door Handles       | 99.95 Pair  |
| 10594  | 60    | 4-Dr   | Outside Door Handles Front | 99.95 Pair  |
| 10595  | 60    | 4-Dr   | Outside Door Handles Rear  | 99.95 Pair  |
| 10596  | 61-62 | 2/4-Dr | Outside Door Handles       | 99.95 Pair  |
| 10597  | 61-62 | 4-Dr   | Outside Door Handles Rear  | 99.95 Pair  |
| 10598  | 63-64 | 2/4-Dr | Outside Door Handles       | 99.95 Pair  |
| 10599  | 63-64 | 4-Dr   | Outside Door Handles Rear  | 99.95 Pair  |
| 10600  | 65-68 | 2-Dr   | Outside Door Handles       | 99.95 Pair  |
| 10601  | 65-68 | 4-Dr   | Outside Door Handles Front | 109.95 Pair |
| 10602  | 65-68 | 4-Dr   | Outside Door Handles Rear  | 109.95 Pair |
| 10603  | 69-70 | 2-Dr   | Outside Door Handles       | 99.95 Pair  |
| 10604  | 69-70 | 4-Dr   | Outside Door Handles Front | 99.95 Pair  |
| 10605  | 69-70 | 4-Dr   | Outside Door Handles Rear  | 99.95 Pair  |

## DOOR RUBBER J-SEALS



| Part # | Year  | Model | Part               | Price      |
|--------|-------|-------|--------------------|------------|
| 10647  | 58    | All   | Door Rubber J-Seal | 22.95 Pair |
| 10648  | 59-60 | All   | Door Rubber J-Seal | 23.95 Pair |

## DOOR LOCK KNOB FERRULES

| Part # | Year  | Model | Part                    | Price      |
|--------|-------|-------|-------------------------|------------|
| 13194  | 61-64 | All   | Door Lock Knob Ferrules | 8.95 Pair  |
| 16505  | 68-70 | All   | Door Lock Knob Ferrules | 11.95 Pair |

## KEYLESS ENTRY SYSTEMS



Put the modern convenience of remote keyless entry into your classic car!

Keyless entry module with onboard relays for a clean installation, 2 two button remote controls, 2 door lock actuators with 15 lbs. of pull and built in overload protection, 2 rubber doorjamb boots, 2 actuator mounting brackets, 2 actuator connecting rods and clips, wire harness, easy to follow full color step by step instruction manual, and all necessary hardware.

| Part # | Year  | Model | Part  | Price      |
|--------|-------|-------|---|------------|
| 16170  | 61-64 | 2-Dr  | Keyless Entry System                        | 219.95 Kit |
| 16171  | 65-68 | 2-Dr  | Keyless Entry System                        | 219.95 Kit |
| 16172  | 69-70 | 2-Dr  | Keyless Entry System                        | 219.95 Kit |
| 16173  | 61-64 | 2-Dr  | Keyless Entry System w/ Power Trunk Release | 375.95 Kit |
| 16174  | 65-68 | 2-Dr  | Keyless Entry System w/ Power Trunk Release | 375.95 Kit |
| 16175  | 69-70 | 2-Dr  | Keyless Entry System w/ Power Trunk Release | 375.95 Kit |

## DOOR LOCK KNOBS / RETAINERS



| Part # | Year  | Model | Part                   | Price     |
|--------|-------|-------|------------------------|-----------|
| 236    | 58-60 | All   | Lock Knobs Black       | 7.95 Pair |
| 237    | 58-60 | All   | Lock Knobs Red         | 7.95 Pair |
| 238    | 58-60 | All   | Lock Knobs Yellow      | 7.95 Pair |
| 239    | 58-60 | All   | Lock Knobs Blue        | 7.95 Pair |
| 2568   | 58-60 | All   | Lock Knobs Light Blue  | 7.95 Pair |
| 240    | 58-60 | All   | Lock Knobs Turquoise   | 7.95 Pair |
| 241    | 58-60 | All   | Lock Knobs Green       | 7.95 Pair |
| 2569   | 58-60 | All   | Lock Knobs Light Green | 7.95 Pair |
| 242    | 58-60 | All   | Lock Knobs Copper      | 7.95 Pair |
| 2570   | 58-60 | All   | Lock Knobs Gray        | 7.95 Pair |
| 2571   | 58-60 | All   | Lock Knobs Tan         | 7.95 Pair |
| 5258   | 61-67 | All   | Lock Knobs Black       | 5.00 Pair |
| 5259   | 61-67 | All   | Lock Knobs Brown       | 5.00 Pair |
| 5260   | 61-67 | All   | Lock Knobs Blue        | 5.00 Pair |
| 13182  | 61-67 | All   | Lock Knobs Chrome      | 9.95 Pair |
| 5264   | 68-72 | All   | Lock Knobs Black       | 5.00 Pair |
| 5265   | 68-72 | All   | Lock Knobs Brown       | 5.95 Pair |
| 16070  | 69-70 | All   | Door Lock Rod Retainer | 1.50 Ea.  |

# Door Parts

## DOOR LATCH & STRIKER PARTS

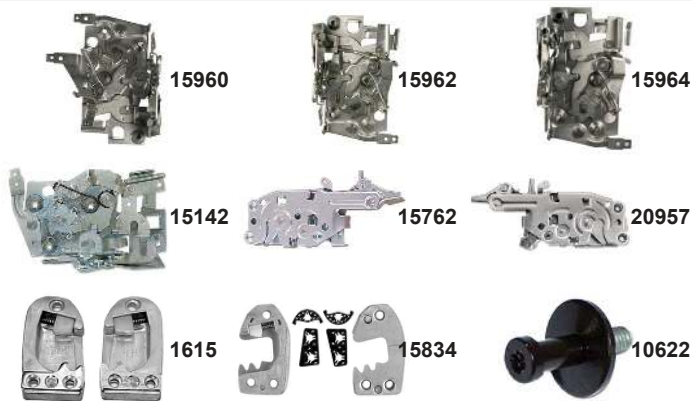

| Part# | Year  | Model                    | Part                           | Price       |
|-------|-------|--------------------------|--------------------------------|-------------|
| 15960 | 58    | Hardtop/Convertible      | Door Latch LH                  | 99.95 Ea.   |
| 15961 | 58    | Hardtop/Convertible      | Door Latch RH                  | 99.95 Ea.   |
| 16278 | 58    | Hardtop/Convertible      | Door Handle To Door Latch Rods | 45.95 Pair  |
| 15962 | 59-60 | Hardtop/Convertible      | Door Latch LH                  | 99.95 Ea.   |
| 15963 | 59-60 | Hardtop/Convertible      | Door Latch RH                  | 99.95 Ea.   |
| 15964 | 61-62 | Hardtop/Convertible      | Door Latch LH                  | 89.95 Ea.   |
| 15965 | 61-62 | Hardtop/Convertible      | Door Latch RH                  | 89.95 Ea.   |
| 15141 | 63    | All                      | Door Latch LH                  | 99.95 Ea.   |
| 15142 | 63    | All                      | Door Latch RH                  | 99.95 Ea.   |
| 15760 | 64    | All                      | Door Latch LH                  | 105.95 Ea.  |
| 15761 | 64    | All                      | Door Latch RH                  | 105.95 Ea.  |
| 15762 | 65-66 | All                      | Door Latch LH                  | 89.95 Ea.   |
| 15763 | 65-66 | All                      | Door Latch RH                  | 89.95 Ea.   |
| 20956 | 68    | 2-Dr                     | Door Latch LH                  | 69.95 Ea.   |
| 20957 | 68    | 2-Dr                     | Door Latch RH                  | 69.95 Ea.   |
| 16503 | 69-70 | 2-Dr Hardtop/Convertible | Door Latch Lh                  | 69.95 Ea.   |
| 16504 | 69-70 | 2-Dr Hardtop/Convertible | Door Latch Rh                  | 69.95 Ea.   |
| 1615  | 58-59 | All                      | Door Striker Plates            | 49.95 Pair  |
| 15834 | 63-64 | All                      | Door Striker Plates            | 109.95 Pair |
| 638   | 58-60 | All                      | Door Striker Plate Screws      | 6.95 Set    |
| 10622 | 70    | All                      | Door Striker Pin               | 7.95 Ea.    |

## MISCELLANEOUS DOOR SEALS

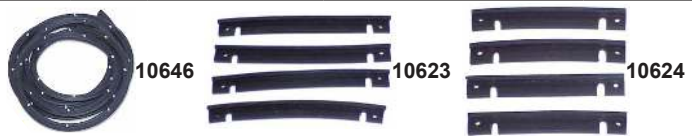

| Part# | Year  | Model          | Part                   | Price     |
|-------|-------|----------------|------------------------|-----------|
| 10646 | 59-60 | Sedan Delivery | Liftgate Door Rubber   | 36.95 Ea. |
| 10623 | 58    | All            | Lower Door Drain Seals | 10.95 Ea. |
| 10624 | 59-64 | All            | Lower Door Drain Seals | 10.95 Ea. |

## DOOR RUBBER



| Part# | Year  | Model                    | Part                      | Price       |
|-------|-------|--------------------------|---------------------------|-------------|
| 10626 | 58    | 2-Dr Hardtop/Convertible | Door Rubber               | 74.95 Pair  |
| 10627 | 59-60 | 2-Dr Hardtop/Convertible | Door Rubber               | 74.95 Pair  |
| 10628 | 61-62 | 2-Dr Hardtop/Convertible | Door Rubber               | 74.95 Pair  |
| 10629 | 63-64 | 2-Dr Hardtop/Convertible | Door Rubber               | 74.95 Pair  |
| 10630 | 65-66 | 2-Dr Hardtop/Convertible | Door Rubber               | 74.95 Pair  |
| 10631 | 67-68 | 2-Dr Hardtop/Convertible | Door Rubber               | 74.95 Pair  |
| 10632 | 69-70 | 2-Dr Hardtop/Convertible | Door Rubber               | 74.95 Pair  |
| 13168 | 59-60 | 4-Dr Hardtop             | Front Door Rubber         | 159.95 Pair |
| 13169 | 59-60 | 4-Dr Hardtop             | Rear Door Rubber          | 159.95 Pair |
| 13170 | 61-62 | 4-Dr Hardtop             | Front Door Rubber         | 169.95 Pair |
| 13171 | 63-64 | 4-Dr Hardtop             | Front Door Rubber         | 169.95 Pair |
| 13172 | 61-64 | 4-Dr Hardtop             | Rear Door Rubber          | 159.95 Pair |
| 13173 | 65-68 | 4-Dr Hardtop             | Front Door Rubber         | 69.95 Pair  |
| 13174 | 65-66 | 4-Dr Hardtop             | Rear Door Rubber          | 109.95 Pair |
| 13175 | 67-68 | 4-Dr Hardtop             | Rear Door Rubber          | 209.95 Pair |
| 10633 | 58    | 2-Dr Sedan/Wagon         | Door Rubber               | 65.95 Pair  |
| 385   | 59-60 | 2-Dr Sedan/Wagon         | Door Rubber               | 65.95 Pair  |
| 10634 | 61-64 | 2-Dr Sedan/Wagon         | Door Rubber               | 69.95 Pair  |
| 10635 | 65-66 | 2-Dr Sedan/Wagon         | Door Rubber               | 69.95 Pair  |
| 10636 | 67-68 | 2-Dr Sedan/Wagon         | Door Rubber               | 69.95 Pair  |
| 13167 | 61-62 | 4-Dr Sedan/Wagon         | Front Door Rubber         | 99.95 Pair  |
| 10637 | 63-64 | 4-Dr Sedan/Wagon         | Front Door Rubber         | 69.95 Pair  |
| 10638 | 61-64 | 4-Dr Sedan               | Rear Door Rubber          | 69.95 Pair  |
| 10639 | 61-64 | 4-Dr Wagon               | Rear Door Rubber          | 99.95 Pair  |
| 10640 | 65-66 | 4-Dr Sedan/Wagon         | Front Door Rubber         | 69.95 Pair  |
| 10641 | 65-66 | 4-Dr Sedan               | Rear Door Rubber          | 69.95 Pair  |
| 10642 | 65-66 | 4-Dr Wagon               | Rear Door Rubber          | 69.95 Pair  |
| 10643 | 67-68 | 4-Dr Sedan               | Front Door Rubber         | 69.95 Pair  |
| 10644 | 67-68 | 4-Dr Sedan               | Rear Door Rubber          | 69.95 Pair  |
| 10645 | 59-60 | El Camino                | Door Rubber               | 69.95 Pair  |
| 16506 | 67-68 | Caprice 2-Dr             | Door Rubber               | 49.95 Pair  |
| 1599  | 58-70 | All                      | 3-M Super Rubber Adhesive | 15.95 Ea.   |

## Door Parts / Emblems

### DOOR BUMPERS



| Part # | Year  | Model        | Part                  | Price     |
|--------|-------|--------------|-----------------------|-----------|
| 1223   | 58    | All          | Door Bumper (1 Prong) | 1.50 Ea.  |
| 355    | 58    | All          | Door Bumper (2 Prong) | 1.00 Ea.  |
| 11674  | 59-60 | 2-Door       | Door Bumpers          | 10.95 Set |
| 13096  | 61-64 | 2-Door       | Door Bumpers          | 9.95 Set  |
| 13098  | 63    | 4-Dr Hardtop | Door Bumpers          | 11.95 Set |
| 13099  | 64    | 4-Dr Sedan   | Door Bumpers          | 11.95 Set |
| 13100  | 64    | 4-Dr Hardtop | Door Bumpers          | 11.95 Set |
| 11675  | 65-66 | 2-Door       | Door Bumpers          | 6.95 Set  |
| 11676  | 67-70 | 2-Door       | Door Bumpers          | 9.95 Set  |

### DOOR PANEL EMBLEMS

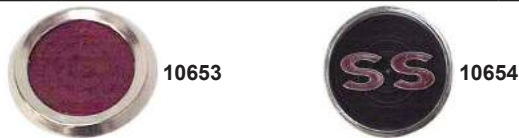

| Part # | Year  | Model     | Part                      | Price      |
|--------|-------|-----------|---------------------------|------------|
| 10653  | 62    | Impala SS | Door Panel Reflector      | 40.95 Ea.  |
| 10653  | 64    | Impala SS | Door Panel Reflector      | 40.95 Ea.  |
| 16058  | 65    | Impala SS | Door Panel Reflector      | 47.95 Ea.  |
| 10654  | 64    | Impala SS | Door Panel Emblems        | 68.95 Pair |
| 15692  | 65    | Impala SS | Door Panel Emblems        | 35.95 Pair |
| 15958  | 66-69 | Impala    | Interior Medallion Chrome | 12.95 Pair |
| 15959  | 66-69 | Impala    | Interior Medallion Black  | 12.95 Pair |

### CONSOLE EMBLEMS



| Part # | Year  | Model     | Part           | Price     |
|--------|-------|-----------|----------------|-----------|
| 10649  | 61-62 | Impala SS | X-Flag Emblem  | 45.95 Ea. |
| 10650  | 63    | Impala SS | Console Emblem | 50.95 Ea. |
| 10651  | 64    | Impala SS | Console Emblem | 42.95 Ea. |
| 10652  | 65    | Impala SS | Console Emblem | 69.95 Ea. |

### TAILGATE EMBLEMS



| Part # | Year | Model           | Part                   | Price     |
|--------|------|-----------------|------------------------|-----------|
| 16047  | 59   | El Camino       | Tailgate Emblem Insert | 75.95 Ea. |
| 10735  | 60   | El Camino w/348 | Tailgate Emblem        | 50.95 Ea. |

### TRUNK EMBLEMS



| Part # | Year | Model          | Part                       | Price      |
|--------|------|----------------|----------------------------|------------|
| 655    | 58   | 6-Cylinder     | Trunk Emblem Insert        | 40.95 Ea.  |
| 877    | 58   | 6-Cylinder     | Trunk Emblem Assembly      | 110.95 Ea. |
| 10730  | 59   | All            | Trunk Emblem               | 65.95 Ea.  |
| 10731  | 60   | 6-Cylinder     | Trunk Emblem Insert        | 32.95 Ea.  |
| 10732  | 60   | 6-Cylinder     | Trunk Emblem Assembly      | 60.95 Ea.  |
| 10733  | 60   | 283            | Trunk Emblem Insert        | 55.95 Ea.  |
| 10734  | 60   | 283            | Trunk Emblem Assembly      | 95.95 Ea.  |
| 10735  | 60   | 348            | Trunk Emblem Assembly      | 50.95 Ea.  |
| 10736  | 61   | 6-Cylinder 283 | Trunk Emblem Insert        | 50.95 Ea.  |
| 10737  | 61   | 6-Cylinder     | Trunk Emblem Assembly      | 89.95 Ea.  |
| 10738  | 61   | 283            | Trunk Emblem Assembly      | 109.95 Ea. |
| 10739  | 61   | 348            | Trunk Emblem Assembly      | 109.95 Ea. |
| 10740  | 61   | Impala SS      | Trunk Emblem Assembly      | 259.95 Ea. |
| 10741  | 62   | Impala         | Trunk Emblem Insert        | 45.95 Ea.  |
| 10742  | 62   | Impala         | Trunk Emblem Assembly      | 99.95 Ea.  |
| 10743  | 62   | Impala SS      | Trunk Emblem Assembly      | 39.95 Ea.  |
| 10744  | 63   | All            | Trunk Emblem Insert        | 45.95 Ea.  |
| 10745  | 63   | All            | Trunk Emblem Assembly      | 99.95 Ea.  |
| 10746  | 64   | All            | Trunk Emblem Insert        | 45.95 Ea.  |
| 10747  | 64   | All            | Trunk Emblem Assembly      | 119.95 Ea. |
| 10748  | 64   | Impala SS      | Trunk Emblem Assembly      | 40.95 Ea.  |
| 10749  | 65   | All            | Trunk Emblem Insert        | 59.95 Ea.  |
| 10750  | 65   | All            | Trunk Emblem Assembly      | 119.95 Ea. |
| 10753  | 66   | All            | Trunk Emblem Insert        | 69.95 Ea.  |
| 10754  | 66   | All            | Trunk Emblem Assembly      | 129.95 Ea. |
| 10755  | 66   | Impala SS      | Trunk Emblem (1-Pc Design) | 99.95 Ea.  |
| 10756  | 66   | Impala SS      | Trunk Emblem (2-Pc Design) | 129.95 Ea. |
| 10759  | 67   | Impala SS      | Trunk Emblem               | 69.95 Ea.  |
| 10761  | 69   | Impala SS      | Trunk Emblem               | 75.95 Ea.  |

# Emblems

## GRILLE EMBLEMS



| Part # | Year | Model         | Part                      | Price      |
|--------|------|---------------|---------------------------|------------|
| 10682  | 60   | 6-Cylinder    | Grille Emblem             | 109.95 Ea. |
| 10683  | 60   | 283           | Grille Emblem             | 109.95 Ea. |
| 10684  | 60   | 348           | Grille Emblem             | 99.95 Ea.  |
| 10685  | 61   | 6-Cylinder    | Grille Emblem             | 139.95 Ea. |
| 10686  | 61   | 283           | Grille Emblem             | 109.95 Ea. |
| 10687  | 61   | 348           | Grille Emblem             | 109.95 Ea. |
| 10688  | 64   | All           | Chevrolet Grille Emblem   | 39.95 Ea.  |
| 10689  | 65   | Impala SS     | Grille Emblem             | 65.95 Ea.  |
| 10690  | 65   | All           | Chevrolet Grille Emblem   | 49.95 Ea.  |
| 10691  | 66   | Impala        | Grille Emblem             | 65.95 Ea.  |
| 10692  | 66   | Impala SS     | Grille Emblem             | 69.95 Ea.  |
| 10693  | 67   | Impala SS     | Grille Emblem             | 99.95 Ea.  |
| 10694  | 67   | Impala SS 427 | Grille Emblem             | 109.95 Ea. |
| 10695  | 68   | All w/o 427   | Blue Bowtie Grille Emblem | 38.95 Ea.  |
| 10696  | 68   | All w/427     | Red Bowtie Grille Emblem  | 38.95 Ea.  |
| 10697  | 68   | Impala SS     | Grille Emblem             | 129.95 Ea. |
| 10698  | 68   | Impala SS 427 | Grille Emblem             | 119.95 Ea. |
| 12715  | 69   | Impala SS     | Grille Emblem             | 89.95 Ea.  |

## REAR BODY EMBLEMS



| Part # | Year | Model     | Part                      | Price      |
|--------|------|-----------|---------------------------|------------|
| 10751  | 65   | Impala SS | Chevrolet Emblem          | 65.95 Ea.  |
| 10752  | 65   | Impala SS | Rear Body Emblem          | 49.95 Ea.  |
| 10757  | 66   | Caprice   | Rear Body Emblem          | 75.95 Ea.  |
| 12877  | 67   | All       | Rear Body Emblem Assembly | 129.95 Ea. |
| 10758  | 67   | All       | Rear Body Emblem Insert   | 70.95 Ea.  |
| 10760  | 68   | Impala SS | Rear Body Emblem          | 89.95 Ea.  |

## HORN BUTTON EMBLEMS



| Part # | Year  | Model     | Part                    | Price     |
|--------|-------|-----------|-------------------------|-----------|
| 10708  | 58-60 | Impala    | Horn Ring Emblem        | 35.95 Ea. |
| 10709  | 62-63 | Impala    | Horn Ring Emblem        | 19.95 Ea. |
| 10709  | 62    | Impala SS | Horn Ring Emblem        | 19.95 Ea. |
| 10710  | 63    | Impala SS | Horn Ring Emblem        | 19.95 Ea. |
| 10711  | 64    | Impala    | Horn Ring Emblem        | 35.95 Ea. |
| 10712  | 67    | Impala SS | Horn Ring Emblem        | 44.95 Ea. |
| 10713  | 67    | All       | Horn Ring Bowtie Emblem | 44.95 Ea. |
| 10714  | 69    | Impala SS | Horn Pad Emblem         | 11.95 Ea. |

## QUARTER PANEL EMBLEMS



| Part # | Year | Model     | Part                     | Price       |
|--------|------|-----------|--------------------------|-------------|
| 10716  | 58   | Impala    | Quarter Flag Emblem      | 45.95 Pair  |
| 10717  | 59   | Impala    | Quarter X-Flag Emblem    | 109.95 Pair |
| 10718  | 60   | Impala    | Quarter X-Flag Emblem    | 109.95 Pair |
| 10719  | 61   | Impala    | Quarter Flag Emblem      | 40.95 Pair  |
| 10720  | 61   | Impala SS | Quarter Emblem           | 269.95 Pair |
| 10721  | 62   | Belair    | Quarter Emblem           | 109.95 Pair |
| 10722  | 62   | Impala    | Quarter Emblem           | 29.95 Pair  |
| 10723  | 62   | Impala SS | Quarter Emblem           | 45.95 Pair  |
| 10724  | 63   | Impala    | Quarter Emblem           | 39.95 Pair  |
| 10725  | 63   | Impala SS | Quarter Emblem           | 45.95 Pair  |
| 10726  | 64   | Impala    | Quarter Emblem           | 29.95 Pair  |
| 10727  | 64   | Impala SS | Quarter Emblem           | 45.95 Pair  |
| 10729  | 67   | Impala    | Quarter Emblem           | 65.95 Pair  |
| 10715  | 69   | All       | Astro Ventilation Emblem | 13.95 Ea.   |

## DASH EMBLEMS



| Part # | Year | Model  | Part        | Price     |
|--------|------|--------|-------------|-----------|
| 15227  | 62   | Impala | Dash Emblem | 62.95 Ea. |

# Emblems

## FENDER EMBLEMS

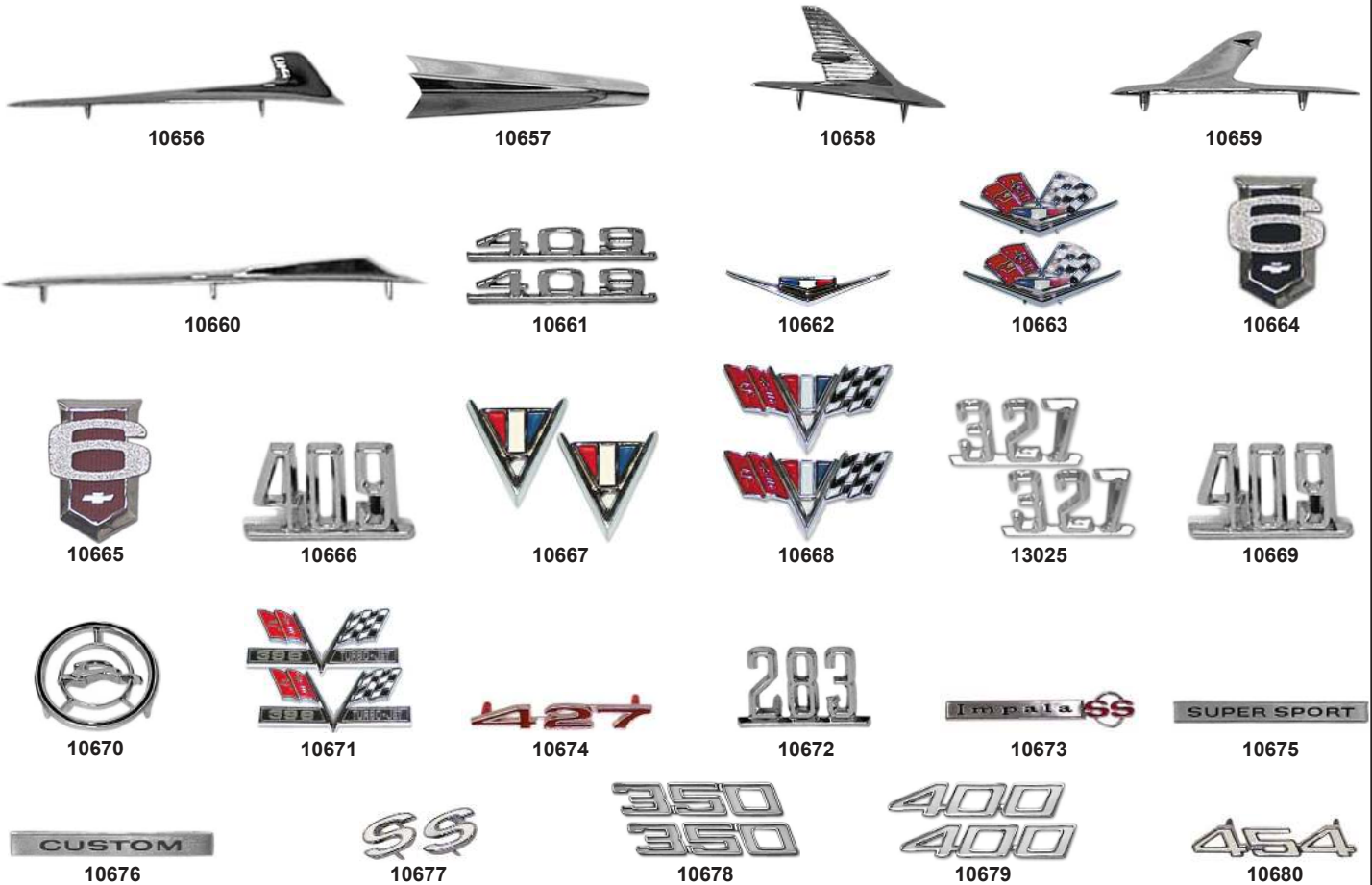

| Part # | Year  | Model      | Part                        | Price       |
|--------|-------|------------|-----------------------------|-------------|
| 10655  | 58    | All        | Front Fender Louvers        | 69.95 Set   |
| 10656  | 58    | All        | Fender Ornaments            | 109.95 Pair |
| 10657  | 59    | All        | Fender Ornaments            | 109.95 Pair |
| 10658  | 60    | All        | Fender Ornaments            | 109.95 Pair |
| 10659  | 61    | All        | Fender Ornaments            | 109.95 Pair |
| 10660  | 62    | All        | Fender Ornaments            | 89.95 Pair  |
| 10661  | 62-63 | 409        | Front Fender Emblem         | 35.95 Pair  |
| 10662  | 62-63 | 283        | Front Fender V-Emblem       | 55.95 Pair  |
| 10663  | 62-63 | 327/409    | Front Fender X-Flag         | 34.95 Pair  |
| 10664  | 63    | 6-Cylinder | Front Fender Emblem (Black) | 69.95 Pair  |
| 10665  | 63    | 6-Cylinder | Front Fender Emblem (Red)   | 69.95 Pair  |
| 10666  | 64    | 409        | 409 Emblems                 | 35.95 Pair  |
| 10667  | 64    | 283        | Front Fender V-Emblem       | 39.95 Pair  |

| Part # | Year  | Model         | Part                  | Price       |
|--------|-------|---------------|-----------------------|-------------|
| 10668  | 64    | 327/409       | Front Fender V-Emblem | 23.95 Pair  |
| 13025  | 65    | 327           | 327 Emblems           | 18.95 Pair  |
| 10669  | 65    | 409           | Front Fender Emblem   | 35.95 Pair  |
| 10670  | 65-66 | Impala        | Front Fender Emblem   | 49.95 Pair  |
| 10668  | 65-67 | 283/327       | Front Fender V-Emblem | 23.95 Pair  |
| 10672  | 65    | 283           | 283 Emblems           | 25.95 Pair  |
| 10671  | 65-67 | 396           | Front Fender Emblem   | 35.95 Pair  |
| 10673  | 67    | Impala SS     | Front Fender Emblem   | 135.95 Pair |
| 10674  | 67    | 427 Impala SS | Front Fender Emblem   | 85.95 Pair  |
| 10675  | 68    | SS            | Front Fender Emblem   | 75.95 Pair  |
| 10676  | 68    | Custom        | Front Fender Emblem   | 75.95 Pair  |
| 10677  | 69    | SS w/427      | Front Fender Emblem   | 29.95 Pair  |
| 10678  | 69-70 | 350           | Front Fender Emblem   | 75.95 Pair  |
| 10679  | 70-72 | 400           | Front Fender Emblem   | 75.95 Pair  |
| 10680  | 70-74 | 454           | Front Fender Emblem   | 75.95 Pair  |

## GLOVE BOX EMBLEMS

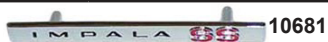

| Part # | Year | Model     | Part                  | Price     |
|--------|------|-----------|-----------------------|-----------|
| 16268  | 65   | Impala    | Glove Box Door Emblem | 60.95 Ea. |
| 10681  | 66   | Impala SS | Glove Box Emblem      | 70.95 Ea. |

## TRUNK VEES



| Part # | Year | Model  | Part      | Price      |
|--------|------|--------|-----------|------------|
| 15745  | 58   | All V8 | Trunk Vee | 75.95 Ea.  |
| 10763  | 60   | All V8 | Trunk Vee | 105.95 Ea. |

# Emblems

## ROOF PANEL EMBLEMS



| Part # | Year  | Model   | Part              | Price      |
|--------|-------|---------|-------------------|------------|
| 10728  | 65-66 | Caprice | Roof Panel Emblem | 89.95 Pair |

## HOOD LETTERS & SCRIPTS



13394



11699



11700



11701

| Part # | Year  | Model           | Part         | Price     |
|--------|-------|-----------------|--------------|-----------|
| 13394  | 59    | All             | Hood Script  | 59.95 Ea. |
| 11699  | 60-61 | All             | Hood Letters | 55.95 Set |
| 11700  | 69    | Impala          | Hood Letters | 79.95 Set |
| 11701  | 69    | Belair/Biscayne | Hood Script  | 59.95 Ea. |

## DASH SCRIPTS



11698



12934

| Part # | Year | Model  | Part                        | Price     |
|--------|------|--------|-----------------------------|-----------|
| 11698  | 58   | Impala | Dash or Rear Speaker Script | 65.95 Ea. |
| 12934  | 58   | All    | Positraction Dash Script    | 79.95 Ea. |

## QUARTER LETTERS & SCRIPTS



11709



11710



11711



11713



11714



11716

| Part # | Year | Model  | Part   | Price      |
|--------|------|--------|--|------------|
| 11709  | 58   | Impala | Quarter Scripts                              | 65.95 Pair |
| 11710  | 59   | Impala | Quarter Letters<br>(2 Sets Required Per Car) | 64.95 Set  |
| 11711  | 60   | Impala | Quarter Scripts                              | 89.95 Pair |
| 11712  | 61   | Impala | Quarter Scripts                              | 45.95 Pair |
| 11713  | 62   | Impala | Quarter Scripts                              | 45.95 Pair |
| 11714  | 63   | Impala | Quarter Letters<br>(2 Sets Required Per Car) | 45.95 Set  |
| 11715  | 64   | Impala | Quarter Letters<br>(2 Sets Required Per Car) | 59.95 Set  |
| 11716  | 67   | Impala | Quarter Scripts                              | 99.95 Pair |

## HOOD EMBLEMS



822



10699



154



156



10700



15450



10701



10702



10703



10704



10705



10707

| Part # | Year | Model      | Part                 | Price      |
|--------|------|------------|----------------------|------------|
| 15744  | 58   | Impala     | Hood Vee Emblem      | 69.95 Ea.  |
| 822    | 58   | 6-Cylinder | Hood Emblem Insert   | 49.95 Ea.  |
| 10699  | 58   | 6-Cylinder | Hood Emblem Assembly | 149.95 Ea. |
| 154    | 58   | V8         | Hood Emblem Insert   | 32.95 Ea.  |
| 156    | 58   | V8         | Hood Emblem Assembly | 60.95 Ea.  |
| 10700  | 59   | 348        | Hood Emblem          | 119.95 Ea. |
| 15450  | 59   | V8         | Hood Vee Emblem      | 59.95 Ea.  |
| 10701  | 62   | All        | Hood Emblem Insert   | 45.95 Ea.  |
| 10702  | 62   | All        | Hood Emblem Assembly | 95.95 Ea.  |
| 10703  | 63   | All        | Hood Emblem Insert   | 45.95 Ea.  |
| 10704  | 63   | All        | Hood Emblem Assembly | 95.95 Ea.  |
| 10705  | 64   | All        | Hood Emblem Insert   | 45.95 Ea.  |
| 10706  | 65   | Impala     | Hood Emblem Insert   | 45.95 Ea.  |
| 10707  | 65   | Impala     | Hood Emblem Assembly | 99.95 Ea.  |

## FENDER LETTERS & SCRIPTS



11702



11704



11705



11706



11707



11708

| Part # | Year  | Model     | Part  | Price       |
|--------|-------|-----------|---|-------------|
| 11702  | 59    | El Camino | Fender Scripts                              | 129.95 Pair |
| 11704  | 65-66 | Impala    | Fender Letters<br>(2 Sets Required Per Car) | 24.95 Set   |
| 11705  | 65-66 | Impala SS | Fender Scripts                              | 69.95 Pair  |
| 11706  | 65-67 | Caprice   | Fender Scripts                              | 109.95 Pair |
| 11707  | 68    | Impala    | Fender Scripts                              | 68.95 Set   |
| 11708  | 69    | Impala    | Fender Scripts                              | 105.95 Set  |

# Emblems / Exhaust / Fender Parts

## TRUNK LETTERS & SCRIPTS



11717



11718



11719



11720



11721



11722

| Part# | Year | Model             | Part                  | Price     |
|-------|------|-------------------|-----------------------|-----------|
| 11717 | 58   | Impala            | Trunk Script          | 28.95 Ea. |
| 16276 | 62   | Bel Air/ Biscayne | Trunk Script          | 50.95 Ea. |
| 11718 | 64   | Impala            | Trunk Letters         | 35.95 Set |
| 11719 | 66   | All               | Trunk/Tailgate Script | 83.95 Ea. |
| 11720 | 67   | All               | Rear Body Script      | 75.95 Ea. |
| 11721 | 68   | All               | Trunk Script          | 83.95 Ea. |
| 11722 | 69   | All               | Trunk Script          | 62.95 Ea. |

## ENGINE PULLEYS



10764



10767



10769



10770

| Part# | Year  | Model                   | Part   | Price      |
|-------|-------|-------------------------|--|------------|
| 10764 | 66-68 | V8 Small Block          | Crank Shaft Pulley Dual Groove (6 5/8" Diameter) | 89.95 Ea.  |
| 10765 | 65-68 | V8 Small Block w/PS     | Crank Shaft Pulley                               | 69.95 Ea.  |
| 10767 | 67    | 396 w/A.i.r. and w/o AC | Crank Shaft Pulley                               | 159.95 Ea. |
| 10769 | 65-68 | 396/427 Hp              | Water Pump Pulley                                | 119.95 Ea. |
| 10770 | 69    | 6-Cylinder w/o AC       | Water Pump Pulley                                | 65.95 Ea.  |

## EXHAUST HANGERS & MISC. EXHAUST PARTS



12957



12961



12964

| Part# | Year  | Model | Part                             | Price      |
|-------|-------|-------|----------------------------------|------------|
| 12957 | 58-60 | All   | Muffler Hanger LH                | 22.95 Ea.  |
| 12958 | 58-60 | All   | Muffler Hanger RH                | 22.95 Ea.  |
| 12959 | 58-60 | All   | Front Exhaust Hanger LH          | 22.95 Ea.  |
| 12960 | 58-60 | All   | Front Exhaust Hanger RH          | 22.95 Ea.  |
| 12961 | 58-60 | All   | Rear Exhaust Hanger LH           | 22.95 Ea.  |
| 12962 | 58-60 | All   | Rear Exhaust Hanger RH           | 22.95 Ea.  |
| 12963 | 58-60 | All   | Rear Exhaust Frame Bracket LH/RH | 20.95 Ea.  |
| 12964 | 58-60 | All   | Exhaust Ports                    | 99.95 Pair |

## FLY WHEEL PARTS



3597



3598



15185

| Part# | Year  | Model         | Part                      | Price     |
|-------|-------|---------------|---------------------------|-----------|
| 3597  | 58-63 | V8            | Lower Fly Wheel Cover     | 65.95 Ea. |
| 3598  | 58-62 | V8 except 409 | Fly Wheel Cover Extension | 21.95 Ea. |
| 15185 | 61-63 | 409           | Fly Wheel Cover Extension | 24.95 Ea. |

## FENDER SEALS



11007



418



11009

11010

| Part# | Year  | Model | Part                     | Price      |
|-------|-------|-------|--------------------------|------------|
| 11007 | 58    | All   | Fender Anti-Squeak Seals | 23.95 Set  |
| 418   | 58-60 | All   | Inner Fender Seals       | 19.95 Pair |
| 11009 | 61    | All   | Inner Fender Seals       | 12.95 Pair |
| 11010 | 62    | All   | Inner Fender Seals       | 20.95 Pair |

## QUARTER PANEL SEALS



11011



11012



11013

| Part# | Year | Model | Part                                 | Price     |
|-------|------|-------|--------------------------------------|-----------|
| 11011 | 65   | All   | Quarter Panel Extension To Body Seal | 11.95 Set |
| 11012 | 67   | All   | Quarter Panel Extension To Body Seal | 15.95 Set |
| 11013 | 68   | All   | Quarter Panel Extension Seal         | 8.95 Set  |

## FENDER SKIRT SEALS



| Part# | Year  | Model | Part                      | Price      |
|-------|-------|-------|---------------------------|------------|
| 388   | 58-64 | All   | Fender Skirt To Body Seal | 16.95 Pair |

## FENDER SKIRT HARDWARE



| Part# | Year  | Model | Part                  | Price    |
|-------|-------|-------|-----------------------|----------|
| 234   | 58-64 | All   | Fender Skirt Hardware | 9.95 Set |

## EXHAUST PORT TRIM



| Part# | Year  | Model | Part          | Price      |
|-------|-------|-------|---------------|------------|
| 12964 | 58-60 | All   | Exhaust Ports | 99.95 Pair |

# Fender Parts / Firewall Pads / Floor Mats / Floor Shifters

## FENDER SKIRT SCUFF PADS



| Part # | Year  | Model | Part                    | Price      |
|--------|-------|-------|-------------------------|------------|
| 11014  | 58    | All   | Fender Skirt Scuff Pads | 22.95 Pair |
| 11015  | 59    | All   | Fender Skirt Scuff Pads | 22.95 Pair |
| 11016  | 60    | All   | Fender Skirt Scuff Pads | 22.95 Pair |
| 11017  | 61    | All   | Fender Skirt Scuff Pads | 22.95 Pair |
| 11018  | 62    | All   | Fender Skirt Scuff Pads | 22.95 Pair |
| 11019  | 63    | All   | Fender Skirt Scuff Pads | 22.95 Pair |
| 11020  | 64    | All   | Fender Skirt Scuff Pads | 22.95 Pair |
| 11021  | 65-66 | All   | Fender Skirt Scuff Pads | 22.95 Pair |

## SPLASH PAN SEALS



| Part # | Year | Model | Part                          | Price     |
|--------|------|-------|-------------------------------|-----------|
| 11008  | 58   | All   | Front Splash Pan Seals        | 11.95 Set |
| 11355  | 58   | All   | Front Splash Pan Dust Shields | 11.95 Set |
| 11356  | 62   | All   | Rear Body Dust Shields        | 11.95 Set |

## FIREWALL PADS



| Part #  | Year  | Model  | Part                   | Price     |
|---------|-------|--------|------------------------|-----------|
| 11030 ② | 58    | All    | Firewall Pad           | 52.95 Ea. |
| 11031 ② | 59-60 | All    | Firewall Pad           | 52.95 Ea. |
| 11032 ② | 61-62 | w/o AC | Firewall Pad           | 52.95 Ea. |
| 11033 ② | 63-64 | All    | Firewall Pad           | 52.95 Ea. |
| 11034   | 65-66 | w/AC   | Firewall Pad           | 52.95 Ea. |
| 11035   | 65-66 | w/o AC | Firewall Pad           | 52.95 Ea. |
| 274     | 58-66 | All    | Firewall Pad Fasteners | 8.95 Set  |

② = add \$16.95 handling per item

## FLOOR MATS



These mats are made of high-grade rubber and are correct reproductions of the originals. They feature the correct emblems and markings. One set includes 2 front and 2 rear mats.

| Part # | Year  | Model | Part                    | Price      |
|--------|-------|-------|-------------------------|------------|
| 929    | 58    | All   | Black (Replacement)     | 89.95 Set  |
| 930    | 58    | All   | Red (Replacement)       | 89.95 Set  |
| 931    | 58    | All   | Blue (Replacement)      | 89.95 Set  |
| 933    | 58    | All   | Turquoise (Replacement) | 89.95 Set  |
| 2270   | 58    | All   | Gray (Replacement)      | 89.95 Set  |
| 3555   | 58    | All   | Tan (Replacement)       | 89.95 Set  |
| 13021  | 59-60 | All   | Red                     | 189.95 Set |
| 13022  | 59-60 | All   | Black                   | 189.95 Set |
| 13023  | 59-60 | All   | Blue                    | 189.95 Set |
| 13024  | 59-60 | All   | Gray                    | 189.95 Set |
| 13130  | 59-60 | All   | Tan                     | 189.95 Set |
| 13131  | 61-64 | All   | White                   | 189.95 Set |
| 13132  | 61-64 | All   | Black                   | 189.95 Set |
| 13133  | 61-64 | All   | Blue                    | 189.95 Set |
| 13134  | 61-64 | All   | Tan                     | 189.95 Set |
| 13135  | 61-62 | All   | Red                     | 189.95 Set |
| 13136  | 63-64 | All   | Red                     | 189.95 Set |
| 15452  | 65-70 | All   | Black                   | 159.95 Set |
| 15453  | 65-70 | All   | Red                     | 159.95 Set |
| 15454  | 65-70 | All   | Light Blue              | 159.95 Set |
| 15455  | 65-70 | All   | Medium Blue             | 159.95 Set |
| 15456  | 65-70 | All   | Dark Blue               | 159.95 Set |
| 15457  | 65-70 | All   | Fawn                    | 159.95 Set |
| 15458  | 65-70 | All   | Dark Green              | 159.95 Set |

## FLOOR SHIFTER PARTS



| Part # | Year  | Model            | Part                                    | Price     |
|--------|-------|------------------|---|-----------|
| 11057  | 64-67 | Impala Automatic | Console Slider                          | 6.95 Ea.  |
| 11058  | 63    | All              | Shifter Lever Floor Mount Selector Seal | 45.95 Ea. |
| 13017  | 63-67 | All              | Transmission Shifter Adapter Bracket    | 29.95 Ea. |

# Floor Shifters / Fuel System

## FLOOR SHIFTER BOOTS



11050



11051



11052



11053



11055



11056

| Part# | Year  | Model                | Part                         | Price     |
|-------|-------|----------------------|------------------------------|-----------|
| 11050 | 58-59 | 4-Speed              | Shifter Boot                 | 39.95 Ea. |
| 11051 | 60-64 | 4-Speed              | Shifter Boot (Bench Seat)    | 29.95 Ea. |
| 11052 | 61    | Impala SS 4-Speed    | Shifter Boot                 | 95.95 Ea. |
| 11053 | 62    | Impala SS 4-Speed    | Shifter Boot (Console)       | 43.95 Ea. |
| 11054 | 63    | Impala SS 4-Speed    | Shifter Boot                 | 65.95 Ea. |
| 15257 | 63    | SS Auto-matic        | Shifter Boot                 | 24.95 Ea. |
| 11055 | 64    | Impala SS            | Upper Shifter Boot (Console) | 35.95 Ea. |
| 11056 | 64    | Impala SS            | Lower Shifter Boot (Console) | 45.95 Ea. |
| 16273 | 66-67 | SS Manual w/ Console | Shifter Boot                 | 55.95 Ea. |

## FLOOR SHIFTER KNOBS



11059



11060



11061



15812



15813

| Part# | Year  | Model      | Part                               | Price     |
|-------|-------|------------|------------------------------------|-----------|
| 11059 | 64-67 | Automatic  | Floor Shifter Lever Release Button | 17.95 Ea. |
| 11060 | 58-63 | 4-Speed    | Shift Knob                         | 10.95 Ea. |
| 11061 | 63    | Powerglide | Shift Knob                         | 8.95 Ea.  |
| 15812 | 64-67 | 4-Spd      | Chrome Shift Ball                  | 35.95 Ea. |
| 15813 | 64-67 | 4-Spd      | White Shift Ball                   | 35.95 Ea. |

## GAS TANK FILLER NECK GROMMETS



11135



11136

| Part# | Year  | Model | Part                | Price     |
|-------|-------|-------|---------------------|-----------|
| 11135 | 61-63 | All   | Filler Neck Grommet | 15.95 Ea. |
| 11136 | 64    | All   | Filler Neck Grommet | 5.95 Ea.  |

## GAS LINES PUMP TO CARBURETOR



11069



11070



11074



11075

| Part# | Year  | Model                                | Part             | Price     |
|-------|-------|--------------------------------------|------------------|-----------|
| 11066 | 59-64 | 283 2-Barrel                         | Gas Line To Pump | 18.95 Ea. |
| 11067 | 62-64 | 283 4-Barrel                         | Gas Line To Pump | 18.95 Ea. |
| 11067 | 62-64 | 327 250 Hp                           | Gas Line To Pump | 18.95 Ea. |
| 11068 | 62-64 | 327 300 Hp                           | Gas Line To Pump | 18.95 Ea. |
| 11069 | 58    | 348 3X2-Barrel W/ Vacuum Assist Pump | Gas Line To Pump | 70.95 Ea. |
| 11070 | 58    | 348 4-Barrel W/ Vacuum Assist Pump   | Gas Line To Pump | 50.95 Ea. |
| 11071 | 58-61 | 348 4-Barrel                         | Gas Line To Pump | 18.95 Ea. |
| 11072 | 59-61 | 348 3X2-Barrel                       | Gas Line To Pump | 58.95 Ea. |
| 11073 | 62    | 409 2X4-Barrel                       | Gas Line To Pump | 79.95 Ea. |
| 11074 | 63-64 | 409 2X4-Barrel                       | Gas Line To Pump | 85.95 Ea. |
| 11075 | 63-64 | 409 4-Barrel                         | Gas Line To Pump | 69.95 Ea. |
| 11076 | 69    | 427                                  | Gas Line To Pump | 35.95 Ea. |

## GAS LINES ALONG FRAME



11077



11079



11081



11082



11083



11085

| Part#              | Year  | Model       | Part                    | Price     |
|--------------------|-------|-------------|-------------------------|-----------|
| 11077 <sup>e</sup> | 58-64 | 6-Cylinder  | Long Gas Line           | 69.95 Ea. |
| 11078 <sup>e</sup> | 58    | 283/348     | Long Gas Line           | 69.95 Ea. |
| 11079 <sup>e</sup> | 59-61 | 283/348     | Long Gas Line           | 69.95 Ea. |
| 11080 <sup>e</sup> | 62-64 | 327/409     | Long Gas Line           | 69.95 Ea. |
| 11081 <sup>e</sup> | 63-64 | 409         | Return Gas Line Only    | 69.95 Ea. |
| 11082 <sup>e</sup> | 65-66 | Small Bkck  | Long Gas Line Set       | 75.95 Set |
| 11083 <sup>e</sup> | 65-66 | Big Bkck    | Long Gas Line Set       | 75.95 Set |
| 11084 <sup>e</sup> | 67-68 | Small Bkck  | Long Gas Line Set       | 75.95 Set |
| 11085 <sup>e</sup> | 67-68 | Big Bkck    | Long Gas Line Set       | 75.95 Set |
| 11086 <sup>e</sup> | 69    | Small Bkck  | Long Gas Line Set       | 75.95 Set |
| 11087 <sup>e</sup> | 69    | Big Bkck    | Long Gas Line Set       | 75.95 Set |
| 11088 <sup>e</sup> | 65-69 | Hardtop     | Fuel Tank Vent Line Set | 25.95 Set |
| 11089 <sup>e</sup> | 65-69 | Convertible | Fuel Tank Vent Line Set | 25.95 Set |
| 11091              | 58    | All         | Gas Line Clip Set       | 19.95 Set |
| 11092              | 59-64 | All         | Gas Line Clip Set       | 12.95 Set |

<sup>e</sup> = add \$16.95 handling per item

# Fuel System

## GAS DOORS AND GUARDS



11062      11063      11064      13186

| Part # | Year  | Model     | Part           | Price     |
|--------|-------|-----------|----------------|-----------|
| 11062  | 61    | Impala    | Gas Door Guard | 16.95 Ea. |
| 11063  | 62-63 | Impala    | Gas Door Guard | 23.95 Ea. |
| 11064  | 64    | Impala    | Gas Door Guard | 16.95 Ea. |
| 11065  | 64    | Impala SS | Gas Door Guard | 14.95 Ea. |
| 13186  | 64    | All       | Gas Door       | 65.95 Ea. |

## FILLER NECKS & HOSES



11090

15680

| Part # | Year  | Model     | Part                      | Price     |
|--------|-------|-----------|---------------------------|-----------|
| 11090  | 61-64 | All       | Gas Tank Filler Neck Hose | 20.95 Ea. |
| 15943  | 69-70 | All       | Gas Tank Filler Neck Hose | 12.95 Ea. |
| 15680  | 61-63 | Non-Wagon | Gas Tank Filler Neck      | 38.95 Ea. |
| 15681  | 64    | Non-Wagon | Gas Tank Filler Neck      | 38.95 Ea. |

## GAS TANKS



11105

11106

11107

11108

| Part #  | Year  | Model                     | Part     | Price      |
|---------|-------|---------------------------|----------|------------|
| 11105 ③ | 58    | Hardtop/Sedan/Convertible | Gas Tank | 199.95 Ea. |
| 11106 ③ | 59-60 | Hardtop/Sedan/Convertible | Gas Tank | 199.95 Ea. |
| 11107 ② | 61-64 | Hardtop/Sedan/Convertible | Gas Tank | 149.95 Ea. |
| 11108 ③ | 65-66 | Hardtop/Sedan/Convertible | Gas Tank | 189.95 Ea. |
| 15797 ③ | 67    | Hardtop/Sedan/Convertible | Gas Tank | 189.95 Ea. |
| 15798 ③ | 68    | Hardtop/Sedan/Convertible | Gas Tank | 189.95 Ea. |
| 15799 ③ | 69-70 | Hardtop/Sedan/Convertible | Gas Tank | 189.95 Ea. |

## EFI GAS TANKS



16546

16546

16533

16555

1958-70 Chevy Passenger Car EFI Fuel Tanks. Will fit Hardtop, Sedans, and Convertibles. Fuel Injection ready, some units include 2 piece neck design for easier shipping. Utilizes tanks brand GPA series fuel pumps. Uses aftermarket 5 bolt senders. Internal baffling with extra large 4.8 liter dual tube fuel tray to prevent fuel pump starvations. Perfect for Pro-touring, Autocross, or Road racing applications. Looks like OE tank when installed. Coated galvanized steel then powder coated silver. 1" deeper than stock, longer straps included with tank.,

| Part #  | Year  | Model                     | Part                            | Price      |
|---------|-------|---------------------------|---------------------------------|------------|
| 16546★② | 58    | Hardtop/Sedan/Convertible | Gas Tank For EFI                | 279.95 Ea. |
| 16547★② | 58    | Hardtop/Sedan/Convertible | Gas Tank EFI Kit (Up to 630 HP) | 535.95 Kit |
| 16548★② | 58    | Hardtop/Sedan/Convertible | Gas Tank EFI Kit (Up to 900 HP) | 535.95 Kit |
| 16549★② | 59-60 | Hardtop/Sedan/Convertible | Gas Tank For EFI                | 279.95 Ea. |
| 16550★② | 59-60 | Hardtop/Sedan/Convertible | Gas Tank EFI Kit (Up to 630 HP) | 535.95 Kit |
| 16551★② | 59-60 | Hardtop/Sedan/Convertible | Gas Tank EFI Kit (Up to 900 HP) | 535.95 Kit |
| 16552★② | 61-64 | Hardtop/Sedan/Convertible | Gas Tank For EFI                | 235.95 Ea. |
| 16553★② | 61-64 | Hardtop/Sedan/Convertible | Gas Tank EFI Kit (Up to 630 HP) | 519.95 Kit |
| 16554★② | 61-64 | Hardtop/Sedan/Convertible | Gas Tank EFI Kit (Up to 900 HP) | 519.95 Kit |
| 16555★② | 65-66 | Hardtop/Sedan/Convertible | Gas Tank For EFI                | 265.95 Ea. |
| 16556★② | 65-66 | Hardtop/Sedan/Convertible | Gas Tank EFI Kit (Up to 630 HP) | 509.95 Kit |
| 16557★② | 65-66 | Hardtop/Sedan/Convertible | Gas Tank EFI Kit (Up to 900 HP) | 509.95 Kit |

★ = special order non-stocking item, please allow 4-6 weeks for delivery.

② = add \$16.95 handling per item

③ = add \$80.95 handling per item

# Fuel System

## FUEL LINK



The Fuel Link interface is the problem-solver between fuel senders and gauges to correct ohm mismatch and erratic movement due to fuel slosh.

| Part # | Year  | Model | Part      | Price      |
|--------|-------|-------|-----------|------------|
| 4392   | 58-70 | All   | Fuel Link | 139.95 Ea. |

## GAS TANK STRAPS



| Part # | Year  | Model                         | Part                       | Price      |
|--------|-------|-------------------------------|----------------------------|------------|
| 15559  | 58    | Non-Wagon                     | Gas Tank Straps            | 75.95 Pair |
| 15560  | 58    | Wagon                         | Gas Tank Straps            | 75.95 Pair |
| 15945  | 59-60 | Non-Wagon                     | Gas Tank Straps            | 26.95 Set  |
| 11103  | 61-64 | Hardtop/Sedan/<br>Convertible | Gas Tank Straps            | 22.95 Pair |
| 11104  | 65-66 | Hardtop/Sedan/<br>Convertible | Gas Tank Straps            | 22.95 Pair |
| 15946  | 67    | Non-Wagon                     | Gas Tank Straps            | 29.95 Set  |
| 15947  | 68-70 | Non-Wagon                     | Gas Tank Straps            | 29.95 Set  |
| 15948  | 58-70 | All                           | Gas Tank Strap<br>Hardware | 5.00 Set   |

## GAS TANK SENDING UNIT PARTS



| Part # | Year  | Model | Part                            | Price     |
|--------|-------|-------|---------------------------------|-----------|
| 5351   | 58-64 | All   | Sending Unit Float              | 8.95 Ea.  |
| 1201   | 58-70 | All   | Sending Unit (5/16 Line) Filter | 10.95 Ea. |
| 1843   | 58-70 | All   | Sending Unit (3/8 Line) Filter  | 10.95 Ea. |
| 16143  | 67-70 | All   | Sending Unit Gasket             | 2.50 Ea.  |

## GAS TANK SENDING UNIT RINGS



| Part # | Year  | Model | Part                         | Price    |
|--------|-------|-------|------------------------------|----------|
| 13070  | 61-66 | All   | Sending Unit Lock Ring       | 2.00 Ea. |
| 6838   | 61-67 | All   | Gas Tank Sending Unit O-Ring | 1.50 Ea. |

## GAS TANK SENDING UNITS



| Part # | Year  | Model                         | Part                         | Price     |
|--------|-------|-------------------------------|------------------------------|-----------|
| 11093  | 58-60 | Hardtop/Sedan/<br>Convertible | 6-Cylinder/283 2-Barrel      | 59.95 Ea. |
| 11094  | 58-60 | Hardtop/Sedan/<br>Convertible | 283 4-Barrel Or 348          | 59.95 Ea. |
| 11095  | 58-60 | Wagon/El<br>Camino            | 6-Cylinder/283 2-Barrel      | 49.95 Ea. |
| 11096  | 58-60 | Wagon/El<br>Camino            | 283 4-Barrel Or 348          | 49.95 Ea. |
| 11097  | 61-64 | Hardtop/Sedan/<br>Convertible | 6-Cylinder/V8<br>(5/16 Line) | 54.95 Ea. |
| 11098  | 61-64 | Hardtop/Sedan/<br>Convertible | V8 Non-409 (3/8 Line)        | 54.95 Ea. |
| 15254  | 61-64 | Wagon                         | 5/16 Line                    | 50.95 Ea. |
| 11099  | 63-64 | Hardtop/Sedan/<br>Convertible | 409 Only                     | 79.95 Ea. |
| 11100  | 65-66 | Hardtop/Sedan/<br>Convertible | 5/16 Line                    | 54.95 Ea. |
| 11101  | 65-66 | Hardtop/Sedan/<br>Convertible | 3/8 Line                     | 54.95 Ea. |
| 11102  | 67    | Hardtop/Sedan/<br>Convertible | 327/396/427                  | 65.95 Ea. |
| 11102  | 68    | Hardtop/Sedan/<br>Convertible | 327/396                      | 65.95 Ea. |
| 11102  | 69    | Hardtop/Sedan/<br>Convertible | 427                          | 65.95 Ea. |
| 11102  | 70    | Hardtop/Sedan/<br>Convertible | V8                           | 65.95 Ea. |

## GAS CAPS



| Part # | Year  | Model         | Part    | Price     |
|--------|-------|---------------|---------|-----------|
| 5353   | 58-63 | All           | Gas Cap | 8.95 Ea.  |
| 15186  | 64    | All           | Gas Cap | 10.95 Ea. |
| 15187  | 65-69 | All Non-Wagon | Gas Cap | 7.95 Ea.  |
| 15186  | 65-70 | Wagon         | Gas Cap | 10.95 Ea. |

## FUEL FILTER ASSEMBLIES



| Part # | Year  | Model                    | Part                 | Price     |
|--------|-------|--------------------------|----------------------|-----------|
| 941    | 58-64 | All Except 409           | Fuel Filter Assembly | 29.95 Ea. |
| 15706  | 63-65 | 409 4Big Block or<br>2X4 | Fuel Filter Assembly | 65.95 Ea. |

# Glove Box

## GLOVE BOX BUMPERS



| Part# | Year  | Model | Part                  | Price     |
|-------|-------|-------|-----------------------|-----------|
| 233   | 58-70 | All   | Glove Box Lid Bumpers | 1.50 Pair |
| 11132 | 59-60 | All   | Glove Box Arm Bumper  | 4.00 Ea.  |
| 231A  | 61-64 | All   | Glove Box Arm Bumper  | 1.50 Ea.  |

## GLOVE BOX LATCHES



High-quality reproduction latch! Comes with screws.

| Part# | Year | Model | Part            | Price    |
|-------|------|-------|-----------------|----------|
| 11109 | 64   | All   | Glove Box Latch | 5.00 Ea. |

## GLOVE BOX LINERS



| Part# | Year  | Model  | Part   | Price     |
|-------|-------|--------|--|-----------|
| 11110 | 58    | All    | Glove Box Liner  | 15.95 Ea. |
| 11111 | 59-60 | All    | Glove Box Liner  | 15.95 Ea. |
| 11112 | 61-62 | w/AC   | Glove Box Liner  | 15.95 Ea. |
| 11113 | 61-62 | w/o AC | Glove Box Liner  | 15.95 Ea. |
| 11114 | 63-64 | w/AC   | Glove Box Liner  | 15.95 Ea. |
| 11115 | 63-64 | w/o AC | Glove Box Liner  | 15.95 Ea. |
| 11116 | 65-66 | w/AC   | Glove Box Liner<br>(Will Not Work w/Comfortron AC Systems) | 15.95 Ea. |
| 11117 | 65-66 | w/o AC | Glove Box Liner  | 15.95 Ea. |
| 11118 | 67    | w/AC   | Glove Box Liner  | 15.95 Ea. |
| 11119 | 67    | w/o AC | Glove Box Liner  | 15.95 Ea. |
| 11120 | 68    | w/o AC | Glove Box Liner  | 15.95 Ea. |
| 15644 | 68    | w/ AC  | Glove Box Liner  | 15.95 Ea. |
| 15707 | 69    | w/o AC | Glove Box Liner  | 15.95 Ea. |

## GLOVE BOX LOCKS



| Part# | Year  | Model | Part                    | Price     |
|-------|-------|-------|-------------------------|-----------|
| 11242 | 58-60 | All   | Glove Box Lock          | 28.95 Ea. |
| 1286  | 58-72 | All   | Glove Box Lock Retainer | 5.00 Ea.  |
| 1717  | 61-62 | All   | Glove Box Lock          | 27.95 Ea. |
| 11242 | 63    | All   | Glove Box Lock          | 28.95 Ea. |
| 16335 | 63    | All   | Glove Box Striker       | 11.95 Ea. |
| 11243 | 64    | All   | Glove Box Lock          | 28.95 Ea. |
| 11244 | 65-66 | All   | Glove Box Lock          | 28.95 Ea. |
| 11245 | 67    | All   | Glove Box Lock          | 28.95 Ea. |
| 11246 | 68    | All   | Glove Box Lock          | 29.95 Ea. |
| 11247 | 69-76 | All   | Glove Box Lock          | 25.95 Ea. |

## GLOVE BOX DOORS



| Part# | Year  | Model | Part           | Price      |
|-------|-------|-------|----------------|------------|
| 15664 | 63-64 | All   | Glove Box Door | 139.95 Ea. |

## GLOVE BOX EMBLEMS



| Part# | Year | Model     | Part                  | Price     |
|-------|------|-----------|-----------------------|-----------|
| 16268 | 65   | Impala    | Glove Box Door Emblem | 60.95 Ea. |
| 10681 | 66   | Impala SS | Glove Box Emblem      | 70.95 Ea. |



## GLOVE BOX LIGHT ASSEMBLIES



| Part# | Year  | Model | Part                     | Price     |
|-------|-------|-------|--------------------------|-----------|
| 5369  | 58-70 | All   | Glove Box Light Assembly | 15.95 Ea. |

# Generator Parts / Grilles

## GENERATOR BRACKETS

|   |   |   |
|---|---|---|
|  |  |  |
| <b>12968</b>  | <b>12969</b>  | <b>12970</b>  |





| Part# | Year  | Model   | Part                          | Price     |
|-------|-------|---------|-------------------------------|-----------|
| 12968 | 58-61 | 348     | Generator Bracket To Manifold | 33.95 Ea. |
| 12969 | 58-61 | 283/348 | Generator Bracket To Head     | 33.95 Ea. |
| 12970 | 58-61 | 348     | Generator Adjusting Bracket   | 33.95 Ea. |

## GRILLE EMBLEMS

|   |   |   |
|---|---|---|
|  |  |  |
| <b>10683</b>  | <b>10684</b>  | <b>10685</b>  |
|  |  |  |
| <b>10687</b>  | <b>10688</b>  | <b>10689</b>  |
|  |  |  |
| <b>10692</b>  | <b>10693</b>  | <b>10694</b>  |
|  |  |  |
| <b>10695</b>  | <b>10696</b>  | <b>10697</b>  |
|  |  |  |
| <b>10698</b>  | <b>10698</b>  | <b>12715</b>  |

| Part# | Year | Model         | Part                      | Price      |
|-------|------|---------------|---------------------------|------------|
| 10682 | 60   | 6-Cylinder    | Grille Emblem             | 109.95 Ea. |
| 10683 | 60   | 283           | Grille Emblem             | 109.95 Ea. |
| 10684 | 60   | 348           | Grille Emblem             | 99.95 Ea.  |
| 10685 | 61   | 6-Cylinder    | Grille Emblem             | 139.95 Ea. |
| 10686 | 61   | 283           | Grille Emblem             | 109.95 Ea. |
| 10687 | 61   | 348           | Grille Emblem             | 109.95 Ea. |
| 10688 | 64   | All           | Chevrolet Grille Emblem   | 39.95 Ea.  |
| 10689 | 65   | Impala SS     | Grille Emblem             | 65.95 Ea.  |
| 10690 | 65   | All           | Chevrolet Grille Emblem   | 49.95 Ea.  |
| 10691 | 66   | Impala        | Grille Emblem             | 65.95 Ea.  |
| 10692 | 66   | Impala SS     | Grille Emblem             | 69.95 Ea.  |
| 10693 | 67   | Impala SS     | Grille Emblem             | 109.95 Ea. |
| 10694 | 67   | Impala SS 427 | Grille Emblem             | 109.95 Ea. |
| 10695 | 68   | All w/o 427   | Blue Bowtie Grille Emblem | 38.95 Ea.  |
| 10696 | 68   | All w/427     | Red Bowtie Grille Emblem  | 38.95 Ea.  |
| 10697 | 68   | Impala SS     | Grille Emblem             | 129.95 Ea. |
| 10698 | 68   | Impala SS 427 | Grille Emblem             | 119.95 Ea. |
| 12715 | 69   | Impala SS     | Grille Emblem             | 89.95 Ea.  |

## GRILLES & BRACKETS

|  |              |
|--|--------------|
|  | <b>11126</b> |
|  | <b>13057</b> |
|  | <b>12726</b> |
|  | <b>11129</b> |
|  | <b>13185</b> |

| Part#              | Year | Model | Part   | Price      |
|--------------------|------|-------|--|------------|
| 11124              | 61   | All   | Upper Grille   | 259.95 Ea. |
| 11125              | 61   | All   | Lower Grille   | 479.95 Ea. |
| 11126              | 62   | All   | Grille   | 309.95 Ea. |
| 13057 <sup>②</sup> | 63   | All   | Grille (Comes w/ Parklight Housings Both Are RH, Will Have To Remove Locating Pin On LH Lens, Or Reuse Original Housing) | 529.95 Ea  |
| 12726 <sup>②</sup> | 64   | All   | Grille   | 419.95 Ea. |
| 11129 <sup>②</sup> | 65   | All   | Grille   | 509.95 Ea. |
| 13185              | 66   | All   | Lower Grille Set   | 209.95 Set |
| 15937              | 62   | All   | Grille Support Brackets  | 115.95 Set |
| 16307 <sup>③</sup> | 69   | All   | Upper Grille Assembly  | 389.95 Ea. |
| 16308 <sup>③</sup> | 69   | All   | Lower Grille Assembly  | 179.95 Ea. |

① = add \$8.95 handling per item  
 ② = add \$16.95 handling per item  
 ③ = add \$80.95 handling per item

# Grille Parts / Grommets / Headlights

## GRILLE HEADER PANELS



15786

| Part#   | Year | Model | Part                      | Price      |
|---------|------|-------|---------------------------|------------|
| 16136 ① | 65   | All   | Front Grille Header Panel | 159.95 Ea. |
| 15786 ① | 66   | All   | Front Grille Header Panel | 159.95 Ea. |

## GRILLE HEADER PANELS

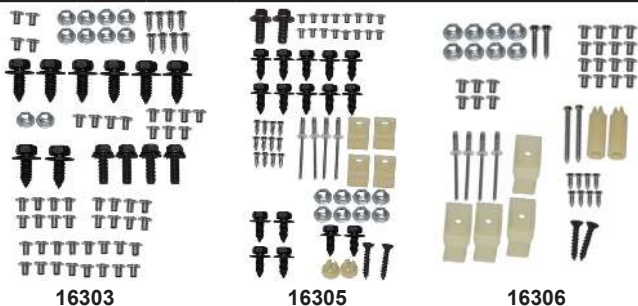

16303

16305

16306

| Part# | Year | Model | Part                | Price     |
|-------|------|-------|---------------------|-----------|
| 16303 | 61   | All   | Grille Hardware Kit | 25.95 Kit |
| 16304 | 63   | All   | Grille Hardware Kit | 15.95 Kit |
| 16305 | 64   | All   | Grille Hardware Kit | 20.95 Kit |
| 16306 | 65   | All   | Grille Hardware Kit | 13.95 Kit |

## GRILLE MOLDINGS



11122

11123

13069

12731

13072

13196

11412

11127

11479

| Part#   | Year | Model | Part                  | Price      |
|---------|------|-------|-----------------------|------------|
| 11122   | 59   | All   | Grille Screens        | 145.95 Set |
| 11123   | 59   | All   | Grille Knob Ornaments | 79.95 Set  |
| 13069   | 59   | All   | Grille Guard Bumpers  | 45.95 Pair |
| 12731   | 61   | All   | Grille Guard Bumpers  | 45.95 Pair |
| 16063   | 61   | All   | Grille Moldings       | 95.95 Pair |
| 13071 ① | 62   | All   | Grille Top Molding    | 65.95 Ea.  |
| 13072   | 62   | All   | Grille Top Teeth      | 29.95 Set  |
| 13196   | 62   | All   | Grille Guard          | 249.95 Ea. |
| 13197   | 63   | All   | Grille Guard Bumpers  | 8.95 Ea.   |
| 11412   | 63   | All   | Upper Grille Eyebrows | 89.95 Set  |
| 11127 ① | 63   | All   | Grille Guard          | 229.95 Ea. |
| 11128 ② | 64   | All   | Lower Grille Molding  | 69.95 Ea.  |
| 11479   | 67   | All   | Lower Grille Eyebrows | 55.95 Pair |

## GROMMETS



361

11133

11134

11135

11136

341

11137

11138

11139

| Part# | Year  | Model | Part                                   | Price     |
|-------|-------|-------|--|-----------|
| 361   | 58-60 | All   | Main Wiring Grommet                    | 9.95 Ea.  |
| 11133 | 58    | All   | Radiator Saddle Grommet                | 5.00 Ea.  |
| 11134 | 58    | All   | Inner Fender Radiator Support Grommets | 8.95 Set  |
| 11135 | 61-63 | All   | Filler Neck Grommet                    | 15.95 Ea. |
| 11136 | 64    | All   | Filler Neck Grommet                    | 5.50 Ea.  |
| 341   | 58-59 | All   | Speedometer Cable Grommet              | 4.00 Ea.  |
| 11137 | 62-64 | All   | Speedometer Cable Grommet              | 5.00 Ea.  |
| 15936 | 65-70 | All   | Speedometer Cable Grommet              | 6.95 Ea.  |
| 11138 | 59-60 | All   | Heater Cable Grommet                   | 5.00 Ea.  |
| 11139 | 58    | All   | Dimmer Switch Grommet                  | 5.95 Ea.  |

## HEADLIGHT BUCKETS

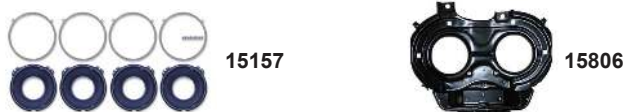

15157

15806

| Part# | Year  | Model | Part                           | Price      |
|-------|-------|-------|--------------------------------|------------|
| 15157 | 62-64 | All   | Headlight Bucket Set           | 109.95 Set |
| 15806 | 62    | All   | Headlight/Parklight Housing LH | 159.95 Ea. |
| 15807 | 62    | All   | Headlight/Parklight Housing RH | 159.95 Ea. |

## HEADLIGHT RETAINING RINGS



11152

11153

| Part# | Year  | Model | Part                     | Price     |
|-------|-------|-------|--------------------------|-----------|
| 11152 | 58-64 | All   | Headlight Retaining Ring | 6.95 Ea.  |
| 11153 | 65-72 | All   | Headlight Retaining Ring | 15.95 Ea. |

## HEADLIGHT SWITCHES



571

5408

11159

| Part# | Year  | Model | Part             | Price     |
|-------|-------|-------|------------------|-----------|
| 571   | 58-63 | All   | Headlight Switch | 39.95 Ea. |
| 5408  | 64-68 | All   | Headlight Switch | 18.95 Ea. |
| 11159 | 69    | All   | Headlight Switch | 18.95 Ea. |
| 11160 | 70    | All   | Headlight Switch | 39.95 Ea. |

① = add \$8.95 handling per item

② = add \$16.95 handling per item

# Headlights / Heater

## HEADLIGHT MOUNTING CUPS



| Part # | Year  | Model | Part                  | Price     |
|--------|-------|-------|-----------------------|-----------|
| 11154  | 58-66 | All   | Inner Mounting Cup LH | 42.95 Ea. |

## HEADLIGHT ADJUSTER KITS



13108



13109



13110

| Part # | Year  | Model | Part                   | Price     |
|--------|-------|-------|------------------------|-----------|
| 13108  | 58-61 | All   | Headlight Adjuster Kit | 12.95 Kit |
| 13109  | 62-64 | All   | Headlight Adjuster Kit | 7.95 Kit  |
| 13110  | 65-75 | All   | Headlight Adjuster Kit | 10.95 Kit |

## HEADLIGHT BEZEL RETAINING CLIPS



12830



12831



12832

| Part # | Year  | Model  | Part                           | Price    |
|--------|-------|--------|--------------------------------|----------|
| 12830  | 64    | All    | Headlight Bezel Retaining Clip | 1.95 Ea. |
| 12831  | 65    | Impala | Headlight Bezel Retaining Clip | 1.95 Ea. |
| 12832  | 66-67 | All    | Headlight Bezel Retaining Clip | 1.95 Ea. |

## HEADLIGHT BULBS



8500



8501



8502

- High power led headlight with 2 LED position light bar for powerful performance
- Dual function headlight: low beam & high beam
- Aluminum housing with proprietary heat management provides maximum protection for long-lasting performance
- Solid state design resists shock and vibration
- Easy connection, fits OEM housing or fender, plugs into existing wiring harness, position light requires additional wiring
- DOT/SAE headlight approved

| Part # | Year  | Model | Part                           | Price      |
|--------|-------|-------|--------------------------------|------------|
| 8500   | 58-70 | All   | Outer Low Beam Headlight Bulb  | 12.95 Ea.  |
| 8501   | 58-70 | All   | Inner High Beam Headlight Bulb | 12.95 Ea.  |
| 8502   | 58-70 | All   | Led Headlight Bulb             | 145.95 Ea. |

## HEADLIGHT KNOBS & SHAFTS



13047



13048



11161

| Part # | Year  | Model  | Part                   | Price     |
|--------|-------|--------|------------------------|-----------|
| 13047  | 61-63 | Impala | Headlight Knob & Shaft | 15.95 Ea. |
| 13048  | 64    | Impala | Headlight Knob & Shaft | 15.95 Ea. |
| 15688  | 65-66 | Impala | Headlight Knob & Shaft | 19.95 Ea. |
| 11161  | 67-68 | Impala | Headlight Knob & Shaft | 9.95 Ea.  |
| 11162  | 69-70 | Impala | Headlight Knob & Shaft | 19.95 Ea. |

## HEADLIGHT BEZELS



11144



11145



15188



15808



12874



11146



13137



11151



13067

| Part # | Year | Model | Part               | Price       |
|--------|------|-------|--------------------|-------------|
| 11144  | 58   | All   | Headlight Bezels   | 129.95 Pair |
| 11145  | 59   | All   | Headlight Bezels   | 149.95 Pair |
| 15188  | 61   | All   | Headlight Bezels   | 119.95 Pair |
| 15808  | 62   | All   | Headlight Bezels   | 139.95 Pair |
| 12874  | 63   | All   | Headlight Bezels   | 129.95 Set  |
| 11146  | 64   | All   | Headlight Bezels   | 55.95 Set   |
| 13137  | 65   | All   | Headlight Bezels   | 135.95 Set  |
| 11151  | 66   | All   | Headlight Bezels   | 139.95 Pair |
| 13067  | 67   | All   | Headlight Bezels   | 135.95 Pair |
| 16309  | 69   | All   | Headlight Bezel LH | 99.95 Ea.   |
| 16310  | 69   | All   | Headlight Bezel RH | 99.95 Ea.   |

## HEADLIGHT DIMMER SWITCHES



1351



11157



11158

| Part # | Year  | Model             | Part          | Price     |
|--------|-------|-------------------|---------------|-----------|
| 1351   | 58-60 | All               | Dimmer Switch | 27.95 Ea. |
| 11157  | 61    | All               | Dimmer Switch | 6.95 Ea.  |
| 11157  | 62    | w/o Automatic Dim | Dimmer Switch | 6.95 Ea.  |
| 11158  | 62    | w/Automatic Dim   | Dimmer Switch | 25.95 Ea. |
| 11157  | 63-70 | All               | Dimmer Switch | 6.95 Ea.  |

## HEATER RESISTORS



| Part # | Year  | Model  | Part            | Price     |
|--------|-------|--------|-----------------|-----------|
| 6107   | 58-70 | w/o AC | Heater Resistor | 18.95 Ea. |

# Heater

## HEATER CONTROL FACE



| Part # | Year  | Model | Part                | Price     |
|--------|-------|-------|---------------------|-----------|
| 5004   | 65-66 | w/AC  | Heater Control Face | 30.95 Ea. |

## HEATER CONTROL KNOBS



| Part # | Year  | Model  | Part                 | Price     |
|--------|-------|--------|----------------------|-----------|
| 15976  | 58    | w/o AC | Heater Control Knobs | 28.95 Set |
| 15977  | 59-60 | w/o AC | Heater Control Knobs | 28.95 Set |
| 15978  | 61-62 | w/o AC | Heater Control Knobs | 26.95 Set |
| 13152  | 63    | w/o AC | Heater Control Knobs | 38.95 Set |
| 13153  | 64    | w/o AC | Heater Control Knobs | 38.95 Set |
| 5433   | 65-70 | All    | Heater Control Knobs | 16.95 Set |

## HEATER CONTROL LEVERS



| Part # | Year  | Model  | Part                  | Price     |
|--------|-------|--------|-----------------------|-----------|
| 5005   | 65-66 | w/AC   | Heater Control Levers | 25.95 Set |
| 16034  | 65-66 | w/o AC | Heater Control Levers | 50.95 Set |
| 16035  | 65-66 | w/o AC | Heater Control Levers | 50.95 Set |

## VENT PULL KNOBS



| Part # | Year  | Model | Part                 | Price     |
|--------|-------|-------|----------------------|-----------|
| 11168  | 63-78 | All   | Vent Pull Knob Black | 18.95 Ea. |

## HEATER HOSES & CLAMPS



| Part # | Year  | Model | Part                              | Price     |
|--------|-------|-------|-----------------------------------|-----------|
| 11163  | 58    | All   | Heater Hoses w/Clamps             | 39.95 Set |
| 11164  | 59-64 | All   | Heater Hoses w/Clamps             | 39.95 Set |
| 11165  | 65-70 | All   | Heater Hoses Ww/Clamps            | 39.95 Set |
| 2180   | 55-68 | All   | Heater Hose Clamp 5/8"            | 1.50 Ea.  |
| 2181   | 55-68 | All   | Heater Hose Clamp 3/4"            | 1.50 Ea.  |
| 11166  | 69-74 | All   | Heater Hose Clamp 5/8"            | 5.00 Ea.  |
| 11167  | 69-74 | All   | Heater Hose Clamp 3/4"            | 5.00 Ea.  |
| 1916   | 58-62 | All   | Heater Hose To Inner Fender Clamp | 4.00 Ea.  |
| 15125  | 63-72 | All   | Heater Hose To Inner Fender Clamp | 5.00 Ea.  |

## HEATER SEALS



| Part # | Year  | Model      | Part                      | Price     |
|--------|-------|------------|---------------------------|-----------|
| 11170  | 58    | w/o AC     | Heater Box Seal Kit       | 13.95 Kit |
| 11172  | 61-62 | w/o AC     | Heater Box Seal Kit       | 25.95 Kit |
| 11173  | 63-64 | w/o AC     | Heater Box Seal Kit       | 8.95 Kit  |
| 11169  | 58    | All        | Plenum To Firewall Gasket | 7.95 Ea.  |
| 11171  | 59-62 | w/Air Flow | Blower Motor Seal         | 5.00 Ea.  |
| 11174  | 65-66 | w/o AC     | Heater To Firewall Seal   | 13.95 Ea. |
| 11175  | 65-68 | All        | Heater Core Firewall Seal | 13.95 Ea. |

## HEATER CONTROL ASSEMBLIES



| Part # | Year  | Model        | Part                    | Price      |
|--------|-------|--------------|-------------------------|------------|
| 5012   | 65-66 | w/Factory AC | Heater Control Assembly | 169.95 Ea. |

## HEATER CORES



| Part # | Year  | Model  | Part        | Price      |
|--------|-------|--------|-------------|------------|
| 16321  | 62    | w/o AC | Heater Core | 109.95 Ea. |
| 11330  | 63-68 | w/o AC | Heater Core | 99.95 Ea.  |
| 12716  | 63    | w/AC   | Heater Core | 95.95 Ea.  |
| 16318  | 64    | w/AC   | Heater Core | 89.95 Ea.  |
| 16319  | 65-68 | w/AC   | Heater Core | 99.95 Ea.  |
| 16320  | 69-70 | w/AC   | Heater Core | 75.95 Ea.  |
| 16322  | 69-70 | w/o AC | Heater Core | 69.95 Ea.  |
| 12717  | 69-70 | w/AC   | Heater Core | 75.95 Ea.  |

## HEATER CONTROL CABLES



| Part # | Year  | Model  | Part                  | Price     |
|--------|-------|--------|-----------------------|-----------|
| 13084  | 58    | w/o AC | Heater Control Cables | 39.95 Set |
| 13085  | 59-60 | w/o AC | Heater Control Cables | 39.95 Set |
| 13086  | 61    | w/o AC | Heater Control Cables | 39.95 Set |
| 13087  | 62    | w/o AC | Heater Control Cables | 39.95 Set |
| 13088  | 62    | w/AC   | Heater Control Cables | 53.95 Set |
| 13089  | 63    | w/o AC | Heater Control Cables | 39.95 Set |
| 13090  | 63    | w/AC   | Heater Control Cables | 39.95 Set |
| 13091  | 64    | w/o AC | Heater Control Cables | 39.95 Set |
| 13092  | 64    | w/AC   | Heater Control Cables | 69.95 Set |
| 13093  | 65-66 | w/o AC | Heater Control Cables | 43.95 Set |
| 13094  | 66    | w/AC   | Heater Control Cables | 43.95 Set |
| 13095  | 67-68 | w/o AC | Heater Control Cables | 45.95 Set |

# Heater / Hood Parts

## BLOWER MOTORS



| Part # | Year  | Model  | Part                   | Price     |
|--------|-------|--------|------------------------|-----------|
| 4388   | 58-63 | w/o AC | Universal Blower Motor | 75.95 Ea. |
| 21228  | 65-70 | All    | Blower Motor           | 45.95 Ea. |

## FRESH AIR VENT ASSEMBLIES



| Part # | Year | Model | Part                         | Price     |
|--------|------|-------|------------------------------|-----------|
| 15151  | 63   | All   | Assembly LH w/Chrome Knob    | 99.95 Ea. |
| 15152  | 63   | All   | Assembly RH w/Chrome Knob    | 99.95 Ea. |
| 15153  | 64   | All   | Assembly LH w/Black Knob     | 99.95 Ea. |
| 15154  | 64   | All   | Assembly RH w/Black Knob     | 99.95 Ea. |
| 15155  | 64   | All   | Assembly LH w/Chrome Knob    | 99.95 Ea. |
| 15156  | 64   | All   | Assembly RH w/Chrome Knob    | 99.95 Ea. |
| 15294  | 68   | All   | Fresh Air Vent Duct Seal Kit | 19.95 Kit |
| 15295  | 69   | All   | Fresh Air Vent Duct Seal Kit | 24.95 Kit |

## HEATER VALVES & SWITCHES



| Part # | Year  | Model  | Part                | Price      |
|--------|-------|--------|---------------------|------------|
| 16270  | 62    | w/o AC | Heater Valve        | 119.95 Ea. |
| 12805  | 63    | All    | Heater Valve Switch | 119.95 Ea. |
| 12713  | 68    | w/AC   | Heater Valve        | 49.95 Ea.  |
| 12714  | 69-70 | w/AC   | Heater Valve        | 55.95 Ea.  |

## HEATER SWITCHES



| Part # | Year  | Model  | Part                                | Price     |
|--------|-------|--------|-------------------------------------|-----------|
| 12797  | 58-62 | w/o AC | Heater Switch                       | 55.95 Ea. |
| 12798  | 63    | w/o AC | Heater Switch                       | 55.95 Ea. |
| 12799  | 64    | w/o AC | Heater Switch                       | 55.95 Ea. |
| 6300   | 65-66 | w/AC   | Heat/AC Switch (w/o Automatic Temp) | 16.95 Ea. |
| 12800  | 65-66 | w/o AC | Heater Switch                       | 55.95 Ea. |
| 12801  | 67-68 | w/o AC | Heater Switch                       | 29.95 Ea. |
| 16041  | 67-68 | w/AC   | Blower Switch                       | 43.95 Ea. |
| 12802  | 69-70 | w/o AC | Heater Switch                       | 55.95 Ea. |

① = add \$8.95 handling per item  
 ② = add \$16.95 handling per item

## AC & HEATER DUCT HOSES

| Part # | Year  | Model      | Part                        | Price     |
|--------|-------|------------|-----------------------------|-----------|
| 4350   | 58-70 | All 2"     | Plastic AC/Heater Duct Hose | 15.95 Ea. |
| 4351   | 58-70 | All 2-1/4" | Cloth AC/Heater Duct Hose   | 29.95 Ea. |
| 4352   | 58-70 | All 2-1/2" | Plastic AC/Heater Duct Hose | 15.95 Ea. |
| 4353   | 58-70 | All 2-3/4" | Plastic AC/Heater Duct Hose | 16.95 Ea. |
| 4354   | 58-70 | All 3"     | Plastic AC/Heater Duct Hose | 16.95 Ea. |

## HOOD INSULATION KITS



| Part # | Year  | Model | Part                           | Price     |
|--------|-------|-------|--------------------------------|-----------|
| 11177  | 58    | All   | Hood Insulation Kit            | 22.95 Kit |
| 4366①  | 58-70 | All   | 1/2" Universal Hood Insulation | 35.95 Ea. |
| 4367①  | 58-70 | All   | 1" Universal Hood Insulation   | 39.95 Ea. |
| 11178  | 59-60 | All   | Hood Insulation Kit            | 21.95 Kit |
| 11179  | 61    | All   | Hood Insulation Kit            | 16.95 Kit |
| 11180  | 62    | All   | Hood Insulation Kit            | 16.95 Kit |
| 11181  | 63    | All   | Hood Insulation Kit            | 16.95 Kit |
| 11182  | 64    | All   | Hood Insulation Kit            | 16.95 Kit |
| 11183  | 65-66 | All   | Hood Insulation Kit w/Clips    | 21.95 Kit |
| 11184  | 67-68 | All   | Hood Insulation Kit w/Clips    | 21.95 Kit |
| 11185  | 69-70 | All   | Hood Insulation Kit            | 35.95 Kit |
| 11186② | 59-60 | All   | Hood Insulation Retainer       | 59.95 Kit |
| 15135  | 64-70 | All   | Hood Insulation Clip           | 0.25 Ea.  |

## HOOD MOLDINGS



| Part # | Year | Model          | Part               | Price      |
|--------|------|----------------|--------------------|------------|
| 15759  | 60   | All            | Hood Lip Molding   | 209.95 Ea. |
| 11403  | 62   | All            | Hood Lip Molding   | 169.95 Ea. |
| 11411  | 63   | All            | Hood Lip Molding   | 199.95 Ea. |
| 11425  | 64   | All            | Hood Lip Molding   | 209.95 Ea. |
| 15224  | 67   | All            | Hood Lip Molding   | 209.95 Ea. |
| 11426  | 64   | All            | Hood Split Molding | 85.95 Ea.  |
| 11458  | 65   | Impala/Caprice | Hood Split Molding | 189.95 Ea. |
| 11476  | 66   | Impala/Caprice | Hood Split Molding | 229.95 Ea. |

# Hood Parts

## HOOD HINGE SPRINGS



11192

| Part # | Year  | Model | Part               | Price      |
|--------|-------|-------|--------------------|------------|
| 16146  | 59-60 | All   | Hood Hinge Springs | 55.95 Pair |
| 16147  | 61    | All   | Hood Hinge Springs | 55.95 Pair |
| 15980  | 62    | All   | Hood Hinge Spring  | 15.95 Ea.  |
| 11192  | 63-66 | All   | Hood Hinge Spring  | 20.95 Ea.  |
| 11193  | 67    | All   | Hood Hinge Spring  | 17.95 Ea.  |
| 11193  | 69    | All   | Hood Hinge Spring  | 17.95 Ea.  |
| 11192  | 70    | All   | Hood Hinge Spring  | 20.95 Ea.  |

## HOOD LATCH PARTS



13061



13062



15144

| Part # | Year | Model | Part                | Price     |
|--------|------|-------|---------------------|-----------|
| 16060  | 62   | All   | Hood Latch Assembly | 70.95 Ea. |
| 13061  | 63   | All   | Hood Latch Assembly | 65.95 Ea. |
| 13062  | 64   | All   | Hood Latch Assembly | 65.95 Ea. |
| 16061  | 62   | All   | Hood Latch Support  | 50.95 Ea. |
| 15143  | 65   | All   | Hood Latch Support  | 39.95 Ea. |
| 15144  | 66   | All   | Hood Latch Support  | 39.95 Ea. |

## BILLET ALUMINUM HOOD HINGES



16239



16252

| Part # | Year  | Model | Part                             | Price       |
|--------|-------|-------|----------------------------------|-------------|
| 16239★ | 61    | All   | Billet Alum Hood Hinges/Polished | 789.95 Pair |
| 16241★ | 61    | All   | Billet Alum Hood Hinges/Black    | 849.95 Pair |
| 16242★ | 62    | All   | Billet Alum Hood Hinges/Polished | 789.95 Pair |
| 16244★ | 62    | All   | Billet Alum Hood Hinges/Black    | 849.95 Pair |
| 15667★ | 63-64 | All   | Billet Alum Hood Hinges/Polished | 570.95 Pair |
| 16245★ | 63-64 | All   | Billet Alum Hood Hinges/Black    | 715.95 Pair |
| 16246★ | 65-67 | All   | Billet Alum Hood Hinges/Polished | 649.95 Pair |
| 16248★ | 65-67 | All   | Billet Alum Hood Hinges/Black    | 715.95 Pair |
| 16249★ | 68    | All   | Billet Alum Hood Hinges/Polished | 689.95 Pair |
| 16251★ | 68    | All   | Billet Alum Hood Hinges/Black    | 759.95 Pair |
| 16252★ | 69-70 | All   | Billet Alum Hood Hinges/Black    | 759.95 Pair |

## HOOD HINGES



11188



11190



15282



15967



15969



15971

| Part # | Year  | Model | Part                         | Price       |
|--------|-------|-------|------------------------------|-------------|
| 15513  | 62    | All   | Hood Hinges                  | 119.95 Pair |
| 11188  | 63-64 | All   | Hood Hinge LH                | 55.95 Ea.   |
| 11189  | 63-64 | All   | Hood Hinge RH                | 55.95 Ea.   |
| 11190  | 65-67 | All   | Hood Hinge LH                | 55.95 Ea.   |
| 11191  | 65-67 | All   | Hood Hinge RH                | 55.95 Ea.   |
| 15282  | 68    | All   | Hood Hinge LH                | 55.95 Ea.   |
| 15283  | 68    | All   | Hood Hinge RH                | 55.95 Ea.   |
| 15967  | 69    | All   | Hood Hinge LH                | 51.95 Ea.   |
| 15968  | 69    | All   | Hood Hinge RH                | 51.95 Ea.   |
| 15969  | 70    | All   | Hood Hinge LH                | 51.95 Ea.   |
| 15970  | 70    | All   | Hood Hinge RH                | 51.95 Ea.   |
| 15971  | 62    | All   | Hood Hinge Mounting Brace LH | 82.95 Ea.   |
| 15972  | 62    | All   | Hood Hinge Mounting Brace RH | 82.95 Ea.   |

## HOOD BUMPERS



11681



11682



11683



11684



11685



11686



11687



358



11688



15479

| Part # | Year  | Model | Part                    | Price     |
|--------|-------|-------|-------------------------|-----------|
| 11681  | 58    | All   | Hood Side Bumpers       | 7.95 Pair |
| 11682  | 59-61 | All   | Hood Side Bumpers       | 6.95 Pair |
| 11683  | 62    | All   | Hood Side Bumpers       | 5.00 Set  |
| 11684  | 63-64 | All   | Hood Side Bumpers       | 5.00 Set  |
| 11685  | 65    | All   | Hood Side Bumpers       | 6.95 Set  |
| 11686  | 66-72 | All   | Hood Side Bumpers       | 5.00 Set  |
| 11687  | 59    | All   | Hood To Grille Bumpers  | 3.00 Pair |
| 358    | 58-64 | All   | Hood Adjustment Bumpers | 3.95 Set  |
| 11688  | 68-70 | All   | Rear Hood Bumpers       | 3.00 Pair |
| 358B   | 58-62 | All   | Hood Stop Kit           | 8.95 Kit  |
| 15479  | 63-69 | All   | Hood Stop Kit           | 6.95 Kit  |

★ = special order non-stocking item, please allow 4-6 weeks for delivery.

# Horn Parts

## HORN PARTS



| Part # | Year  | Model                    | Part   | Price     |
|--------|-------|--------------------------|--|-----------|
| 255    | 58-62 | w/o Tilt                 | Upper Horn Contact/<br>Column Bearing Assembly | 19.95 Ea. |
| 1157   | 58-62 | All                      | Horn Contact w/Spring &<br>Brush               | 11.95 Ea. |
| 1162   | 58-62 | All                      | Horn Contact Insulator                         | 4.95 Ea.  |
| 244    | 58-60 | w/Horn Ring              | Horn Repair Kit                                | 18.95 Ea. |
| 245    | 61-63 | w/Horn Ring              | Horn Repair Kit                                | 18.95 Ea. |
| 1160   | 58-60 | Impala                   | Horn Ring Spacer                               | 3.50 Ea.  |
| 1161   | 62-63 | Impala                   | Horn Ring Spacer                               | 3.50 Ea.  |
| 1160   | 64    | Impala w/o<br>Wood Wheel | Horn Ring Spacer                               | 3.50 Ea.  |
| 1161   | 58-63 | Non-Impala               | Horn Ring Spacer                               | 2.50 Ea.  |
| 1163   | 58-75 | All                      | Horn Ring Retainer<br>Screws                   | 1.50 Set  |
| 1257   | 58-64 | All                      | Horn Ring Metal Spring                         | 7.95 Ea.  |
| 21308  | 67    | All Impala               | Horn Cap Mounting Kit                          | 35.95 Kit |
| 16508  | 66-70 | w/Wood<br>Wheel          | Horn Contact                                   | 15.95 Ea. |

## UNIVERSAL HORNS



| Part # | Year  | Model | Part            | Price       |
|--------|-------|-------|-----------------|-------------|
| 4133   | 58-70 | All   | Universal Horns | 109.95 Pair |

## HORN RINGS

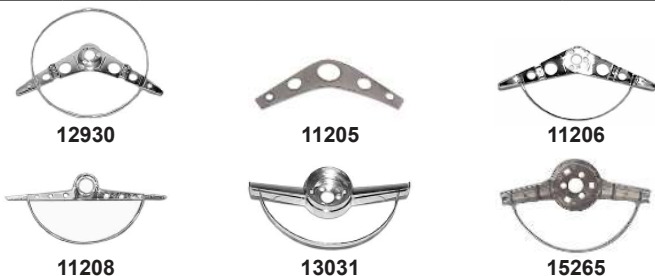

| Part # | Year  | Model  | Part                              | Price      |
|--------|-------|--------|-----------------------------------|------------|
| 12930  | 58    | Impala | Horn Ring ( <b>Chrome</b> )       | 119.95 Ea. |
| 11205  | 58-60 | Impala | Inner Horn Ring ( <b>Chrome</b> ) | 55.95 Ea.  |
| 11206  | 59-60 | Impala | Outer Horn Ring ( <b>Chrome</b> ) | 70.95 Ea.  |
| 15769  | 61    | Impala | Steering Wheel Center             | 55.95 Ea.  |
| 11207  | 62    | Impala | Horn Ring                         | 54.95 Ea.  |
| 11208  | 63    | Impala | Horn Ring                         | 54.95 Ea.  |
| 13031  | 64    | Impala | Horn Ring                         | 45.95 Ea.  |
| 15265  | 65-66 | All    | Horn Ring                         | 59.95 Ea.  |
| 15823  | 62-63 | Impala | Horn Ring Support                 | 45.95 Ea.  |

## HORN BUTTON ASSEMBLIES



| Part # | Year  | Model      | Part                  | Price      |
|--------|-------|------------|-----------------------|------------|
| 11195  | 64    | Impala     | Horn Button Assembly  | 65.95 Ea.  |
| 11196  | 64    | Wood Wheel | Horn Button Assembly  | 69.95 Ea.  |
| 11197  | 65    | Impala     | Horn Button Assembly  | 65.95 Ea.  |
| 11198  | 65    | Wood Wheel | Horn Button Assembly  | 69.95 Ea.  |
| 11199  | 64-65 | Belair     | Horn Cap              | 65.95 Ea.  |
| 11200  | 66    | Impala     | Horn Button Assembly  | 69.95 Ea.  |
| 11201  | 66    | Wood Wheel | Horn Button Assembly  | 65.95 Ea.  |
| 11202  | 67-69 | Wood Wheel | Horn Button Assembly  | 49.95 Ea.  |
| 11203  | 69-70 | Impala     | Horn Buttons Black    | 19.95 Pair |
| 15323  | 69-70 | Impala     | Horn Buttons Dk Blue  | 19.95 Pair |
| 15324  | 69-70 | Impala     | Horn Buttons Dk Green | 19.95 Pair |
| 15325  | 69-70 | Impala     | Horn Buttons Red      | 19.95 Pair |
| 11204  | 69-70 | Impala     | Horn Contact Buttons  | 19.95 Pair |

## HORN BUTTON EMBLEMS



| Part # | Year  | Model     | Part                    | Price     |
|--------|-------|-----------|-------------------------|-----------|
| 10708  | 58-60 | Impala    | Horn Ring Emblem        | 35.95 Ea. |
| 10709  | 62-63 | Impala    | Horn Ring Emblem        | 19.95 Ea. |
| 10709  | 62    | Impala SS | Horn Ring Emblem        | 19.95 Ea. |
| 10710  | 63    | Impala SS | Horn Ring Emblem        | 19.95 Ea. |
| 10711  | 64    | Impala    | Horn Ring Emblem        | 35.95 Ea. |
| 10712  | 67    | Impala SS | Horn Ring Emblem        | 44.95 Ea. |
| 10713  | 67    | All       | Horn Ring Bowtie Emblem | 44.95 Ea. |
| 10714  | 69    | Impala SS | Horn Pad Emblem         | 11.95 Ea. |

# Horn Parts / Handles

## HORN RELAYS



| Part # | Year  | Model | Part       | Price     |
|--------|-------|-------|------------|-----------|
| 15350  | 58    | All   | Horn Relay | 49.95 Ea. |
| 565    | 62    | All   | Horn Relay | 25.95 Ea. |
| 15484  | 63-65 | All   | Horn Relay | 35.95 Ea. |
| 15485  | 66-70 | All   | Horn Relay | 75.95 Ea. |

## VENT WINDOW CRANK HANDLES



| Part # | Year  | Model            | Part                    | Price     |
|--------|-------|------------------|-------------------------|-----------|
| 12936  | 58    | Impala           | Vent Window Handle      | 22.95 Ea. |
| 12862  | 59-60 | Impala           | Vent Window Handle      | 12.95 Ea. |
| 13148  | 61-64 | Impala & SS      | Vent Window Handle      | 12.95 Ea. |
| 12063  | 65-66 | Impala & SS      | Vent Window Handle      | 14.95 Ea. |
| 12062  | 58-60 | Belair/ Biscayne | Vent Window Handle      | 11.95 Ea. |
| 12062  | 61-64 | Biscayne         | Vent Window Handle      | 11.95 Ea. |
| 13150  | 65-66 | Biscayne         | Vent Window Handle      | 12.95 Ea. |
| 220    | 58-70 | All              | Handle Plastic Washer   | 1.50 Ea.  |
| 12938  | 58    | Impala           | Handle Escutcheon Bezel | 13.95 Ea. |

## OUTSIDE DOOR HANDLE GASKETS



| Part # | Year  | Model | Part                     | Price    |
|--------|-------|-------|--------------------------|----------|
| 10609  | 58    | All   | Door Handle/Lock Gaskets | 5.95 Set |
| 10610  | 59    | All   | Door Handle/Lock Gaskets | 4.95 Set |
| 10611  | 60    | All   | Door Handle/Lock Gaskets | 4.95 Set |
| 10612  | 61-62 | All   | Door Handle/Lock Gaskets | 4.95 Set |
| 10613  | 63-64 | All   | Door Handle/Lock Gaskets | 4.95 Set |
| 15205  | 65-66 | All   | Door Handle/Lock Gaskets | 4.95 Set |
| 10614  | 69-70 | All   | Door Handle/Lock Gaskets | 5.00 Set |

## WINDOW CRANK HANDLES



| Part # | Year  | Model            | Part                       | Price     |
|--------|-------|------------------|----------------------------|-----------|
| 12937  | 58    | Impala           | Window Handle              | 22.95 Ea. |
| 12861  | 59-60 | Impala           | Window Handle              | 12.95 Ea. |
| 13147  | 61-64 | Impala & SS      | Window Handle              | 12.95 Ea. |
| 12059  | 65-66 | Impala & SS      | Window Handle              | 14.95 Ea. |
| 12058  | 58-60 | Belair/ Biscayne | Window Handle              | 11.95 Ea. |
| 12058  | 61-64 | Biscayne         | Window Handle              | 11.95 Ea. |
| 13149  | 65-66 | Biscayne         | Window Handle              | 22.95 Ea. |
| 12060  | 67-81 | All              | Window Handle (Clear Knob) | 6.95 Ea.  |
| 5446   | 67-81 | All              | Window Handle (Black Knob) | 6.95 Ea.  |
| 220    | 58-70 | All              | Handle Plastic Washer      | 1.50 Ea.  |
| 12938  | 58    | Impala           | Handle Escutcheon Bezel    | 13.95 Ea. |

## INSIDE DOOR HANDLES



| Part # | Year  | Model            | Part                               | Price      |
|--------|-------|------------------|------------------------------------|------------|
| 12935  | 58    | Impala           | Inside Door Handle                 | 22.95 Ea.  |
| 10586  | 58-60 | Belair/ Biscayne | Inside Door Handle                 | 11.95 Ea.  |
| 16002  | 61-64 | Belair           | Inside Door Handle                 | 28.95 Ea.  |
| 10586  | 61-64 | Biscayne         | Inside Door Handle                 | 11.95 Ea.  |
| 10587  | 65-67 | Belair/ Biscayne | Inside Door Handle                 | 14.95 Ea.  |
| 10588  | 59-67 | Impala/ Caprice  | Inside Door Handle                 | 49.95 Pair |
| 10589  | 68-70 | All              | Inside Door Handle LH              | 13.95 Ea.  |
| 10590  | 68-70 | All              | Inside Door Handle RH              | 13.95 Ea.  |
| 220    | 58-70 | All              | Handle Plastic Washer              | 1.50 Ea.   |
| 12938  | 58    | Impala           | Handle Escutcheon Bezel            | 13.95 Ea.  |
| 5894   | 58-70 | All              | Inside Door/Window Handle Retainer | 0.15 Ea.   |

# Handles / Ignition

## OUTSIDE DOOR HANDLES

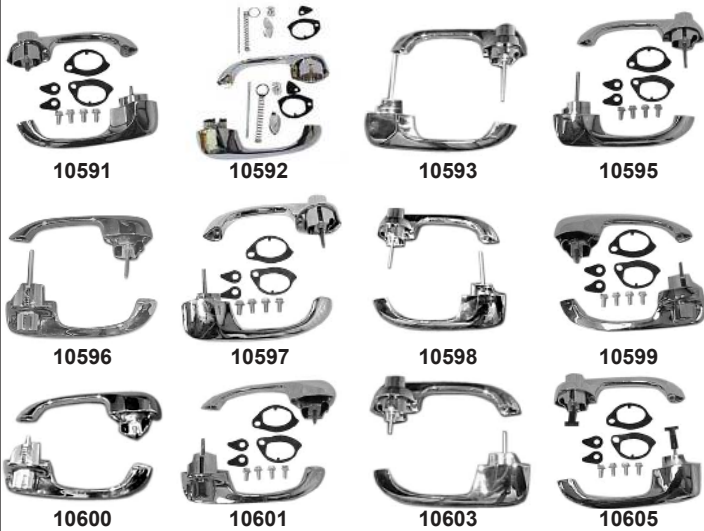

| Part# | Year  | Model  | Part                 | Price       |
|-------|-------|--------|----------------------|-------------|
| 10591 | 58    | All    | Outside Door Handles | 145.95 Pair |
| 10592 | 59    | All    | Outside Door Handles | 119.95 Pair |
| 10593 | 60    | 2-Dr   | Outside Door Handles | 99.95 Pair  |
| 10594 | 60    | 4-Dr   | Front Door Handles   | 99.95 Pair  |
| 10595 | 60    | 4-Dr   | Rear Door Handles    | 99.95 Pair  |
| 10596 | 61-62 | 2/4-Dr | Front Door Handles   | 99.95 Pair  |
| 10597 | 61-62 | 4-Dr   | Rear Door Handles    | 99.95 Pair  |
| 10598 | 63-64 | 2/4-Dr | Front Door Handles   | 99.95 Pair  |
| 10599 | 63-64 | 4-Dr   | Rear Door Handles    | 99.95 Pair  |
| 10600 | 65-68 | 2-Dr   | Outside Door Handles | 99.95 Pair  |
| 10601 | 65-68 | 4-Dr   | Front Door Handles   | 109.95 Pair |
| 10602 | 65-68 | 4-Dr   | Rear Door Handles    | 109.95 Pair |
| 10603 | 69-70 | 2-Dr   | Outside Door Handles | 99.95 Pair  |
| 10604 | 69-70 | 4-Dr   | Front Door Handles   | 99.95 Pair  |
| 10605 | 69-70 | 4-Dr   | Rear Door Handles    | 99.95 Pair  |

## IGNITION WIRE SHIELDS



| Part# | Year  | Model          | Part              | Price     |
|-------|-------|----------------|-------------------|-----------|
| 579   | 64-69 | Small Block V8 | Plug Wire Shields | 39.95 Set |

## IGNITION KEYS AND TUMBLERS



These correct reproduction lock sets include one tumbler and two pre-coded keys. Pawls not included!

| Part# | Year  | Model  | Part                   | Price    |
|-------|-------|--------|------------------------|----------|
| 470   | 58-64 | All    | Ignition Key & Tumbler | 16.95 Ea |
| 5439  | 65    | Impala | Ignition Key & Tumbler | 15.95 Ea |
| 5443  | 66-67 | Impala | Ignition Key & Tumbler | 16.95 Ea |
| 16299 | 69-70 | Impala | Ignition Key & Tumbler | 14.95 Ea |

## IGNITION / DOOR LOCK SETS



| Part# | Year  | Model | Part                              | Price     |
|-------|-------|-------|-----------------------------------|-----------|
| 1068  | 58    | All   | Ignition/Lock Set (Short Pawl)    | 55.95 Set |
| 11235 | 58    | All   | Ignition/Lock Set (Long Pawl)     | 52.95 Set |
| 11236 | 59-60 | All   | Ignition/Lock Set (Long Cylinder) | 55.95 Set |
| 11237 | 61-64 | All   | Ignition/Lock Set (Short Pawl)    | 55.95 Set |
| 11235 | 61-64 | All   | Ignition/Lock Set (Long Pawl)     | 52.95 Set |
| 11238 | 65    | All   | Ignition/Lock Set                 | 52.95 Set |
| 11239 | 66-67 | All   | Ignition/Lock Set                 | 39.95 Set |
| 11241 | 69-70 | All   | Ignition/Lock Set                 | 35.95 Set |

## IGNITION SWITCHES



| Part# | Year  | Model  | Part                  | Price      |
|-------|-------|--------|-----------------------|------------|
| 15819 | 58    | All    | Ignition Switch       | 105.95 Ea. |
| 6546  | 61-63 | All    | Ignition Switch       | 16.95 Ea.  |
| 16073 | 64    | All    | Ignition Switch       | 30.95 Ea.  |
| 11211 | 67    | All    | Ignition Switch       | 45.95 Ea.  |
| 11212 | 69-70 | All    | Ignition Switch       | 29.95 Ea.  |
| 11213 | 61-64 | Impala | Ignition Switch Bezel | 11.95 Ea.  |
| 12876 | 65-66 | All    | Ignition Switch Bezel | 9.95 Ea.   |

## SPARK PLUG WIRE RETAINERS



| Part# | Year  | Model | Part                                | Price    |
|-------|-------|-------|-------------------------------------|----------|
| 13191 | 64-71 | V8    | Spark Plug Wire Retainer (Small)    | 3.00 Ea. |
| 13192 | 64-69 | V8    | Spark Plug Wire Retainer (Lg)       | 6.95 Ea. |
| 13193 | 64-71 | V8    | Spark Plug Wire Retainer On Oil Pan | 7.95 Ea. |

# Ignition / Lights

## BREAKERLESS IGNITION CONVERSION



2555

Allows you to keep original appearance while upgrading your original distributor from points and condenser to late model breakerless ignition.

| Part # | Year  | Model | Part                | Price      |
|--------|-------|-------|---------------------|------------|
| 2555   | 58-74 | V8    | Ignition Conversion | 169.95 Kit |

## PARKLIGHT LENS BEZELS



10102



15824

| Part # | Year | Model | Part                  | Price       |
|--------|------|-------|-----------------------|-------------|
| 10102  | 59   | All   | Parklight Lens Bezels | 105.95 Pair |
| 15824  | 60   | All   | Parklight Lens Bezel  | 35.95 Ea.   |

## BACKUP LIGHT LENSES & TRIM



10073

10075

10074

13200

10076

10078

13203

10084

15114

10086

10081

15494

10083

13036

13042

| Part # | Year | Model               | Part                                | Price     |
|--------|------|---------------------|-------------------------------------|-----------|
| 10072  | 58   | All                 | Backup Light Lens                   | 9.95 Ea.  |
| 10073  | 59   | All                 | Backup Light Lens                   | 10.95 Ea. |
| 10087  | 59   | All                 | Housing Gaskets                     | 4.00 Set  |
| 10075  | 60   | Belair/<br>Biscayne | Backup Light Lenses                 | 9.95 Ea.  |
| 10074  | 60   | Impala              | Backup Light Lens                   | 9.95 Ea.  |
| 13030  | 60   | All                 | Led Backup Light Lens               | 64.95 Ea. |
| 10075  | 61   | All                 | Backup Light Lenses                 | 9.95 Pair |
| 13200  | 61   | All                 | Backup Light Lens w/Blue Dot        | 11.95 Ea. |
| 10076  | 62   | Impala              | Backup Light Lens                   | 9.95 Ea.  |
| 15101  | 62   | Impala              | Backup Light Lens w/Bowtie          | 20.95 Ea. |
| 15104  | 62   | Impala              | Backup Light Lens w/Blue Dot Bowtie | 23.95 Ea. |
| 15488  | 62   | All                 | Led Backup Light Lens               | 65.95 Ea. |
| 10078  | 63   | Belair/<br>Biscayne | Backup Light Lens                   | 19.95 Ea. |
| 10077  | 63   | Impala              | Backup Light Lens                   | 11.95 Ea. |
| 15106  | 63   | Impala              | Backup Light Lens w/Bowtie          | 22.95 Ea. |
| 13203  | 63   | Impala              | Backup Light Lens w/Blue Dot        | 14.95 Ea. |
| 15109  | 63   | Impala              | Backup Light Lens w/Blue Dot Bowtie | 23.95 Ea. |

| Part # | Year  | Model              | Part                                | Price      |
|--------|-------|--------------------|-------------------------------------|------------|
| 15490  | 63    | All                | Led Backup Lens                     | 65.95 Ea.  |
| 10084  | 63    | Impala             | Backup/Taillight Lens Trim          | 16.95 Ea.  |
| 10079  | 64    | Impala             | Backup Light Lens                   | 11.95 Ea.  |
| 15111  | 64    | Impala             | Backup Light Lens w/Bowtie          | 21.95 Ea.  |
| 13205  | 64    | Impala             | Backup Light Lens w/Blue Dot        | 14.95 Ea.  |
| 15114  | 64    | Impala             | Backup Light Lens w/Blue Dot Bowtie | 23.95 Ea.  |
| 15492  | 64    | All                | Led Backup Light Lens               | 65.95 Ea.  |
| 10086  | 64    | Impala             | Backup Light Lens Trim              | 10.95 Ea.  |
| 10081  | 65    | Impala             | Backup Light Lens                   | 14.95 Ea.  |
| 13207  | 65    | Impala             | Backup Light Lens w/Blue Dot        | 24.95 Ea.  |
| 15494  | 65    | All                | Led Backup Light Lens               | 65.95 Ea.  |
| 10083  | 66    | Impala             | Backup Light Lens                   | 32.95 Pair |
| 15266  | 66    | Impala             | Backup Light Lens Gaskets           | 3.95 Pair  |
| 10083  | 66-67 | Caprice            | Backup Light Lens                   | 32.95 Pair |
| 13036  | 68    | Caprice            | Backup Light Lens                   | 39.95 Ea.  |
| 15269  | 68    | Impala             | Backup Light Lens                   | 21.95 Ea.  |
| 15643  | 68    | Impala/<br>Caprice | Led Backup Light Lenses             | 69.95 Ea.  |
| 13042  | 69    | Impala             | Backup Light Lens                   | 26.95 Ea.  |

## PARKLIGHT ASSEMBLIES



12860



15803

| Part # | Year | Model | Part                  | Price     |
|--------|------|-------|-----------------------|-----------|
| 12860  | 64   | All   | Parklight Assembly    | 55.95 Ea. |
| 15803  | 68   | All   | Parklight Assembly LH | 49.95 Ea. |
| 15804  | 68   | All   | Parklight Assembly RH | 49.95 Ea. |

## PARKLIGHT HOUSING GASKETS

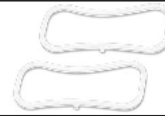

| Part # | Year | Model | Part                      | Price    |
|--------|------|-------|---------------------------|----------|
| 10103  | 64   | All   | Parklight Housing Gaskets | 6.95 Set |

# Lights

## PARKLIGHT HOUSINGS



15806



15252

| Part # | Year | Model | Part   | Price      |
|--------|------|-------|--|------------|
| 16334  | 60   | All   | Parklight Housing  | 33.95 Ea.  |
| 15806  | 62   | All   | Headlight/Parklight Housing LH   | 149.95 Ea. |
| 15807  | 62   | All   | Headlight/Parklight Housing RH   | 149.95 Ea. |
| 15252  | 63   | All   | Parklight Housing<br>(Correct Reproduction Of RH Side. Can Be Used On LH Side By Removing The Locating Pin On The Lens.) | 31.95 Ea.  |

## PARKLIGHT LENS GASKETS



10140



10142



10144

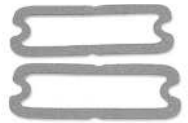

10146



10147



10148

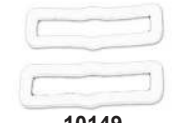

10149



15267

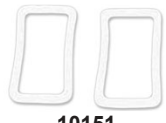

10151

| Part # | Year | Model           | Part                         | Price     |
|--------|------|-----------------|------------------------------|-----------|
| 10140  | 58   | All             | Parklight Lens Gaskets       | 6.95 Set  |
| 10141  | 59   | All             | Parklight Lens Gaskets       | 5.50 Set  |
| 10142  | 60   | All             | Parklight Lens Gaskets       | 6.95 Set  |
| 10143  | 61   | All             | Parklight Lens Gaskets       | 6.95 Set  |
| 10144  | 62   | All             | Parklight Lens Gaskets       | 6.95 Set  |
| 10145  | 63   | All             | Parklight Lens Gaskets       | 6.95 Set  |
| 10146  | 64   | All             | Parklight Lens Gaskets       | 6.95 Set  |
| 10147  | 65   | All             | Parklight Lens Gaskets       | 4.00 Set  |
| 10148  | 66   | All             | Parklight Lens Gaskets       | 5.00 Set  |
| 10149  | 67   | All             | Parklight Lens Gaskets       | 4.00 Set  |
| 15267  | 67   | Impala/ Caprice | Fender Running Light Gaskets | 3.95 Pair |
| 10150  | 68   | All             | Parklight Lens Gaskets       | 5.00 Set  |
| 10151  | 70   | All             | Parklight Lens Gaskets       | 5.00 Set  |

## SIDE MARKER LIGHT GASKETS



10164



10165

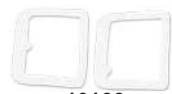

10166

| Part # | Year | Model | Part                            | Price    |
|--------|------|-------|---------------------------------|----------|
| 10164  | 68   | All   | Front Marker Gaskets            | 3.50 Set |
| 10165  | 68   | All   | Rear Marker Light Gaskets       | 3.50 Set |
| 10166  | 68   | All   | Front Cornering Lt Lens Gaskets | 5.00 Set |

## PARKLIGHT LENSES



10088



10090



10091



10094



10096



10097



10098



10099



10100



10101



13038

| Part # | Year | Model | Part                     | Price      |
|--------|------|-------|--------------------------|------------|
| 10088  | 58   | All   | Parklight Lens Clear     | 13.95 Ea.  |
| 16166  | 58   | All   | Led Parklight Lens Amber | 39.95 Ea.  |
| 16167  | 58   | All   | Led Parklight Lens Clear | 39.95 Ea.  |
| 10089  | 59   | All   | Parklight Lens Clear     | 25.95 Pair |
| 10090  | 59   | All   | Parklight Lens Amber     | 25.95 Pair |
| 10091  | 60   | All   | Parklight Lens Clear     | 35.95 Pair |
| 10092  | 60   | All   | Parklight Lens Amber     | 35.95 Pair |
| 10093  | 61   | All   | Parklight Lens Clear     | 12.95 Pair |
| 10094  | 61   | All   | Parklight Lens Amber     | 12.95 Pair |
| 10095  | 62   | All   | Parklight Lens Clear     | 29.95 Pair |
| 10096  | 62   | All   | Parklight Lens Amber     | 29.95 Pair |
| 15158  | 63   | All   | Parklight Lens Clear     | 16.95 Pair |
| 10097  | 63   | All   | Parklight Lens Amber     | 15.95 Pair |
| 15159  | 64   | All   | Parklight Lens Clear     | 35.95 Pair |
| 10098  | 64   | All   | Parklight Lens Amber     | 22.95 Pair |
| 15160  | 65   | All   | Parklight Lens Clear     | 35.95 Pair |
| 10099  | 65   | All   | Parklight Lens Amber     | 22.95 Pair |
| 15179  | 66   | All   | Parklight Lens Clear     | 42.95 Pair |
| 10100  | 66   | All   | Parklight Lens Amber     | 24.95 Pair |
| 16168  | 66   | All   | Led Parklight Lens Amber | 42.95 Ea.  |
| 15180  | 67   | All   | Parklight Lens Clear     | 42.95 Pair |
| 10101  | 67   | All   | Parklight Lens Amber     | 19.95 Pair |
| 16169  | 67   | All   | Led Parklight Lens Amber | 42.95 Ea.  |
| 15501  | 68   | All   | Parklight Lens Amber     | 17.95 Pair |
| 13038  | 69   | All   | Parklight Lens Amber     | 8.95 Ea.   |

# Lights

## BLUE DOTS

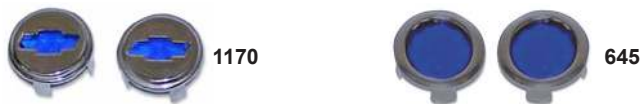

| Part # | Year  | Model | Part                          | Price      |
|--------|-------|-------|-------------------------------|------------|
| 1170   | 58-70 | All   | Bowtie Blue Dots              | 22.95 Pair |
| 645    | 58-70 | All   | Glass Blue Dots w/Chrome Trim | 7.95 Pair  |

## SIDE MARKER LIGHT LENSES & BEZELS



| Part # | Year | Model | Part                     | Price       |
|--------|------|-------|--------------------------|-------------|
| 20118  | 68   | All   | Front Marker Light Lens  | 15.95 Ea.   |
| 11923  | 68   | 307   | Front Marker Light Bezel | 95.95 Pair  |
| 11924  | 68   | 327   | Front Marker Light Bezel | 95.95 Pair  |
| 11925  | 68   | 350   | Front Marker Light Bezel | 95.95 Pair  |
| 11926  | 68   | 396   | Front Marker Light Bezel | 95.95 Pair  |
| 11927  | 68   | 427   | Front Marker Light Bezel | 95.95 Pair  |
| 11928  | 68   | All   | Rear Marker Light Bezel  | 89.95 Pair  |
| 20119  | 69   | All   | Front Marker Light Lens  | 12.95 Ea.   |
| 11929  | 69   | 327   | Front Marker Light Bezel | 109.95 Pair |
| 11930  | 69   | 350   | Front Marker Light Bezel | 109.95 Pair |
| 11931  | 69   | 396   | Front Marker Light Bezel | 109.95 Pair |
| 11932  | 69   | 427   | Front Marker Light Bezel | 109.95 Pair |
| 12724  | 69   | All   | Rear Marker Light Bezel  | 89.95 Pair  |

## FRONT CORNER LIGHTS



| Part # | Year | Model | Part                    | Price     |
|--------|------|-------|-------------------------|-----------|
| 15115  | 68   | All   | Front Cornering Lens LH | 29.95 Ea. |
| 15116  | 68   | All   | Front Cornering Lens RH | 29.95 Ea. |

## 1958-59 TAILLIGHT LENSES



| Part # | Year | Model                     | Part                        | Price      |
|--------|------|---------------------------|-----------------------------|------------|
| 10104  | 58   | All                       | Taillight Lens              | 14.95 Ea.  |
| 13198  | 58   | All                       | Taillight Lens w/Blue Dot   | 9.95 Ea.   |
| 10106  | 59   | Hardtop/Sedan/Convertible | Taillight Lens LH           | 22.95 Ea.  |
| 10107  | 59   | Hardtop/Sedan/Convertible | Taillight Lens RH           | 22.95 Ea.  |
| 13392  | 59   | El Camino/Wagon           | Taillight Lens Set          | 199.95 Set |
| 15793  | 59   | All                       | Led Taillight Conversion LH | 69.95 Ea.  |
| 15794  | 59   | All                       | Led Taillight Conversion RH | 69.95 Ea.  |

## 1960-61 TAILLIGHT LENSES



| Part # | Year  | Model | Part                      | Price     |
|--------|-------|-------|---------------------------|-----------|
| 10110  | 60-61 | All   | Taillight Lens            | 7.95 Ea.  |
| 13199  | 60-61 | All   | Taillight Lens w/Blue Dot | 11.95 Ea. |
| 13029  | 60-61 | All   | Led Taillight Lens        | 29.95 Ea. |
| 15636  | 60-61 | All   | Led Clear Taillight Lens  | 31.95 Ea. |

## 1962 TAILLIGHT LENSES



| Part # | Year | Model | Part                             | Price     |
|--------|------|-------|----------------------------------|-----------|
| 10112  | 62   | All   | Taillight Lens                   | 7.95 Ea.  |
| 15100  | 62   | All   | Taillight Lens w/Bowtie          | 20.95 Ea. |
| 15102  | 62   | All   | Clear Taillight Lens w/Bowtie    | 20.95 Ea. |
| 13201  | 62   | All   | Taillight Lens w/Blue Dot        | 10.95 Ea. |
| 15103  | 62   | All   | Taillight Lens w/Blue Dot Bowtie | 23.95 Ea. |
| 15487  | 62   | All   | Led Taillight Lens               | 32.95 Ea. |
| 15637  | 62   | All   | Led Clear Taillight Lens         | 31.95 Ea. |

# Lights

## 1963 TAILLIGHT LENSES



| Part # | Year | Model            | Part                             | Price     |
|--------|------|------------------|----------------------------------|-----------|
| 10115  | 63   | Belair/ Biscayne | Taillight Lens                   | 15.95 Ea. |
| 10114  | 63   | Impala           | Taillight Lens                   | 7.95 Ea.  |
| 15105  | 63   | Impala           | Taillight Lens w/Bowtie          | 22.95 Ea. |
| 15107  | 63   | Impala           | Clear Taillight Lens w/Bowtie    | 21.95 Ea. |
| 13202  | 63   | Impala           | Taillight Lens w/Blue Dot        | 19.95 Ea. |
| 15108  | 63   | Impala           | Taillight Lens w/Blue Dot Bowtie | 23.95 Ea. |
| 15489  | 63   | All              | Led Taillight Lens               | 32.95 Ea. |
| 15638  | 63   | All              | Led Clear Taillight Lens         | 31.95 Ea. |

## 1964 TAILLIGHT LENSES



| Part # | Year | Model        | Part                             | Price     |
|--------|------|--------------|----------------------------------|-----------|
| 10116  | 64   | Impala       | Taillight Lens                   | 7.95 Ea.  |
| 15110  | 64   | Impala       | Taillight Lens w/Bowtie          | 21.95 Ea. |
| 15112  | 64   | Impala       | Clear TI Lens w/Bowtie           | 21.95 Ea. |
| 13204  | 64   | Impala       | Taillight Lens w/Blue Dot        | 9.95 Ea.  |
| 15113  | 64   | Impala       | Taillight Lens w/Blue Dot Bowtie | 23.95 Ea. |
| 13034  | 64   | Impala Wagon | Taillight Lens                   | 25.95 Ea. |
| 15491  | 64   | All          | Led Taillight Lens               | 32.95 Ea. |
| 15639  | 64   | All          | Led Clear Taillight Lens         | 32.95 Ea. |

## 1965 TAILLIGHT LENSES



| Part # | Year | Model  | Part                      | Price     |
|--------|------|--------|---------------------------|-----------|
| 10118  | 65   | Impala | Taillight Lens            | 16.95 Ea. |
| 13206  | 65   | Impala | Taillight Lens w/Blue Dot | 14.95 Ea. |
| 15493  | 65   | All    | Led Taillight Lens        | 32.95 Ea. |
| 15640  | 65   | All    | Led Clear Taillight Lens  | 32.95 Ea. |

## TAILLIGHT BULBS



| Part # | Year  | Model | Part                     | Price     |
|--------|-------|-------|--------------------------|-----------|
| 7133   | 58-70 | All   | Red 1157 Taillight Bulbs | 3.00 Pair |

## 1966 TAILLIGHT LENSES



| Part # | Year | Model   | Part              | Price     |
|--------|------|---------|-------------------|-----------|
| 10122  | 66   | Impala  | Taillight Lens LH | 58.95 Ea. |
| 10123  | 66   | Impala  | Taillight Lens RH | 58.95 Ea. |
| 10124  | 66   | Caprice | Taillight Lens LH | 59.95 Ea. |
| 10125  | 66   | Caprice | Taillight Lens RH | 59.95 Ea. |

## 1967 TAILLIGHT LENSES

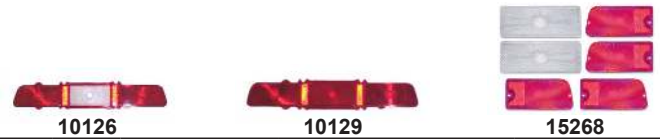

| Part # | Year | Model         | Part              | Price      |
|--------|------|---------------|-------------------|------------|
| 10126  | 67   | Belair/Impala | Taillight Lens LH | 69.95 Ea.  |
| 10127  | 67   | Belair/Impala | Taillight Lens RH | 69.95 Ea.  |
| 10128  | 67   | Caprice       | Taillight Lens LH | 55.95 Ea.  |
| 10129  | 67   | Caprice       | Taillight Lens RH | 55.95 Ea.  |
| 15268  | 67   | Wagon         | Taillight Lens    | 169.95 Set |

## 1968-70 TAILLIGHT LENSES



| Part # | Year | Model          | Part                     | Price     |
|--------|------|----------------|--------------------------|-----------|
| 13035  | 68   | Caprice        | Taillight Lens           | 39.95 Ea. |
| 15270  | 68   | Impala         | Taillight Lens           | 18.95 Ea. |
| 13039  | 69   | Impala         | Taillight Lens LH        | 22.95 Ea. |
| 13040  | 69   | Impala         | Taillight Lens Center    | 22.95 Ea. |
| 13041  | 69   | Impala         | Taillight Lens RH        | 22.95 Ea. |
| 15343  | 70   | Impala         | Taillight Lens Set       | 99.95 Set |
| 15641  | 68   | Impala/Caprice | Led Taillight Lens       | 35.95 Ea. |
| 15642  | 68   | Impala/Caprice | Led Clear Taillight Lens | 35.95 Ea. |

## LED FLASHERS



| Part # | Year  | Model | Part                   | Price     |
|--------|-------|-------|------------------------|-----------|
| 3977   | 58-70 | W/Led | 2-Terminal Led Flasher | 11.95 Ea. |
| 3978   | 58-70 | W/Led | 3-Terminal Led Flasher | 12.95 Ea. |

# Lights

## TAILLIGHT HOUSINGS & BASES



| Part # | Year | Model    | Part                              | Price      |
|--------|------|----------|-----------------------------------|------------|
| 15514  | 60   | All      | Taillight Base                    | 32.95 Ea.  |
| 15515  | 60   | All      | Backup Light Base                 | 32.95 Ea.  |
| 15258  | 61   | All      | Taillight Housing                 | 17.95 Ea.  |
| 13033  | 62   | Impala   | Taillight Bases                   | 83.95 Pair |
| 13144  | 63   | Impala   | Taillight Base LH                 | 39.95 Ea.  |
| 13145  | 63   | Impala   | Taillight Base RH                 | 39.95 Ea.  |
| 13146  | 64   | Impala   | Taillight Base                    | 39.95 Ea.  |
| 16066  | 65   | Impala   | Taillight/Backup Light Housing LH | 19.95 Ea.  |
| 16067  | 65   | Impala   | Taillight/Backup Light Housing RH | 19.95 Ea.  |
| 16290  | 65   | All      | Taillight/Backup Light Housing RH | 19.95 Ea.  |
| 16291  | 65   | All      | Taillight/Backup Light Housing LH | 19.95 Ea.  |
| 16292  | 65   | Biscayne | Backup Light Housing LH           | 19.95 Ea.  |
| 16293  | 65   | Biscayne | Backup Light Housing RH           | 19.95 Ea.  |

## TAILLIGHT & BACKUP LIGHT LENS KITS W/ TRIM

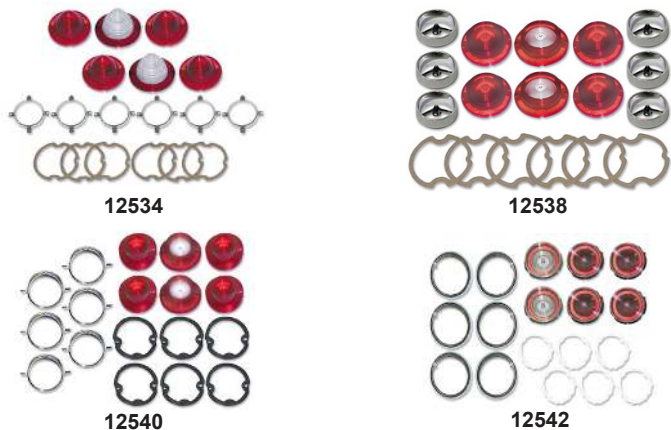

Each of these reproduction kits includes 2 backup light lenses, 4 taillight lenses, 6 trim bezels and gaskets.

| Part # | Year | Model  | Part                           | Price      |
|--------|------|--------|--------------------------------|------------|
| 12534  | 61   | Impala | Taillight & Backup Lt Lens Kit | 69.95 Kit  |
| 12538  | 63   | Impala | Taillight & Backup Lt Lens Kit | 131.95 Kit |
| 12540  | 64   | Impala | Taillight & Backup Lt Lens Kit | 100.95 Kit |
| 12542  | 65   | Impala | Taillight & Backup Lt Lens Kit | 183.95 Kit |

## TAILLIGHT ASSEMBLIES



| Part # | Year | Model            | Part               | Price      |
|--------|------|------------------|--------------------|------------|
| 10105  | 58   | Impala           | Taillight Assembly | 275.95 Set |
| 13032  | 62   | Impala           | Taillight Assembly | 229.95 Set |
| 16336  | 63   | All Except Wagon | Taillight Assembly | 199.95 Set |
| 13208  | 64   | Impala           | Taillight Assembly | 209.95 Set |

## TAILLIGHT BEZELS & TRIM



| Part # | Year | Model                   | Part                        | Price       |
|--------|------|-------------------------|-----------------------------|-------------|
| 10111  | 61   | All                     | Taillight Trim              | 6.95 Ea.    |
| 10113  | 62   | Impala                  | Taillight Trim              | 7.95 Ea.    |
| 10084  | 63   | Impala                  | Taillight/Backup Light Trim | 16.95 Ea.   |
| 10086  | 64   | Impala                  | Taillight/Backup Light Trim | 10.95 Ea.   |
| 10119  | 65   | All                     | Taillight Trim LH           | 19.95 Ea.   |
| 10120  | 65   | All                     | Taillight Trim RH           | 19.95 Ea.   |
| 13154  | 66   | Impala                  | Taillight Bezel LH          | 39.95 Ea.   |
| 13155  | 66   | Impala                  | Taillight Bezel RH          | 39.95 Ea.   |
| 15117  | 67   | All                     | Taillight Bezels            | 219.95 Pair |
| 12989  | 58   | Impala                  | Taillight Bezel             | 25.95 Ea.   |
| 10108  | 59   | Non-Wagon/<br>El Camino | Taillight Lens Bezel        | 219.95 Pair |
| 10109  | 59   | All                     | Taillight Lens Trim         | 39.95 Set   |

## TAILLIGHT LENS GASKETS

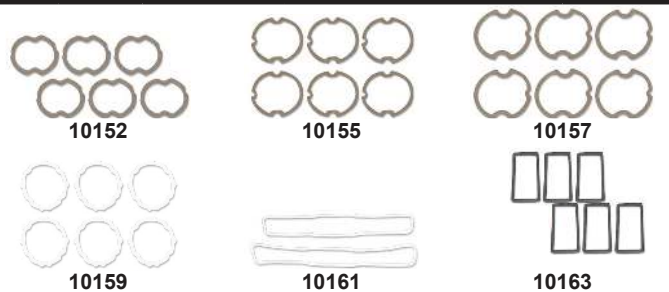

| Part # | Year | Model  | Part                   | Price    |
|--------|------|--------|------------------------|----------|
| 10152  | 58   | All    | Taillight Lens Gaskets | 7.95 Set |
| 10153  | 59   | All    | Taillight Lens Gaskets | 8.95 Set |
| 10154  | 60   | All    | Taillight Lens Gaskets | 8.95 Set |
| 10155  | 61   | All    | Taillight Lens Gaskets | 8.95 Set |
| 10156  | 62   | All    | Taillight Lens Gaskets | 8.95 Set |
| 10157  | 63   | All    | Taillight Lens Gaskets | 8.95 Set |
| 10158  | 64   | All    | Taillight Lens Gaskets | 8.95 Set |
| 10159  | 65   | Impala | Taillight Lens Gaskets | 9.95 Set |
| 10160  | 66   | Impala | Taillight Lens Gaskets | 5.00 Set |
| 10161  | 67   | All    | Taillight Lens Gaskets | 7.95 Set |
| 10162  | 68   | All    | Taillight Lens Gaskets | 9.95 Set |
| 10163  | 70   | Impala | Taillight Lens Gaskets | 9.95 Set |

# Lights / Light Gaskets

## TAILLIGHT & BACKUP LIGHT LENS KITS

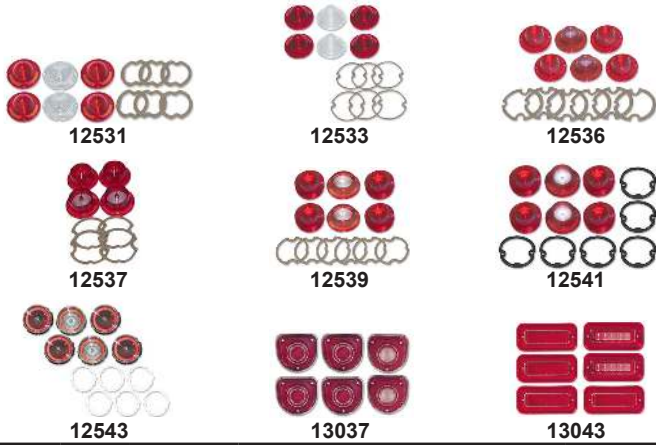

Each of these reproduction kits includes 2 backup light lenses, 4 taillight lenses and gaskets. Trim not included. **Part #12537 only comes with 2 taillight lenses. Part #'s 13037 and 13043 do not come with gaskets.**

| Part # | Year | Model               | Part                              | Price      |
|--------|------|---------------------|-----------------------------------|------------|
| 12531  | 58   | Impala              | Taillight & Backup Light Lens Kit | 69.95 Kit  |
| 12533  | 60   | Impala              | Taillight & Backup Light Lens Kit | 46.95 Kit  |
| 12535  | 61   | Impala              | Taillight & Backup Light Lens Kit | 38.95 Kit  |
| 12536  | 62   | Impala              | Taillight & Backup Light Lens Kit | 46.95 Kit  |
| 12537  | 63   | Belair/<br>Biscayne | Taillight & Backup Light Lens Kit | 65.95 Kit  |
| 12539  | 63   | Impala              | Taillight & Backup Light Lens Kit | 49.95 Kit  |
| 12541  | 64   | Impala              | Taillight & Backup Light Lens Kit | 49.95 Kit  |
| 12543  | 65   | Impala              | Taillight & Backup Light Lens Kit | 86.95 Kit  |
| 13037  | 68   | Caprice             | Taillight & Backup Light Lens Kit | 169.95 Kit |
| 13043  | 69   | Impala              | Taillight & Backup Light Lens Kit | 129.95 Kit |

## TAILLIGHT LENS KITS



Each of these reproduction kits includes 2 taillight lenses and gaskets. Manufactured for a flawless installation!

| Part # | Year | Model         | Part               | Price      |
|--------|------|---------------|--------------------|------------|
| 12532  | 59   | Impala        | Taillight Lens Kit | 44.95 Kit  |
| 12544  | 66   | Impala        | Taillight Lens Kit | 103.95 Kit |
| 12545  | 66   | Caprice       | Taillight Lens Kit | 105.95 Kit |
| 12546  | 67   | Belair/Impala | Taillight Lens Kit | 123.95 Kit |
| 12547  | 67   | Caprice       | Taillight Lens Kit | 99.95 Kit  |

## SIDE MARKER LIGHT GASKETS



| Part # | Year | Model | Part                            | Price    |
|--------|------|-------|---------------------------------|----------|
| 10164  | 68   | All   | Front Marker Gaskets            | 3.50 Set |
| 10165  | 68   | All   | Rear Marker Light Gaskets       | 3.50 Set |
| 10166  | 68   | All   | Front Cornering Lt Lens Gaskets | 5.00 Set |

## TAILLIGHT LENS GASKETS

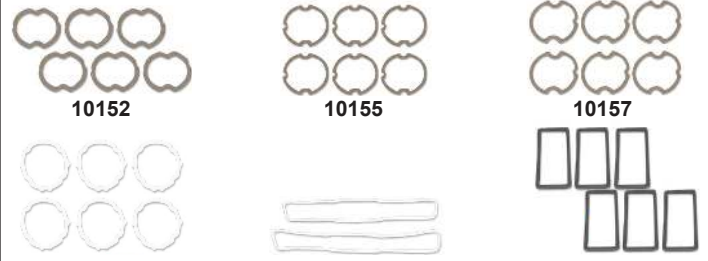

| Part # | Year | Model  | Part                   | Price    |
|--------|------|--------|------------------------|----------|
| 10152  | 58   | All    | Taillight Lens Gaskets | 7.95 Set |
| 10153  | 59   | All    | Taillight Lens Gaskets | 8.95 Set |
| 10154  | 60   | All    | Taillight Lens Gaskets | 8.95 Set |
| 10155  | 61   | All    | Taillight Lens Gaskets | 8.95 Set |
| 10156  | 62   | All    | Taillight Lens Gaskets | 8.95 Set |
| 10157  | 63   | All    | Taillight Lens Gaskets | 8.95 Set |
| 10158  | 64   | All    | Taillight Lens Gaskets | 8.95 Set |
| 10159  | 65   | Impala | Taillight Lens Gaskets | 9.95 Set |
| 10160  | 66   | Impala | Taillight Lens Gaskets | 5.00 Set |
| 10161  | 67   | All    | Taillight Lens Gaskets | 7.95 Set |
| 10162  | 68   | All    | Taillight Lens Gaskets | 9.95 Set |
| 10163  | 70   | Impala | Taillight Lens Gaskets | 9.95 Set |

## LENS GASKET SETS

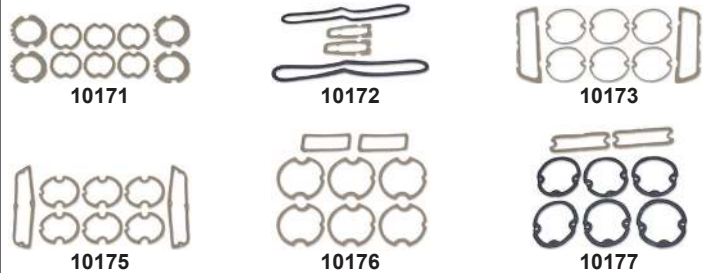

| Part # | Year | Model | Part            | Price     |
|--------|------|-------|-----------------|-----------|
| 10171  | 58   | All   | Lens Gasket Set | 12.95 Set |
| 10172  | 59   | All   | Lens Gasket Set | 12.95 Set |
| 10173  | 60   | All   | Lens Gasket Set | 12.95 Set |
| 10174  | 61   | All   | Lens Gasket Set | 12.95 Set |
| 10175  | 62   | All   | Lens Gasket Set | 12.95 Set |
| 10176  | 63   | All   | Lens Gasket Set | 12.95 Set |
| 10177  | 64   | All   | Lens Gasket Set | 12.95 Set |

## Light Gaskets / License Plate Parts

### TAILLIGHT HOUSING & ASSEMBLY GASKETS



| Part # | Year  | Model             | Part                             | Price     |
|--------|-------|-------------------|----------------------------------|-----------|
| 10130  | 58    | Impala            | Taillight Housing Seals          | 15.95 Set |
| 10131  | 59    | All               | Taillight Housing Gasket         | 9.95 Ea.  |
| 10132  | 60    | All               | Taillight Assembly To Body Seals | 10.95 Set |
| 10133  | 61    | All               | Taillight Housing To Body Seals  | 10.95 Set |
| 10134  | 61    | All               | Inner Taillight Housing Seals    | 5.95 Set  |
| 10135  | 62-63 | All               | Housing To Body Seals            | 19.95 Set |
| 10136  | 62    | Belair/<br>Impala | Inner Taillight Housing Seal     | 9.95 Set  |
| 10137  | 63    | Belair/<br>Impala | Inner Taillight Housing Seal     | 6.95 Set  |
| 15966  | 64    | Impala            | Taillight Housing To Body Seals  | 28.95 Set |
| 10138  | 65    | Impala            | Taillight Housing Gaskets        | 9.95 Set  |
| 10139  | 65    | All               | Under Taillight Dust Seals       | 10.95 Set |

### LICENSE LIGHT LENSES

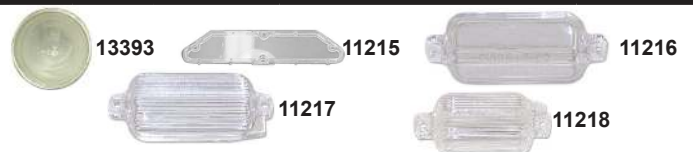

| Part # | Year  | Model     | Part               | Price     |
|--------|-------|-----------|--------------------|-----------|
| 13393  | 59    | El Camino | License Light Lens | 24.95 Ea. |
| 11215  | 60    | All       | License Light Lens | 22.95 Ea. |
| 11216  | 61-64 | All       | License Light Lens | 9.95 Ea.  |
| 11217  | 65    | All       | License Light Lens | 9.95 Ea.  |
| 11218  | 66-70 | All       | License Light Lens | 19.95 Ea. |

### LICENSE LIGHT GASKETS



| Part # | Year  | Model | Part                         | Price    |
|--------|-------|-------|------------------------------|----------|
| 10167  | 59    | All   | License Light Gasket         | 2.95 Ea. |
| 10168  | 59    | All   | License Light Housing Gasket | 2.00 Ea. |
| 10169  | 61-64 | All   | License Light Lens Gasket    | 2.50 Ea. |
| 10170  | 66-72 | All   | License Light Lens Gasket    | 3.00 Ea. |

### LICENSE LIGHT ASSEMBLIES



| Part # | Year  | Model     | Part                   | Price     |
|--------|-------|-----------|------------------------|-----------|
| 11219  | 60    | All       | License Light Assembly | 94.95 Ea. |
| 13156  | 61-64 | All       | License Light Assembly | 30.95 Ea. |
| 16009  | 65    | Non-Wagon | License Light Assembly | 27.95 Ea. |
| 15335  | 66-69 | Non-Wagon | License Light Assembly | 25.95 Ea. |

### LICENSE PLATE FRAMES



| Part # | Year | Model | Part                          | Price     |
|--------|------|-------|-------------------------------|-----------|
| 11234  | 58   | All   | Accessory License Plate Frame | 65.95 Ea. |
| 12688  | 58   | All   | Chevrolet License Plate Frame | 9.95 Ea.  |
| 12689  | 59   | All   | Chevrolet License Plate Frame | 9.95 Ea.  |
| 12690  | 60   | All   | Chevrolet License Plate Frame | 9.95 Ea.  |
| 12691  | 61   | All   | Chevrolet License Plate Frame | 9.95 Ea.  |
| 12692  | 62   | All   | Chevrolet License Plate Frame | 9.95 Ea.  |
| 12693  | 63   | All   | Chevrolet License Plate Frame | 9.95 Ea.  |
| 12694  | 64   | All   | Chevrolet License Plate Frame | 9.95 Ea.  |
| 12695  | 65   | All   | Chevrolet License Plate Frame | 9.95 Ea.  |
| 12696  | 66   | All   | Chevrolet License Plate Frame | 9.95 Ea.  |
| 12697  | 67   | All   | Chevrolet License Plate Frame | 9.95 Ea.  |
| 12698  | 68   | All   | Chevrolet License Plate Frame | 9.95 Ea.  |
| 12699  | 69   | All   | Chevrolet License Plate Frame | 9.95 Ea.  |
| 12700  | 70   | All   | Chevrolet License Plate Frame | 9.95 Ea.  |

### LICENSE PLATE BRACKETS

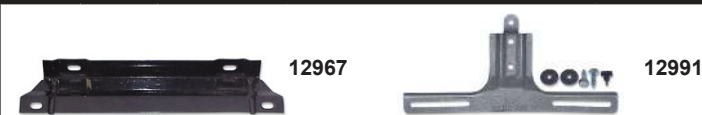

| Part # | Year  | Model     | Part  | Price     |
|--------|-------|-----------|---|-----------|
| 12967  | 58    | All       | Front License Plate Bracket                     | 28.95 Ea. |
| 12991  | 58    | All       | Rear License Plate Bracket<br>W/Continental Kit | 16.95 Ea. |
| 20309  | 68-69 | Non Wagon | Rear License Plate Bracket                      | 29.95 Ea. |
| 15530  | 65    | All       | Rear Bumper Center Support                      | 60.95 Ea. |

# License Plate Parts / Lock Sets

## LICENSE PLATE PANELS



12965



10286



11220



11221



11223



11225



12966



13020



11229



11231

| Part #  | Year | Model     | Part                | Price     |
|---------|------|-----------|---------------------|-----------|
| 12965 ① | 58   | All       | License Panel Front | 99.95 Ea. |
| 10286 ① | 60   | All       | License Panel Front | 69.95 Ea. |
| 11220   | 61   | All       | License Panel Front | 59.95 Ea. |
| 11221 ① | 62   | All       | License Panel Front | 59.95 Ea. |
| 11223 ① | 63   | All       | License Panel Front | 69.95 Ea. |
| 11225 ① | 64   | All       | License Panel Front | 59.95 Ea. |
| 12966 ① | 58   | Non-Wagon | License Panel Rear  | 99.95 Ea. |
| 13020   | 61   | Non-Wagon | License Panel Rear  | 59.95 Ea. |
| 11227 ① | 62   | Non-Wagon | License Panel Rear  | 59.95 Ea. |
| 11229 ① | 63   | Non-Wagon | License Panel Rear  | 69.95 Ea. |
| 11231 ① | 64   | Non-Wagon | License Panel Rear  | 59.95 Ea. |

## DOOR / TRUNK / GLOVE BOX LOCK SETS



11250



11253



11256

These correct reproduction lock sets include a trunk lock tumbler, glove box tumbler, 2 door lock tumblers and two pre-coded keys. Pawls not included!

| Part # | Year  | Model | Part                          | Price     |
|--------|-------|-------|-------------------------------|-----------|
| 11250  | 58    | All   | Lock Set w/Long Pawl Only     | 60.95 Set |
| 11251  | 61-62 | All   | Lock Set w/Long Pawl Only     | 59.95 Set |
| 11252  | 63    | All   | Lock Set w/Long Pawl Only     | 60.95 Set |
| 11253  | 64    | All   | Lock Set w/Long Pawl Only     | 60.95 Set |
| 11254  | 65-66 | All   | Door/Trunk/Glove Box Lock Set | 60.95 Set |
| 11255  | 67    | All   | Door/Trunk/Glove Box Lock Set | 60.95 Set |
| 11256  | 68    | All   | Door/Trunk/Glove Box Lock Set | 63.95 Set |
| 11257  | 69-70 | All   | Door/Trunk/Glove Box Lock Set | 59.95 Set |

## IGNITION / DOOR LOCK SETS



1068



11235



11238

| Part # | Year  | Model | Part                               | Price     |
|--------|-------|-------|------------------------------------|-----------|
| 1068   | 58    | All   | Ignition/Door Lock w/Short Pawl    | 55.95 Set |
| 11235  | 58    | All   | Ignition/Door Lock w/Long Pawl     | 52.95 Set |
| 11236  | 59-60 | All   | Ignition/Door Lock w/Long Cylinder | 55.95 Set |
| 11237  | 61-64 | All   | Ignition/Door Lock w/Short Pawl    | 55.95 Set |
| 11235  | 61-64 | All   | Ignition/Door Lock w/Long Pawl     | 52.95 Set |
| 11238  | 65    | All   | Ignition/Door Lock Set             | 52.95 Set |
| 11239  | 66-67 | All   | Ignition/Door Lock Set             | 39.95 Set |
| 11241  | 69-70 | All   | Ignition/Door Lock Set             | 35.95 Set |

## INDIVIDUAL LOCK SETS



470



1717



1890



11263



1718



1073

These correct reproduction lock sets include one tumbler and two pre-coded keys. Pawls not included!

| Part # | Year  | Model  | Part                       | Price      |
|--------|-------|--------|----------------------------|------------|
| 470    | 58-64 | All    | Ignition Key & Tumbler     | 16.95 Ea   |
| 5439   | 65    | Impala | Ignition Key & Tumbler     | 15.95 Ea   |
| 5443   | 66-67 | Impala | Ignition Key & Tumbler     | 16.95 Ea   |
| 16299  | 69-70 | Impala | Ignition Key & Tumbler     | 14.95 Ea   |
| 11242  | 58-60 | All    | Glove Box Lock w/Keys      | 28.95 Ea   |
| 1717   | 61-62 | All    | Glove Box Lock w/Keys      | 27.95 Ea   |
| 11242  | 63    | All    | Glove Box Lock w/Keys      | 28.95 Ea   |
| 11243  | 64    | All    | Glove Box Lock w/Keys      | 28.95 Ea   |
| 11244  | 65-66 | All    | Glove Box Lock w/Keys      | 28.95 Ea   |
| 11245  | 67    | All    | Glove Box Lock w/Keys      | 28.95 Ea   |
| 11246  | 68    | All    | Glove Box Lock w/Keys      | 29.95 Ea   |
| 11247  | 69-70 | All    | Glove Box Lock w/Keys      | 25.95 Ea   |
| 1717   | 65-67 | All    | Console Lock w/Keys        | 27.95 Ea   |
| 22539  | 62-64 | All    | Console Lock w/Keys        | 24.95 Ea   |
| 1890   | 58    | All    | Door Locks w/Short Pawl    | 40.95 Pair |
| 11258  | 58    | All    | Door Locks w/Long Pawl     | 35.95 Pair |
| 11259  | 59-60 | All    | Door Locks w/Long Cylinder | 42.95 Pair |
| 11260  | 61-64 | All    | Door Locks w/Flat Pawl     | 36.95 Pair |
| 11261  | 61-64 | All    | Door Locks w/Long Pawl     | 31.95 Pair |
| 11262  | 65-66 | All    | Door Locks                 | 29.95 Pair |
| 11263  | 67-68 | All    | Door Locks                 | 27.95 Pair |
| 11264  | 69-70 | All    | Door Locks                 | 22.95 Pair |
| 1718   | 58    | All    | Trunk Lock w/Keys          | 23.95 Ea   |
| 11248  | 59    | All    | Trunk Lock w/Keys          | 35.95 Ea   |
| 11249  | 60-68 | All    | Trunk Lock w/Keys          | 20.95 Ea   |
| 1073   | 58-67 | All    | Trunk Lock Shaft & Spring  | 3.00 Ea    |
| 13068  | 68-70 | All    | Trunk Lock Shaft & Spring  | 3.00 Ea    |

① = add \$8.95 handling per item

# Lock Sets / Lokar Products

## IGNITION / DOOR / TRUNK LOCK SETS



These correct reproduction lock sets include a trunk lock tumbler, ignition tumbler, 2 door lock tumblers and two pre-coded keys. Pawls not included!

| Part# | Year  | Model | Part                         | Price     |
|-------|-------|-------|------------------------------|-----------|
| 11265 | 58    | All   | Lock Set w/Short Pawl        | 68.95 Set |
| 11266 | 58    | All   | Lock Set w/Long Pawl         | 68.95 Set |
| 11267 | 59    | All   | Lock Set w/Long Cylinder     | 89.95 Set |
| 11268 | 60    | All   | Lock Set w/Long Cylinder     | 75.95 Set |
| 11269 | 61-64 | All   | Lock Set w/Short Pawl        | 68.95 Set |
| 11270 | 61-64 | All   | Lock Set w/Long Pawl         | 68.95 Set |
| 11271 | 65    | All   | Ignition/Door/Trunk Lock Set | 52.95 Set |
| 11272 | 66    | All   | Ignition/Door/Trunk Lock Set | 53.95 Set |

## COMPLETE LOCK SETS



Sets include trunk lock tumbler, ignition tumbler, glove box tumbler, 2 door lock tumblers and 2 pre-coded keys. Pawls not included!

| Part# | Year  | Model | Part                  | Price     |
|-------|-------|-------|-----------------------|-----------|
| 11273 | 58    | All   | Lock Set w/Short Pawl | 89.95 Set |
| 11274 | 58    | All   | Lock Set w/Long Pawl  | 89.95 Set |
| 11275 | 61-62 | All   | Lock Set w/Short Pawl | 85.95 Set |
| 11276 | 61-62 | All   | Lock Set w/Long Pawl  | 85.95 Set |
| 11277 | 63    | All   | Lock Set w/Short Pawl | 89.95 Set |
| 11278 | 63    | All   | Lock Set w/Long Pawl  | 85.95 Set |
| 11279 | 64    | All   | Lock Set w/Short Pawl | 89.95 Set |
| 11280 | 64    | All   | Lock Set w/Long Pawl  | 85.95 Set |
| 11281 | 65    | All   | Complete Lock Set     | 74.95 Set |
| 11282 | 66    | All   | Complete Lock Set     | 74.95 Set |



**QUALITY... PLAIN & SIMPLE®**

American Quality... Plain & Simple

For over two decades Lokar has manufactured products of the highest quality, exceeding industry standards, raising the bar for quality products and leading the way for a better automotive aftermarket. We dedicate ourselves to providing all customers with original and innovative products. This dedication has translated into an unwavering reputation that we are proud of and which customers remind us of every day. When one builds a company on Honesty, Integrity and Class, everything else falls into place. Lokar is a name built by our customers.

It is Lokar's steadfast belief of "Made in the USA", that sets us apart from others. It would be easy to stray from that belief given the state of the economy and the ever increasing foreign influences, but American Made is the foundation of this company and we continue to stand by it.

While striving to provide you with superior products, we also look to the demand in the market place and work to provide you with the most useful and needed products possible. We are not here to simply fill a catalog with parts; we are here to provide you with things that you can use. This year we are excited and proud to introduce a new series of products within our Midnight Series; the Black Stainless Steel Housing Line some of which includes transmission and engine dipsticks, throttle cables, kickdowns and matching mounting brackets. This black stainless steel housing has everyone excited and provides a new option for your vehicle. Please check out these products listed throughout the catalog. We are confident that you will find something that you need, or just can't live without.

As always, thank you to all of our customers, past, present and future, for contributing to the success we have experienced over the many years since our inception. We always appreciate your business, support and patronization. Lokar promises to continue serving you with Quality... Plain & Simple.



## FLOOR SHIFTERS

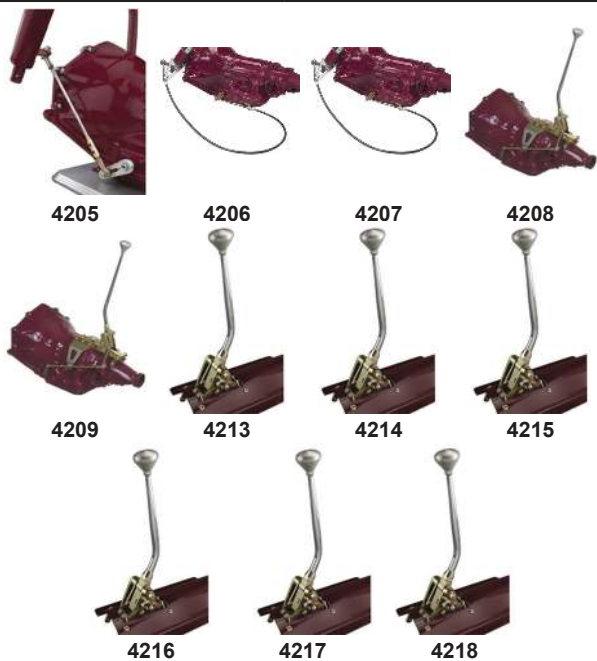

| Part # | Year  | Model           | Part                             | Price      |
|--------|-------|-----------------|----------------------------------|------------|
| 4205   | 58-70 | 350/400/700R4   | Adjustable Shift Linkage         | 69.95 ea.  |
| 4206   | 58-70 | W/2" Column     | Cable Shift Linkage              | 159.95 Kit |
| 4207   | 58-70 | W/2-1/4" Column | Cable Shift Linkage              | 159.95 Kit |
| 4208   | 58-70 | 700R4           | Automatic Transmission Shifter   | 309.95 Kit |
| 4209   | 58-70 | Turbo 350       | Automatic Transmission Shifter   | 299.95 Kit |
| 4213   | 58-70 | Turbo 350       | Floor Mount Shifter              | 299.95 ea. |
| 4214   | 58-70 | Turbo 350       | Floor Mount Shifter (Black Knob) | 299.95 ea. |
| 4215   | 58-70 | Turbo 400       | Floor Mount Shifter              | 279.95 ea. |
| 4216   | 58-70 | Turbo 400       | Floor Mount Shifter (Black Knob) | 279.95 ea. |
| 4217   | 58-70 | 700R4/4L60E     | Floor Mount Shifter              | 279.95 ea. |
| 4218   | 58-70 | 700R4/4L60E     | Floor Mount Shifter (Black Knob) | 279.95 ea. |

## TRANSMISSION DIPSTICKS

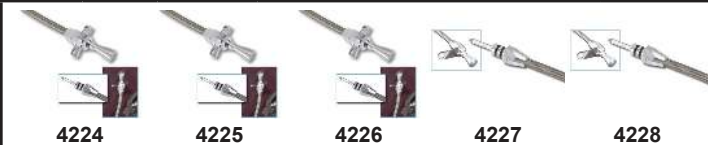

| Part # | Year  | Model         | Part                                     | Price     |
|--------|-------|---------------|--|-----------|
| 4224   | 58-70 | Turbo 350/400 | Firewall Mount Transmission Dipstick     | 119.95 ea |
| 4225   | 58-70 | 4L60E         | Firewall Mount Transmission Dipstick     | 119.95 ea |
| 4226   | 58-70 | 700R4         | Firewall Mount Transmission Dipstick     | 119.95 ea |
| 4227   | 58-70 | Turbo 350     | Transmission Mount Transmission Dipstick | 109.95 ea |
| 4228   | 58-70 | 700R4         | Transmission Mount Transmission Dipstick | 109.95 ea |

## ENGINE DIPSTICKS



| Part # | Year  | Model             | Part                     | Price     |
|--------|-------|-------------------|--------------------------|-----------|
| 4220   | 58-70 | SBC (1979 & Down) | Flexible Engine Dipstick | 79.95 ea. |
| 4221   | 58-70 | SBC (1980 & Up)   | Flexible Engine Dipstick | 79.95 ea. |
| 4222   | 58-70 | Big Block         | Flexible Engine Dipstick | 79.95 ea. |
| 4223   | 58-70 | LS1               | Flexible Engine Dipstick | 79.95 ea. |

## KICK DOWN CABLES



| Part # | Year  | Model     | Part                     | Price      |
|--------|-------|-----------|--------------------------|------------|
| 4229   | 58-70 | Turbo 350 | Kick Down Cable          | 99.95 Ea.  |
| 4230   | 58-70 | Turbo 400 | Electric Kick Down Cable | 119.95 Ea. |
| 4231   | 58-70 | 700R4     | Kick Down Cable          | 99.95 Ea.  |

## THROTTLE CABLES



| Part # | Year  | Model      | Part               | Price     |
|--------|-------|------------|--------------------|-----------|
| 4234   | 58-70 | Carburetor | Throttle Cable 24" | 65.95 Ea. |
| 4235   | 58-70 | Carburetor | Throttle Cable 36" | 79.95 Ea. |
| 4236   | 58-70 | LS1        | Throttle Cable     | 79.95 Ea. |

## THROTTLE/KICK DOWN CABLE BRACKETS



| Part # | Year  | Model                | Part                                  | Price     |
|--------|-------|----------------------|---------------------------------------|-----------|
| 4238   | 58-70 | Carburetor           | Carburetor Bracket /Stainless Springs | 39.95 Set |
| 4232   | 58-70 | Turbo 350            | Kick Down Cable & Bracket             | 59.95 Ea. |
| 4237   | 58-70 | Edelbrock Carburetor | Throttle Cable Bracket & Springs      | 99.95 Set |
| 4659   | 58-70 | w/Holley Sniper EFI  | Throttle/Kick Down Cable Bracket Set  | 89.95 Set |
| 4660   | 58-70 | w/Fitech EFI         | Throttle Cable Bracket Set            | 74.95 Ea. |
| 4661   | 58-70 | w/LS (98-99 Model2)  | Throttle Cable Bracket Set            | 49.95 Ea. |
| 4662   | 58-70 | w/LS (00-02 Models)  | Throttle Cable Bracket Set            | 49.95 Ea. |

## SPEEDOMETER CABLES



| Part # | Year  | Model | Part                            | Price     |
|--------|-------|-------|---------------------------------|-----------|
| 4233   | 58-70 | All   | Universal Speedometer Cable Kit | 99.95 ea. |

# Lokar Products / Manuals

## NEUTRAL SAFETY SWITCHES



| Part # | Year  | Model | Part                               | Price     |
|--------|-------|-------|------------------------------------|-----------|
| 4219   | 58-70 | All   | Backup Light/Neutral Safety Switch | 45.95 ea. |

## PEDALS, PADS & ASSEMBLIES



| Part # | Year  | Model                  | Part   | Price       |
|--------|-------|------------------------|--|-------------|
| 4210   | 58-70 | All                    | Universal Billet Gas Pedal                       | 159.95 Ea.  |
| 4211   | 58-70 | All                    | Universal Floor Mounted Billet Gas Pedal         | 169.95 Ea.  |
| 4212   | 58-70 | All                    | Universal Floor Mounted Billet Gas Pedal (Black) | 169.95 Ea.  |
| 15907  | 58-65 | Automatic Transmission | Billet Brake Pad                                 | 75.95 Ea.   |
| 15908  | 58-65 | Standard Transmission  | Billet Brake/Clutch Pads                         | 119.95 Pair |
| 15909  | 58-65 | Automatic Transmission | Billet Brake Pad Black                           | 75.95 Ea.   |
| 15910  | 58-65 | Standard Transmission  | Billet Brake/Clutch Pads Black                   | 119.95 Pair |

## OWNERS MANUALS



| Part # | Year | Model | Part          | Price     |
|--------|------|-------|---------------|-----------|
| 11297  | 58   | All   | Owners Manual | 10.95 Ea. |
| 11298  | 59   | All   | Owners Manual | 10.95 Ea. |
| 11299  | 60   | All   | Owners Manual | 10.95 Ea. |
| 11300  | 61   | All   | Owners Manual | 10.95 Ea. |
| 11301  | 62   | All   | Owners Manual | 10.95 Ea. |
| 11302  | 63   | All   | Owners Manual | 10.95 Ea. |
| 11303  | 64   | All   | Owners Manual | 10.95 Ea. |
| 11304  | 65   | All   | Owners Manual | 10.95 Ea. |
| 11305  | 66   | All   | Owners Manual | 10.95 Ea. |
| 11306  | 67   | All   | Owners Manual | 10.95 Ea. |
| 11307  | 68   | All   | Owners Manual | 10.95 Ea. |
| 11308  | 69   | All   | Owners Manual | 10.95 Ea. |
| 11309  | 70   | All   | Owners Manual | 10.95 Ea. |

## SHOP MANUALS

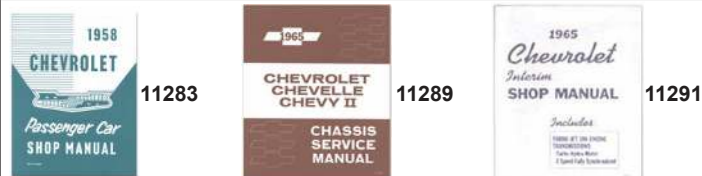

| Part # | Year  | Model | Part                           | Price     |
|--------|-------|-------|--------------------------------|-----------|
| 11283  | 58    | All   | Shop Manual                    | 29.95 Ea. |
| 11284  | 59-60 | All   | Shop Manual (Supplement To 58) | 19.95 Ea. |
| 11285  | 61    | All   | Shop Manual                    | 29.95 Ea. |
| 11286  | 62    | All   | Shop Manual (Supplement To 61) | 19.95 Ea. |
| 11287  | 63    | All   | Shop Manual (Supplement To 61) | 19.95 Ea. |
| 11288  | 64    | All   | Shop Manual (Supplement To 61) | 19.95 Ea. |
| 11289  | 65    | All   | Chassis Service Manual         | 19.95 Ea. |
| 11290  | 65    | All   | Body Service Manual            | 25.95 Ea. |
| 11291  | 65    | All   | High-Performance Supplement    | 19.95 Ea. |
| 11292  | 66    | All   | Shop Manual                    | 25.95 Ea. |
| 11293  | 67    | All   | Shop Manual                    | 25.95 Ea. |
| 11294  | 68    | All   | Shop Manual                    | 25.95 Ea. |
| 11295  | 69    | All   | Shop Manual                    | 25.95 Ea. |
| 11296  | 70    | All   | Shop Manual                    | 24.95 Ea. |

## INSTRUCTIONAL BOOKS



16123

| Part # | Year  | Model       | Part   | Price     |
|--------|-------|-------------|--|-----------|
| 4324   | 58-70 | Small Block | Chevy Small Block Parts Interchange Manual                   | 24.95 Ea. |
| 4325   | 58-70 | Small Block | How To Rebuild A Small Block Chevy                           | 24.95 Ea. |
| 4326   | 58-70 | Small Block | How To Build A Max-Performance Small Block Chevy On A Budget | 24.95 Ea. |
| 4327   | 58-70 | Big Block   | How To Build A Max-Performance Big Block Chevy On A Budget   | 24.95 Ea. |
| 4328   | 58-70 | Ls          | How To Swap An LS Engine Into Almost Anything                | 24.95 Ea. |
| 4329   | 58-70 | Turbo 400   | How To Rebuild & Modify A Turbo 400                          | 24.95 Ea. |
| 4330   | 58-70 | Man Tran    | How To Rebuild & Modify A Manual Tranny                      | 24.95 Ea. |
| 4331   | 58-70 | All         | High Performance Differentials & Drivelines                  | 24.95 Ea. |
| 4349   | 58-70 | Big Block   | Chevy Big Block Parts Interchange Manual                     | 24.95 Ea. |
| 16074  | All   | 348/409     | How To Build & Modify Chevy 348/409                          | 24.95 Ea. |
| 16123  | All   | 302/327     | Muscle Car & Hi Performance Engines Chevy 302 & 327          | 19.95 Ea. |

# Manuals / Mirrors

## FACTORY ASSEMBLY MANUALS



11311



11315



15281

| Part # | Year | Model | Part                    | Price     |
|--------|------|-------|-------------------------|-----------|
| 11310  | 58   | All   | Factory Assembly Manual | 25.95 Ea. |
| 11311  | 59   | All   | Factory Assembly Manual | 25.95 Ea. |
| 11312  | 60   | All   | Factory Assembly Manual | 25.95 Ea. |
| 11313  | 61   | All   | Factory Assembly Manual | 25.95 Ea. |
| 11314  | 62   | All   | Factory Assembly Manual | 24.95 Ea. |
| 15278  | 63   | All   | Factory Assembly Manual | 24.95 Ea. |
| 11315  | 64   | All   | Factory Assembly Manual | 25.95 Ea. |
| 15279  | 65   | All   | Factory Assembly Manual | 24.95 Ea. |
| 15280  | 66   | All   | Factory Assembly Manual | 24.95 Ea. |
| 15281  | 67   | All   | Factory Assembly Manual | 24.95 Ea. |
| 16133  | 68   | All   | Factory Assembly Manual | 25.95 Ea. |
| 16134  | 69   | All   | Factory Assembly Manual | 25.95 Ea. |
| 16135  | 70   | All   | Factory Assembly Manual | 25.95 Ea. |

## WIRING DIAGRAMS



11317



11322



11325

| Part # | Year | Model | Part           | Price    |
|--------|------|-------|----------------|----------|
| 11316  | 58   | All   | Wiring Diagram | 5.00 Ea. |
| 11317  | 59   | All   | Wiring Diagram | 5.00 Ea. |
| 11318  | 60   | All   | Wiring Diagram | 5.00 Ea. |
| 11319  | 61   | All   | Wiring Diagram | 5.00 Ea. |
| 11320  | 62   | All   | Wiring Diagram | 5.00 Ea. |
| 11321  | 63   | All   | Wiring Diagram | 5.00 Ea. |
| 11322  | 64   | All   | Wiring Diagram | 5.00 Ea. |
| 11323  | 65   | All   | Wiring Diagram | 5.00 Ea. |
| 11324  | 66   | All   | Wiring Diagram | 5.00 Ea. |
| 11325  | 67   | All   | Wiring Diagram | 5.00 Ea. |
| 11326  | 68   | All   | Wiring Diagram | 5.00 Ea. |
| 11327  | 69   | All   | Wiring Diagram | 5.00 Ea. |
| 11328  | 70   | All   | Wiring Diagram | 5.00 Ea. |

## OUTSIDE MIRROR GASKETS



11347



11348



11349

| Part # | Year  | Model | Part               | Price    |
|--------|-------|-------|--------------------|----------|
| 11347  | 63-64 | All   | Door Mirror Gasket | 6.95 Ea. |
| 11348  | 65-66 | All   | Door Mirror Gasket | 6.95 Ea. |
| 11349  | 68-70 | All   | Door Mirror Gasket | 4.00 Ea. |

## OUTSIDE MIRRORS



11335



11336



11337



11338



11339



13051



11341



11342



5838

| Part # | Year  | Model | Part              | Price     |
|--------|-------|-------|-------------------|-----------|
| 11335  | 58    | All   | Door Mirror       | 65.95 Ea. |
| 11336  | 59-60 | All   | Door Mirror       | 54.95 Ea. |
| 11337  | 61-62 | All   | Door Mirror       | 50.95 Ea. |
| 11338  | 63-64 | All   | Door Mirror       | 39.95 Ea. |
| 11339  | 65-66 | All   | Door Mirror LH    | 54.95 Ea. |
| 11340  | 65-66 | All   | Door Mirror RH    | 54.95 Ea. |
| 13051  | 67    | All   | Outside Mirror LH | 55.95 Ea. |
| 13052  | 67    | All   | Outside Mirror RH | 55.95 Ea. |
| 11341  | 68    | All   | Door Mirror       | 39.95 Ea. |
| 11342  | 69-70 | All   | Door Mirror LH    | 39.95 Ea. |
| 11343  | 69-70 | All   | Door Mirror RH    | 39.95 Ea. |
| 5838   | 58-70 | All   | 4" Peep Mirror    | 16.95 Ea. |

## OUTSIDE MIRROR MOUNTING KITS



11350



11351



11352



11353



15120

| Part # | Year  | Model | Part                        | Price    |
|--------|-------|-------|-----------------------------|----------|
| 11350  | 58    | All   | Door Mirror Mounting Kit    | 6.95 Kit |
| 11351  | 59-60 | All   | Door Mirror Mounting Kit    | 9.95 Kit |
| 11352  | 61-62 | All   | Door Mirror Mounting Kit    | 9.95 Kit |
| 11353  | 63-64 | All   | Door Mirror Mounting Kit    | 9.95 Kit |
| 15120  | 65-66 | All   | Door Mirror Mounting Kit LH | 7.95 Kit |
| 15121  | 65-66 | All   | Door Mirror Mounting Kit RH | 7.95 Kit |
| 16001  | 68-70 | All   | Door Mirror Mounting Kit    | 5.95 Kit |

## MIRROR PIVOT PLATES



| Part # | Year  | Model | Part                      | Price     |
|--------|-------|-------|---------------------------|-----------|
| 11354  | 64-66 | All   | Remote Mirror Pivot Plate | 42.95 Ea. |

# Mirrors / Motor Mounts

## REAR VIEW MIRROR BRACKETS



| Part # | Year  | Model             | Part                     | Price     |
|--------|-------|-------------------|--------------------------|-----------|
| 12982  | 58    | Hardtop           | Rear View Mirror Bracket | 69.95 Ea. |
| 12983  | 58    | Convertible       | Rear View Mirror Bracket | 79.95 Ea. |
| 11332  | 61-64 | Hardtop           | Rear View Mirror Bracket | 33.95 Ea. |
| 13049  | 61-62 | Convertible       | Rear View Mirror Bracket | 99.95 Ea. |
| 13050  | 63-64 | Convertible       | Rear View Mirror Bracket | 99.95 Ea. |
| 11333  | 65-66 | Hardtop/<br>Sedan | Rear View Mirror Bracket | 54.95 Ea. |
| 15956  | 65-66 | Convertible       | Rear View Mirror Bracket | 89.95 Ea. |

## VANITY MIRRORS



| Part # | Year  | Model | Part          | Price     |
|--------|-------|-------|---------------|-----------|
| 11334  | 58-66 | All   | Vanity Mirror | 45.95 Ea. |

## INSIDE MIRRORS



| Part # | Year  | Model | Part                           | Price     |
|--------|-------|-------|--------------------------------|-----------|
| 11329  | 63-64 | All   | Day/Night Mirror W/Rubber Trim | 45.95 Ea. |
| 5581   | 65-72 | All   | 10" Day/Night Mirror           | 45.95 Ea. |
| 5582   | 58-62 | All   | Rear View Mirror               | 22.95 Ea. |
| 11331  | 63-66 | All   | Rear View Mirror               | 25.95 Ea. |
| 15206  | 69-70 | All   | 12" Day/Night Mirror           | 49.95 Ea. |

## MOTOR MOUNT FRAME BRACKETS



| Part # | Year  | Model      | Part               | Price      |
|--------|-------|------------|--------------------|------------|
| 15146  | 58-62 | 283/327    | Motor Frame Mounts | 50.95 Pair |
| 15147  | 63-64 | 6-Cylinder | Motor Frame Mounts | 32.95 Pair |

## LS1 ENGINE BRACKETS

| Part # | Year  | Model | Part                     | Price       |
|--------|-------|-------|--------------------------|-------------|
| 16222  | 59-64 | w/ LS | Engine To Frame Brackets | 119.95 Pair |
| 16223  | 65-70 | w/ LS | Engine To Frame Brackets | 119.95 Pair |

## LS ENGINE INSTALL KIT



CPP provides everything you need to install a modern, dependable, light-weight, low maintenance, high powered V8. Works with all Vortec and most LS engines. May not work with LSX heads, and dry sump oil systems. Kit includes engine side mount adapters, transmission crossmember, transmission pad, ceramic coated headers, Fit Rite Engine Mount adapters and all the mounting hardware. Note: will not work for LS7 Engines.

| Part # | Year  | Model                    | Part                               | Price      |
|--------|-------|--------------------------|------------------------------------|------------|
| 16220★ | 59-64 | All w/LS<br>(Except LS7) | LS Engine Install Kit<br>(Economy) | 899.95 Kit |
| 16221★ | 65-70 | All w/LS<br>(Except LS7) | LS Engine Install Kit<br>(Economy) | 999.95 Kit |

## MOTOR MOUNT CUSHIONS



| Part # | Year  | Model                             | Part        | Price     |
|--------|-------|-----------------------------------|-------------|-----------|
| 11357  | 66-70 | Belair/Biscayne 250<br>6-Cylinder | Motor Mount | 11.95 Ea. |
| 868    | 58-59 | Impala 283                        | Motor Mount | 8.95 Ea.  |
| 11358  | 60-68 | Impala 283                        | Motor Mount | 8.95 Ea.  |
| 11358  | 66-67 | Caprice 283                       | Motor Mount | 8.95 Ea.  |
| 868    | 68    | Belair/Caprice 307                | Motor Mount | 8.95 Ea.  |
| 11358  | 62-69 | Belair/Biscayne 327               | Motor Mount | 8.95 Ea.  |
| 868    | 63-69 | Impala 327                        | Motor Mount | 8.95 Ea.  |
| 868    | 66-69 | Caprice 327                       | Motor Mount | 8.95 Ea.  |
| 11358  | 58-61 | All w/ 348                        | Motor Mount | 8.95 Ea.  |
| 11359  | 69-70 | All w/ 350                        | Motor Mount | 15.95 Ea. |
| 11360  | 65-67 | All w/ 396                        | Motor Mount | 10.95 Ea. |
| 11359  | 68-69 | All w/ 396                        | Motor Mount | 15.95 Ea. |
| 11359  | 70    | All w/ 400                        | Motor Mount | 15.95 Ea. |
| 11360  | 61-65 | All w/ 400                        | Motor Mount | 10.95 Ea. |
| 11359  | 65-69 | All w/ 427                        | Motor Mount | 15.95 Ea. |
| 11359  | 70    | All w/ 454                        | Motor Mount | 15.95 Ea. |

# Molding

## WINDSHIELD & BACK GLASS MOLDINGS

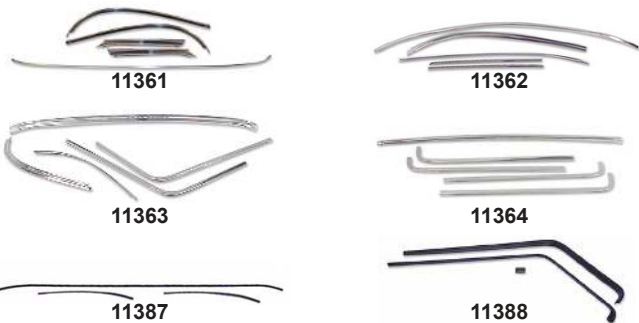

| Part #  | Year  | Model               | Part                       | Price      |
|---------|-------|---------------------|----------------------------|------------|
| 11361   | 63-64 | 2-Dr Hardtop        | Windshield Molding Kit     | 179.95 Kit |
| 11362   | 65-67 | 2-Dr Hardtop        | Windshield Molding Kit     | 169.95 Kit |
| 11363   | 62-64 | 2-Dr Hardtop        | Back Glass Molding Kit     | 189.95 Kit |
| 11364   | 65-66 | 2-Dr Hardtop        | Back Glass Molding Kit     | 145.95 Kit |
| 11387 ① | 63-64 | Belair/<br>Biscayne | Inside Rear Window<br>Trim | 83.95 Set  |
| 11388   | 65-66 | Sedan               | Inside Rear Window<br>Trim | 119.95 Set |

Note: Molding Kits do not come with clips.

## HEADLINER TRIM



| Part #  | Year  | Model          | Part               | Price      |
|---------|-------|----------------|--------------------|------------|
| 15691 ① | 62-64 | Impala Hardtop | Headliner Trim Set | 229.95 Set |

## QUARTER WINDOW MOLDINGS



| Part # | Year | Model | Part                         | Price      |
|--------|------|-------|------------------------------|------------|
| 11475  | 65   | All   | Quarter Window Trim Moldings | 74.95 Pair |

## 1958 IMPALA SIDE MOLDINGS

| Part #  | Year | Model | Part                            | Price         |
|---------|------|-------|---------------------------------|---------------|
| 12946 ② | 58   | 2-Dr  | Upper Door Molding LH           | 85.95 Ea. A   |
| 12947 ② | 58   | 2-Dr  | Upper Door Molding RH           | 85.95 Ea.     |
| 12948 ② | 58   | 2-Dr  | Lower Door Molding LH           | 85.95 Ea. B   |
| 12949 ② | 58   | 2-Dr  | Lower Door Molding RH           | 85.95 Ea.     |
| 12950 ② | 58   | 2-Dr  | Upper Quarter Molding LH        | 85.95 Ea. C   |
| 12951 ② | 58   | 2-Dr  | Upper Quarter Molding RH        | 85.95 Ea.     |
| 12952 ② | 58   | 2-Dr  | Lower Quarter Molding LH        | 85.95 Ea. D   |
| 12953 ② | 58   | 2-Dr  | Lower Quarter Molding RH        | 85.95 Ea.     |
| 12945 ② | 58   | 2-Dr  | Side Aluminum Inserts           | 279.95 Set    |
| 12954   | 58   | 2-Dr  | Rocker Moldings                 | 419.95 Pair E |
| 12984   | 58   | All   | Rear Quarter Louver (8-Per Car) | 15.95 Ea. F   |

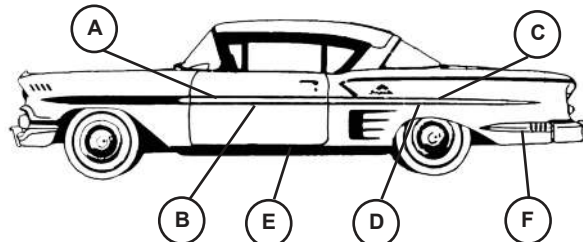

## 1959 IMPALA SIDE MOLDINGS

| Part #  | Year | Model | Part             | Price        |
|---------|------|-------|------------------|--------------|
| 15895 ② | 59   | 2-Dr  | Quarter Moldings | 229.95 Set A |



## 1960 IMPALA/BEL-AIR/BISCAYNE FRONT MOLDINGS

| Part # | Year | Model               | Part                    | Price        |
|--------|------|---------------------|-------------------------|--------------|
| 16071  | 60   | Impala              | Fender Eyebrow Moldings | 199.95 Set A |
| 16072  | 60   | Belair/<br>Biscayne | Fender Eyebrow Moldings | 208.95 Set A |



① = add \$8.95 handling per item  
② = add \$16.95 handling per item

# Molding

## 1960 IMPALA REAR MOLDINGS

| Part #  | Year | Model  | Part          | Price     |   |
|---------|------|--------|---------------|-----------|---|
| 16065 ① | 60   | IMPALA | TRUNK MOLDING | 70.95 Ea. | A |

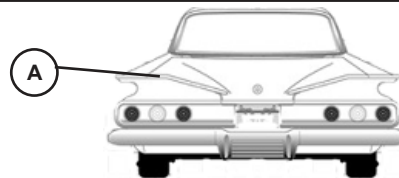

## 1960 IMPALA SIDE MOLDINGS

| Part #  | Year | Model | Part                     | Price       |   |
|---------|------|-------|--------------------------|-------------|---|
| 11390   | 60   | All   | Front Fender Trim Pieces | 209.95 Set  | A |
| 15800   | 60   | All   | Front Fender Moldings    | 129.95 Pair | B |
| 15896 ② | 60   | 2-Dr  | Quarter Moldings         | 145.95 Pair | C |

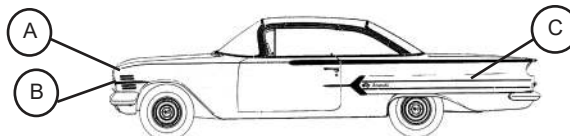

## 1961 IMPALA SIDE MOLDINGS

| Part #  | Year | Model | Part                                    | Price       |   |
|---------|------|-------|---|-------------|---|
| 11392 ② | 61   | 2-Dr  | Front Fender Molding LH/RH              | 69.95 Ea.   | A |
| 13391   | 61   | 2-Dr  | Front Of Door Y-Molding                 | 145.95 Pair | B |
| 11393   | 61   | 2-Dr  | Upper Door Molding LH                   | 29.95 Ea.   | C |
| 11394   | 61   | 2-Dr  | Upper Door Molding RH                   | 29.95 Ea.   |   |
| 15915   | 61   | 2-Dr  | Door Molding Set                        | 135.95 Set  |   |
| 11396 ② | 61   | 2-Dr  | Upper Quarter Molding LH                | 49.95 Ea.   | E |
| 11397 ② | 61   | 2-Dr  | Upper Quarter Molding RH                | 49.95 Ea.   |   |
| 11398 ② | 61   | 2-Dr  | Lower Quarter Molding LH                | 65.95 Ea.   | F |
| 11399 ② | 61   | 2-Dr  | Lower Quarter Molding RH                | 65.95 Ea.   |   |
| 11400   | 61   | 2-Dr  | Quarter Panel Wrap Around Molding LH/RH | 69.95 Pair  | G |
| 13212   | 61   | All   | Quarter Panel Y Molding                 | 54.95 Pair  | H |
| 11402 ② | 61   | 2-Dr  | Complete Side Molding Set               | 544.95 Set  |   |

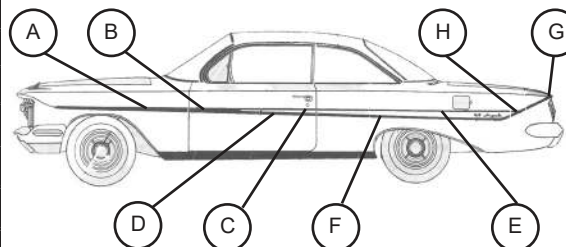

## 1961 IMPALA REAR MOLDINGS

| Part #  | Year | Model  | Part                              | Price       |   |
|---------|------|--------|-----------------------------------|-------------|---|
| 11400 ① | 61   | Impala | Quarter Panel Wrap Around Molding | 69.95 Pair  | A |
| 11401 ① | 61   | Impala | Trunk Lid Moldings                | 134.95 Pair | B |



## 1962 IMPALA & SS SIDE MOLDINGS SETS

These correct reproduction sets include all necessary moldings to replace entire set of moldings for left and right hand sides. SS moldings have tape inserts.

| Part #  | Year | Model     | Part             | Price      |
|---------|------|-----------|------------------|------------|
| 15222 ② | 62   | Impala    | Side Molding Set | 439.95 Set |
| 15223 ② | 62   | Impala SS | Side Molding Set | 439.95 Set |

① = add \$8.95 handling per item

② = add \$16.95 handling per item

# Molding

## 1962 IMPALA SIDE MOLDINGS

| Part # | Year | Model     | Part  | Price       |
|--------|------|-----------|---|-------------|
| 11403① | 62   | All       | Hood Lip Molding  | 169.95 Ea.  |
| 11406① | 62   | Impala    | Upper Trunk Molding                                       | 65.95 Ea.   |
| 11408① | 62   | Impala    | Rear Body Trim Bar  | 299.95 Set  |
| 11407① | 62   | Impala    | Rear Body Grille  | 209.95 Ea.  |
| 11405  | 62   | Impala    | Taillight Cove Moldings                                   | 75.95 Pair  |
| 15165  | 62   | Impala    | Taillight Cove Trim Inserts                               | 319.95 Pair |
| 15164② | 62   | Impala    | Trunk Lid & Taillight Cove Panel Trim Inserts w/ Trim Bar | 799.95 Set  |
| 15166② | 62   | Impala SS | Trunk Lid & Taillight Cove Panel Trim Inserts w/ Trim Bar | 899.95 Set  |
| 11404② | 62   | 2-Dr      | Rocker Panel Moldings                                     | 149.95 Pair |
| 15161  | 62   | Impala SS | Fender Molding Machined Inserts                           | 79.95 Pair  |
| 15162  | 62   | Impala SS | Door Molding Machined Inserts                             | 99.95 Pair  |
| 15163  | 62   | Impala SS | Quarter Panel Mold Machined Inserts                       | 139.95 Pair |
| 15782  | 62   | Hardtop   | Drip Rail Moldings  | 129.95 Pair |

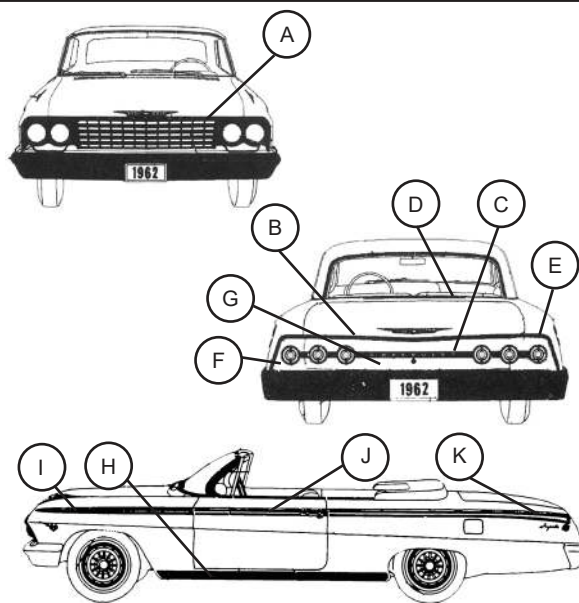

## 1963 IMPALA REAR & FRONT MOLDINGS

| Part # | Year | Model     | Part  | Price      |
|--------|------|-----------|---|------------|
| 11411① | 63   | All       | Hood Lip Molding                              | 199.95 Ea. |
| 13215  | 63   | All       | Upper Fender Eyebrow Moldings                 | 89.95 Pair |
| 11415  | 63   | All       | Lower Fender Eyebrow Moldings                 | 39.95 Pair |
| 11421  | 63   | All       | Outer Cove Moldings                           | 99.95 Pair |
| 13073① | 63   | All       | Upper Trunk Molding                           | 175.95 Ea. |
| 11420① | 63   | All       | Lower Trunk Molding                           | 69.95 Ea.  |
| 15172② | 63   | Impala    | Trunk Lid & Taillight Cove Panel Trim Inserts | 519.95 Set |
| 15173② | 63   | Impala SS | Trunk Lid & Taillight Cove Panel Trim Inserts | 549.95 Set |

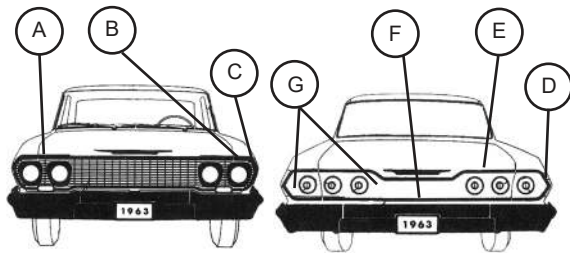

## 1963 IMPALA & SS SIDE MOLDINGS

| Part # | Year | Model     | Part                      | Price       |
|--------|------|-----------|---------------------------|-------------|
| 11414  | 63   | Impala    | Front Fender Trim Pieces  | 59.95 Set   |
| 11416  | 63   | Impala    | Front Fender Moldings     | 79.95 Pair  |
| 13213  | 63   | Impala SS | Front Fender Moldings     | 89.95 Pair  |
| 11417① | 63   | Impala    | Door Moldings             | 149.95 Pair |
| 13214① | 63   | Impala SS | Door Moldings             | 159.95 Pair |
| 11418① | 63   | Impala    | Quarter Panel Moldings    | 209.95 Pair |
| 11419① | 63   | Impala SS | Quarter Panel Moldings    | 229.95 Pair |
| 11423② | 63   | Impala    | Complete Side Molding Set | 359.95 Set  |
| 11424② | 63   | Impala SS | Complete Side Molding Set | 409.95 Set  |
| 15782  | 63   | Hardtop   | Drip Rail Moldings        | 129.95 Pair |

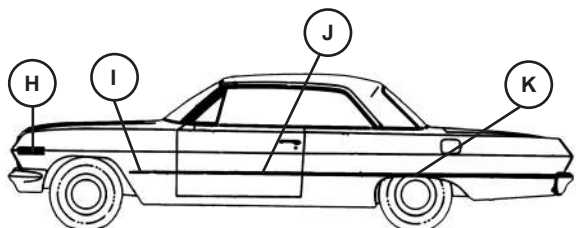

## 1963 ALUMINUM MOLDING TRIM INSERTS

| Part # | Year | Model     | Part   | Price       |
|--------|------|-----------|--|-------------|
| 15169  | 63   | Impala SS | Fender Molding Aluminum Machined Trim Inserts  | 29.95 Pair  |
| 15170  | 63   | Impala SS | Door Molding Aluminum Machined Trim Inserts    | 95.95 Pair  |
| 15171  | 63   | Impala SS | Quarter Molding Aluminum Machined Trim Inserts | 139.95 Pair |

① = add \$8.95 handling per item  
 ② = add \$16.95 handling per item

# Molding

## 1964 IMPALA SS SIDE MOLDINGS

| Part #  | Year | Model     | Part                               | Price       |
|---------|------|-----------|------------------------------------|-------------|
| 11441 ❶ | 64   | Impala SS | Fender Molding                     | 79.95 Ea. A |
| 11442 ❶ | 64   | Impala SS | Door Molding                       | 79.95 Ea. B |
| 11443 ❶ | 64   | Impala SS | Forward Quarter Panel Mold LH      | 79.95 Ea. C |
| 11445 ❶ | 64   | Impala SS | Rear Quarter Panel Molding LH      | 79.95 Ea. D |
| 11446 ❷ | 64   | Impala SS | Quarter Panel Molding RH           | 149.95 Ea.  |
| 11444   | 64   | Impala SS | Gas Door Molding LH                | 35.95 Ea. E |
| 15174   | 64   | Impala SS | Side Molding Machined Inserts Only | 229.95 Set  |
| 11456 ❷ | 64   | Impala SS | Complete Side Molding Set          | 449.95 Set  |

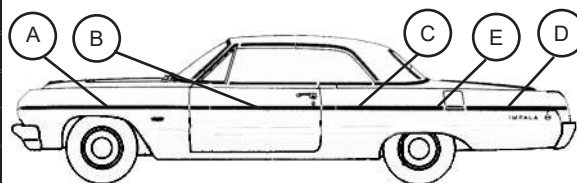

## 1964 REAR AND FRONT MOLDINGS

| Part #  | Year | Model             | Part  | Price        |
|---------|------|-------------------|---|--------------|
| 11427   | 64   | All               | Fender Eyebrow Moldings                       | 99.95 Pair A |
| 11425   | 64   | All               | Hood Lip Molding                              | 209.95 Ea. B |
| 11426 ❶ | 64   | All               | Hood Spear                                    | 85.95 Ea. C  |
| 11128 ❷ | 64   | All               | Lower Grille Molding                          | 69.95 Ea. D  |
| 11439   | 64   | Bel-Air/Impala SS | Outer Cove Moldings                           | 69.95 Pair E |
| 11440   | 64   | Bel-Air/Impala SS | Inner Cove Moldings                           | 35.95 Pair F |
| 11453   | 64   | Impala            | Cove Panel LH                                 | 35.95 Ea. G  |
| 11454   | 64   | Impala            | Cove Panel RH                                 | 35.95 Ea.    |
| 11437 ❶ | 64   | Bel-Air/Impala SS | Upper Trunk Molding                           | 69.95 Ea. H  |
| 11438 ❶ | 64   | Bel-Air/Impala SS | Lower Trunk Molding                           | 69.95 Ea. I  |
| 11448 ❶ | 64   | Impala            | Trunk Lid Edge Molding                        | 119.95 Ea. J |
| 11436 ❶ | 64   | Impala            | Trunk Split Molding                           | 79.95 Ea. K  |
| 15175 ❷ | 64   | Impala SS         | Trunk Lid & Taillight Cove Panel Trim Inserts | 329.95 Set L |

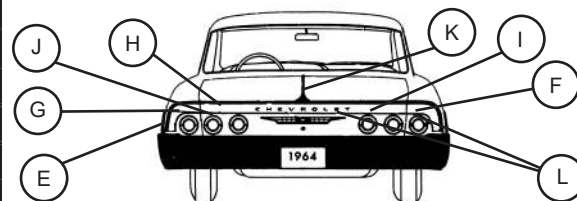
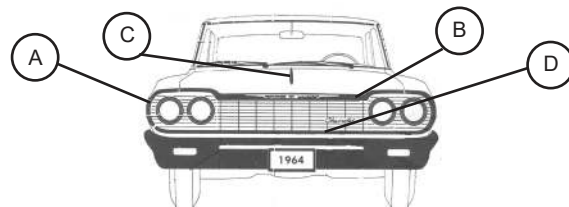

## 1964 IMPALA SIDE MOLDINGS

| Part #  | Year | Model       | Part                           | Price        |
|---------|------|-------------|--------------------------------|--------------|
| 11428 ❶ | 64   | Impala      | Upper Fender Molding           | 69.95 Ea. A  |
| 11429   | 64   | Impala      | Lower Fender Moldings          | 49.95 Pair B |
| 11430 ❶ | 64   | Impala 2-Dr | Upper Door Molding             | 49.95 Ea. C  |
| 13121 ❶ | 64   | Impala 4-Dr | Upper Front Door Molding       | 60.95 Ea.    |
| 11431 ❶ | 64   | Impala 2-Dr | Lower Door Moldings            | 36.95 Ea. D  |
| 11432 ❷ | 64   | Impala 2-Dr | Upper Quarter Panel Molding    | 65.95 Ea. E  |
| 13123 ❷ | 64   | Impala 4-Dr | Upper Quarter Panel Molding    | 46.95 Ea.    |
| 11433 ❷ | 64   | Impala 2-Dr | Lower Quarter Panel Molding LH | 59.95 Ea. F  |
| 11434 ❷ | 64   | Impala 2-Dr | Lower Quarter Panel Molding RH | 59.95 Ea.    |
| 11435   | 64   | Impala      | Quarter Panel C-Moldings       | 79.95 Pair G |
| 15782   | 64   | Hardtop     | Drip Rail Moldings             | 129.95 Pair  |
| 11455 ❷ | 64   | Impala 2-Dr | Complete Side Molding Set      | 449.95 Set   |
| 11457 ❷ | 64   | Impala 4-Dr | Complete Side Molding Set      | 609.95 Set   |

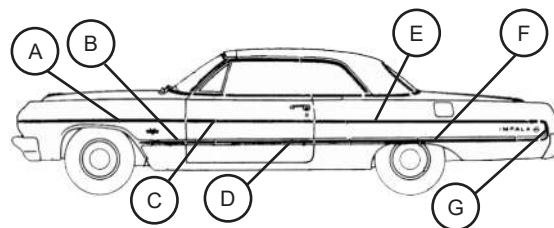

## SIDE TRIM TAPE

Authentic reproduction trim tape with correct patterns! A great product for restoring your original side moldings!

| Part # | Year | Model     | Part                 | Price     |
|--------|------|-----------|----------------------|-----------|
| 11933  | 62   | Impala SS | Side Trim Tape       | 18.95 Kit |
| 11934  | 63   | Impala SS | Side Trim Tape       | 18.95 Kit |
| 11935  | 64   | Impala SS | Side Trim Tape       | 25.95 Kit |
| 11936  | 64   | Impala SS | Tail Panel Trim Tape | 29.95 Kit |



❶ = add \$8.95 handling per item  
 ❷ = add \$16.95 handling per item

# Molding

## 1965 SIDE AND REAR MOLDINGS

| Part #             | Year | Model                         | Part                             | Price       |   |
|--------------------|------|-------------------------------|----------------------------------|-------------|---|
| 11461 <sup>Ⓜ</sup> | 65   | Impala SS                     | Rocker Panel Moldings            | 99.95 Pair  |   |
| 11464              | 65   | All                           | Wheel Well Moldings              | 179.95 Set  | A |
| 11465              | 65   | Impala                        | Rear Body Wrap Around Mold       | 189.95 Pair | B |
| 11471              | 65   | Impala SS (Except Black Cars) | Rear Body Wrap Around Molding LH | 179.95 Ea.  | B |
| 11472              | 65   | Impala SS (Except Black Cars) | Rear Body Wrap Around Molding RH | 179.95 Ea.  | B |
| 11473              | 65   | Impala SS (Black Cars Only)   | Rear Body Wrap Around Molding LH | 179.95 Ea.  | B |
| 11474              | 65   | Impala SS (Black Cars Only)   | Rear Body Wrap Around Molding RH | 179.95 Ea.  | B |
| 11466              | 65   | Impala                        | Rear Body Center Molding         | 219.95 Ea.  | C |
| 11469              | 65   | Impala SS (Except Black Cars) | Rear Body Center Molding         | 319.95 Ea.  | C |
| 11470              | 65   | Impala SS (Black Cars Only)   | Rear Body Center Molding         | 319.95 Ea.  | C |
| 16054              | 65   | Impala/Impala SS              | Trunk Lid Molding                | 105.95 Ea.  |   |

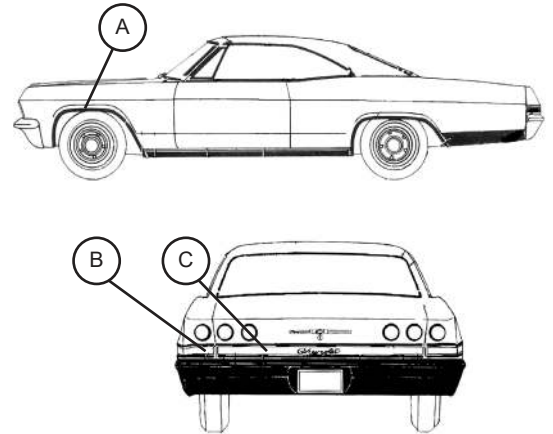

## 1965 FRONT MOLDINGS



11459

11460

| Part # | Year | Model | Part                             | Price     |
|--------|------|-------|----------------------------------|-----------|
| 11459  | 65   | All   | Headlight/Fender Eyebrow Mold LH | 69.95 Ea. |
| 11460  | 65   | All   | Headlight/Fender Eyebrow Mold RH | 69.95 Ea. |

## 1966 REAR AND FRONT MOLDINGS



13138

11476

| Part #             | Year | Model  | Part                    | Price      |
|--------------------|------|--------|-------------------------|------------|
| 13138              | 66   | Impala | Fender Eyebrow Moldings | 55.95 Pair |
| 11476              | 66   | Impala | Hood Split Molding      | 229.95 Ea. |
| 13139 <sup>Ⓜ</sup> | 66   | All    | Trunk Lid Molding       | 135.95 Ea. |

## 1966 SIDE MOLDINGS

| Part #             | Year | Model       | Part                           | Price       |   |
|--------------------|------|-------------|--------------------------------|-------------|---|
| 13124 <sup>Ⓜ</sup> | 66   | Impala      | Fender Molding LH/RH           | 55.95 Ea.   | A |
| 13125 <sup>Ⓜ</sup> | 66   | Impala 2-Dr | Door Molding LH/RH             | 55.95 Ea.   | B |
| 15137 <sup>Ⓜ</sup> | 66   | Impala 4-Dr | Front Door Molding LH/RH       | 69.95 Ea.   |   |
| 15138 <sup>Ⓜ</sup> | 66   | Impala 4-Dr | Rear Door Molding LH/RH        | 69.95 Ea.   |   |
| 15139 <sup>Ⓜ</sup> | 66   | Impala 4-Dr | Quarter Panel Moldings         | 129.95 Pair |   |
| 13127              | 66   | Impala      | Quarter Panel Wrap Around Mold | 65.95 Pair  | D |
| 11478              | 66   | All         | Wheel Well Moldings            | 179.95 Set  | E |
| 11477 <sup>Ⓜ</sup> | 66   | Impala 2-Dr | Complete Side Molding Set      | 239.95 Set  |   |
| 15136 <sup>Ⓜ</sup> | 66   | Impala 4-Dr | Complete Side Molding Set      | 329.95 Set  |   |
| 15938              | 66   | Impala      | Fender Extension Moldings      | 60.95 Pair  |   |

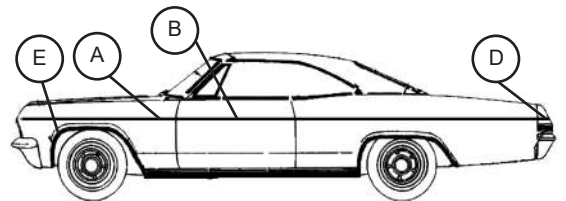

<sup>Ⓜ</sup> = add \$8.95 handling per item  
<sup>Ⓜ</sup> = add \$16.95 handling per item

# Molding / Oil System / Power Steering / Power Steering

## 1967-70 IMPALA SIDE MOLDINGS



| Part # | Year  | Model       | Part   | Price       |
|--------|-------|-------------|--|-------------|
| 15289  | 67    | All         | Upper Fender Eyebrow Mold  | 149.95 Pair |
| 13044  | 68    | Impala      | Complete Side Molding Set  | 419.95 Set  |
| 12852  | 67    | All         | Wheel Well Moldings  | 179.95 Set  |
| 12853  | 68    | All         | Wheel Well Moldings  | 179.95 Set  |
| 15805  | 69    | 2-Dr        | Wheel Well Moldings  | 179.95 Set  |
| 14982  | 70    | All         | Wheel Well Moldings  | 179.95 Set  |
| 11463  | 68-69 | All         | Rocker Moldings<br>(Requires 12 Clips To Complete Installation Part #5088) | 99.95 Pair  |
| 15898  | 67    | Impala 2-Dr | Trunk Molding  | 399.95 Ea   |

## OIL DIPSTICK TUBES



| Part # | Year  | Model          | Part              | Price     |
|--------|-------|----------------|-------------------|-----------|
| 11497  | 59-64 | 283/327        | Oil Dipstick Tube | 7.95 Ea.  |
| 11498  | 58-64 | 6-Cylinder     | Oil Dipstick Tube | 3.50 Ea.  |
| 11500  | 68-69 | 396/427        | Oil Dipstick Tube | 29.95 Ea. |
| 1439   | 58-65 | All Non-409 V8 | Oil Filler Tube   | 38.95 Ea. |

## OIL CAPS



| Part # | Year  | Model     | Part                     | Price    |
|--------|-------|-----------|--------------------------|----------|
| 853    | 58-66 | All       | Oil Filler Cap           | 29.95 Ea |
| 16315  | 65-69 | w/396/427 | Oil Cap "S" Style        | 15.95 Ea |
| 16316  | 65-69 | w/396/427 | Chrome Oil Cap "S" Style | 19.95 Ea |

## RAG JOINTS



| Part # | Year  | Model         | Part      | Price     |
|--------|-------|---------------|-----------|-----------|
| 13028  | 58-64 | All w/500 Box | Rag Joint | 65.95 Ea. |

## OIL DIPSTICKS



| Part # | Year  | Model      | Part         | Price    |
|--------|-------|------------|--------------|----------|
| 11494  | 66-69 | 6-Cylinder | Oil Dipstick | 9.95 Ea. |

## OIL PRESSURE SENDING UNITS



| Part # | Year  | Model | Part                      | Price     |
|--------|-------|-------|---------------------------|-----------|
| 2247   | 58-69 | All   | Oil Pressure Sending Unit | 14.95 Ea. |

## POWER STEERING SLAVE CYLINDER



| Part # | Year  | Model | Part                          | Price      |
|--------|-------|-------|-------------------------------|------------|
| 11537  | 58-64 | All   | Power Steering Slave Cylinder | 139.95 Ea. |

## POWER STEERING CONTROL VALVE



| Part # | Year  | Model | Part                         | Price      |
|--------|-------|-------|------------------------------|------------|
| 11536  | 58-64 | All   | Power Steering Control Valve | 249.95 Ea. |

## POWER STEERING PUMP BRACKETS



| Part # | Year  | Model                    | Part                                     | Price      |
|--------|-------|--------------------------|--|------------|
| 1701   | 58-64 | Small Block              | Power Steering Pump Bracket              | 69.95 Ea.  |
| 2085   | 58-64 | Big Block Non 348 or 409 | Power Steering Pump Bracket              | 69.95 Ea.  |
| 1711   | 58-64 | All                      | Power Steering Pump w/Dual Groove Pulley | 165.95 Ea. |

## 500 POWER STEERING BOX & HOSES



Our 500 power steering box is unlike your average 605 box. Instead of using old parts from a 58-64 steering box and using the remainder of the lower housing from a manual steering box, we have cast a new Pitman shaft with the correct number of teeth already in the right position and a new lower housing with the bracket made into the housing. Once you see your 500 box, you will decide that this is the best box on the market today.

| Part # | Year  | Model | Part  | Price     |
|--------|-------|-------|---|-----------|
| 12795  | 58-64 | All   | 500 Power Steering Box<br>(On 1959-1963 Models You Will Have To Modify Your Radiator Or Purchase Part# 16124 Aluminum Radiator w/ A Notch That Allows For Room Over The Top Of This Steering Gear.) | 409.95 Ea |
| 1565   | 58-64 | All   | Hose Kit For #12795   | 55.95 Ea  |
| 1711   | 58-64 | All   | Power Steering Pump w/Dual Groove Pulley  | 165.95 Ea |

# Power Steering / Radiators

## POWER STEERING HOSES



| Part# | Year  | Model      | Part   | Price      |
|-------|-------|------------|--|------------|
| 11533 | 58-59 | All        | Power Steering Hose Set                        | 109.95 Set |
| 11534 | 60-64 | All        | Power Steering Hose Set                        | 119.95 Set |
| 11535 | 60-64 | All        | Power Steering Line From Pump To Pressure Hose | 13.95 Ea.  |
| 12718 | 65-70 | 6-Cylinder | Power Steering Pressure Hose                   | 45.95 Ea.  |
| 12719 | 65-67 | 283/327    | Power Steering Pressure Hose                   | 42.95 Ea.  |
| 12720 | 68    | 307/327    | Power Steering Pressure Hose                   | 40.95 Ea.  |
| 12721 | 69-70 | V8         | Power Steering Pressure Hose                   | 56.95 Ea.  |
| 12723 | 67-70 | All        | Power Steering Return Hose                     | 39.95 Ea.  |

## POWER STEERING CONVERSION KIT



Each of our 500 power steering kits comes with the 500 gear itself, power steering pump with dual groove pulley, hose kit, and pump bracket. It does not come with a steering column. For steering columns, you will have to convert your original, buy an Ildit tilt column, or convert some other column to work. For automatic column shifts or floor shifts.

| Part# | Year  | Model          | Part   | Price      |
|-------|-------|----------------|--|------------|
| 12457 | 58-64 | Small Block V8 | 500 Ps Conversion Kit  | 593.95 Kit |
| 12458 | 58-64 | Big Block V8   | 500 Ps Conversion Kit (Will not work on 348 & 409, when using on 1959 to 1963 you must purchase a #16124 (pg. 79) radiator to work w/ this or notch your radiator to work around the steering box. The 500 box is bigger than the standard box and must have a modified radiator to work.) | 593.95 Kit |

## POWER STEERING HOSE RETAINER



| Part# | Year | Model | Part                         | Price     |
|-------|------|-------|------------------------------|-----------|
| 12974 | 58   | All   | Power Steering Hose Retainer | 25.95 Ea. |

## HOSE CLAMPS



| Part# | Year  | Model | Part                           | Price     |
|-------|-------|-------|--------------------------------|-----------|
| 11570 | 58-74 | All   | Upper Radiator Hose Clamp      | 2.50 Ea.  |
| 11571 | 58-74 | All   | Lower Radiator Hose Clamp      | 2.50 Ea.  |
| 11572 | 58    | All   | Radiator/Heater Hose Clamp Set | 15.95 Set |
| 11573 | 59-72 | All   | Radiator/Heater Hose Clamp Set | 29.95 Set |

## RADIATOR PETCOCKS



| Part# | Year  | Model | Part                     | Price    |
|-------|-------|-------|--------------------------|----------|
| 1334  | 55-66 | All   | Radiator Petcocks w/Hose | 8.95 Ea. |
| 11576 | 67-72 | All   | Radiator Petcocks w/Hose | 8.95 Ea. |

## RADIATOR CAPS



| Part# | Year  | Model | Part         | Price     |
|-------|-------|-------|--------------|-----------|
| 653   | 58-64 | All   | Radiator Cap | 13.95 Ea. |
| 8471  | 65-70 | All   | Radiator Cap | 29.95 Ea. |

## RADIATOR BUG SCREEN



| Part# | Year | Model | Part                | Price     |
|-------|------|-------|---------------------|-----------|
| 15635 | 58   | All   | Radiator Bug Screen | 30.95 Ea. |

## BY-PASS HOSES



| Part# | Year  | Model           | Part         | Price     |
|-------|-------|-----------------|--------------|-----------|
| 11568 | 58-64 | 348/409         | By-Pass Hose | 14.95 Ea. |
| 11569 | 58-61 | 348 3X2-Barrell | By-Pass Hose | 30.95 Ea. |

## LOWER RADIATOR HOSES



| Part# | Year  | Model            | Part                | Price     |
|-------|-------|------------------|---------------------|-----------|
| 11555 | 58    | 6-Cylinder       | Lower Radiator Hose | 30.95 Ea. |
| 11556 | 59-62 | 6-Cylinder       | Lower Radiator Hose | 30.95 Ea. |
| 11557 | 63-64 | 6-Cylinder       | Lower Radiator Hose | 30.95 Ea. |
| 11558 | 58    | 283              | Lower Radiator Hose | 21.95 Ea. |
| 11559 | 59-64 | 283              | Lower Radiator Hose | 21.95 Ea. |
| 11559 | 62-64 | 327 Except Hi-Po | Lower Radiator Hose | 21.95 Ea. |
| 11560 | 62-64 | 283/327 w/AC     | Lower Radiator Hose | 30.95 Ea. |
| 11561 | 65    | 283/327          | Lower Radiator Hose | 21.95 Ea. |
| 11561 | 66-68 | 283/327/350      | Lower Radiator Hose | 21.95 Ea. |
| 11562 | 66-68 | 327/350 w/o AC   | Lower Radiator Hose | 21.95 Ea. |
| 11563 | 69    | 327/350          | Lower Radiator Hose | 21.95 Ea. |
| 15659 | 69-70 | 327/350 w/AC     | Lower Radiator Hose | 21.95 Ea. |
| 11564 | 58    | 348              | Lower Radiator Hose | 30.95 Ea. |
| 11565 | 59-64 | 348/409          | Lower Radiator Hose | 21.95 Ea. |
| 11566 | 65    | 396              | Lower Radiator Hose | 21.95 Ea. |
| 11567 | 66-69 | 396/427 w/AC     | Lower Radiator Hose | 21.95 Ea. |
| 15661 | 69    | 396/427 w/o AC   | Lower Radiator Hose | 21.95 Ea. |
| 15662 | 70    | 454              | Lower Radiator Hose | 21.95 Ea. |

# Radiators

## UPPER RADIATOR HOSES



| Part# | Year  | Model                             | Part                | Price     |
|-------|-------|-----------------------------------|---------------------|-----------|
| 11538 | 59-60 | 6-Cylinder                        | Upper Radiator Hose | 35.95 Ea. |
| 11539 | 62    | 6-Cylinder                        | Upper Radiator Hose | 30.95 Ea. |
| 11540 | 63-64 | 6-Cylinder                        | Upper Radiator Hose | 30.95 Ea. |
| 11541 | 58    | 283                               | Upper Radiator Hose | 21.95 Ea. |
| 11542 | 59-62 | 283/327 Except Fuel Injection     | Upper Radiator Hose | 21.95 Ea. |
| 11542 | 63-64 | 283/327                           | Upper Radiator Hose | 21.95 Ea. |
| 15657 | 63-64 | 327 w/AC                          | Upper Radiator Hose | 21.95 Ea. |
| 11543 | 65    | 283/327                           | Upper Radiator Hose | 21.95 Ea. |
| 11544 | 66-68 | 283                               | Upper Radiator Hose | 19.95 Ea. |
| 11544 | 66-68 | 327/350 w/o AC                    | Upper Radiator Hose | 19.95 Ea. |
| 11545 | 66-68 | 327/350 w/AC                      | Upper Radiator Hose | 19.95 Ea. |
| 15658 | 69-70 | Small Block                       | Upper Radiator Hose | 20.95 Ea. |
| 11546 | 58    | 348 4-Barrel                      | Upper Radiator Hose | 30.95 Ea. |
| 11547 | 58    | 348 3X2-Barrel                    | Upper Radiator Hose | 30.95 Ea. |
| 11542 | 59-61 | 348 4-Barrel Except HD Rad & w/AC | Upper Radiator Hose | 21.95 Ea. |
| 11548 | 59-61 | 348 2X4-Barrel                    | Upper Radiator Hose | 30.95 Ea. |
| 11549 | 60-61 | 348 Except 3X2-Barrel             | Upper Radiator Hose | 21.95 Ea. |
| 11550 | 59-61 | 348 3X2-Barrell                   | Upper Radiator Hose | 30.95 Ea. |
| 11551 | 65    | 396 Air Hi-Po                     | Upper Radiator Hose | 19.95 Ea. |
| 11552 | 65    | 396 325HP                         | Upper Radiator Hose | 21.95 Ea. |
| 11553 | 66-68 | 396/427 w/AC                      | Upper Radiator Hose | 30.95 Ea. |
| 11554 | 66-68 | 396/427 w/o AC                    | Upper Radiator Hose | 21.95 Ea. |
| 11554 | 69    | 396/427                           | Upper Radiator Hose | 21.95 Ea. |
| 11549 | 61-64 | 409 w/o AC                        | Upper Radiator Hose | 21.95 Ea. |
| 15660 | 70    | 454                               | Upper Radiator Hose | 21.95 Ea. |

## RADIATOR CORE SUPPORTS



| Part# | Year | Model | Part                  | Price      |
|-------|------|-------|-----------------------|------------|
| 15940 | 62   | All   | Radiator Core Support | 209.95 Ea. |
| 13164 | 63   | All   | Radiator Core Support | 199.95 Ea. |
| 12870 | 64   | All   | Radiator Core Support | 199.95 Ea. |
| 11214 | 65   | All   | Radiator Core Support | 259.95 Ea. |
| 16138 | 66   | All   | Radiator Core Support | 219.95 Ea. |

## RADIATOR OVERFLOW TANKS



| Part# | Year  | Model | Part                           | Price     |
|-------|-------|-------|--------------------------------|-----------|
| 4169  | 58-70 | All   | Universal SS 13" Overflow Tank | 55.95 Ea. |
| 4170  | 58-70 | All   | Universal SS 15" Overflow Tank | 55.95 Ea. |

## RADIATOR CORE SUPPORT MOUNTS



| Part# | Year  | Model | Part  | Price     |
|-------|-------|-------|---|-----------|
| 6479  | 58-60 | All   | Radiator Core Support Mounts  | 27.95 Kit |
| 5589  | 61-64 | All   | Core Support Rubber Frame Pads  | 8.95 Set  |
| 15682 | 60-64 | All   | Radiator Core Support Mount Hardware (This Item Is To Be Used w/ Part #5589.) | 13.95 Kit |
| 11574 | 65    | All   | Radiator Core Support Mounts  | 39.95 Kit |
| 11575 | 66-68 | All   | Radiator Core Support Mounts  | 49.95 Kit |

## ALUMINUM RADIATORS



| Part# | Year  | Model                             | Part  | Price      |
|-------|-------|-----------------------------------|---|------------|
| 16125 | 58    | All                               | Aluminum Radiator                           | 399.95 Ea. |
| 16124 | 59-63 | All w/ 500 Power Steering         | Aluminum Radiator                           | 399.95 Ea. |
| 15710 | 61-63 | Automatic                         | Aluminum Radiator                           | 399.95 Ea. |
| 15711 | 64    | Automatic                         | Aluminum Radiator                           | 399.95 Ea. |
| 15712 | 65    | Automatic                         | Aluminum Radiator                           | 399.95 Ea. |
| 15713 | 66-68 | Automatic                         | Aluminum Radiator                           | 399.95 Ea. |
| 16288 | 58    | All                               | Aluminum Radiator w/Shroud And Electric Fan | 575.95 Ea  |
| 16289 | 59-63 | All Except w/500/605 Steering Box | Aluminum Radiator w/Shroud And Electric Fan | 575.95 Ea. |
| 16578 | 64    | All                               | Radiator With Electric Fan Kit              | 575.95 Kit |
| 16295 | 65-70 | All                               | Aluminum Radiator w/Shroud And Electric Fan | 575.95 Ea  |
| 16296 | 59-70 | All w/LS Motor                    | Aluminum Radiator w/Shroud And Electric Fan | 575.95 Ea. |

All radiators in this catalog are replacements. Tanks are not embossed with numbers.

★ = special order non-stocking item, please allow 4-6 weeks for delivery.  
 Ⓜ = add \$16.95 handling per item

## RADIATORS

### HOW TO MEASURE A RADIATOR

Measure only the core in order to determine the size of the radiator. Always measure the height with the tubes (direction of the coolant flow). To determine width, measure the core only. Do not include the side channels or mounting brackets. To measure core thickness, use a small diameter wire and insert it through the core until the end is flush with the other side. Hold the wire flush to the core with your thumb and forefinger, remove wire, and measure it. The length of the wire from your thumb and forefinger to the end will equal the thickness.



| Part #  | Year  | Model                | Part  | Price      |
|---|-------|----------------------|---|------------|
| When ordering radiators, please make sure to verify what motor, transmission, and core size that your car came from the factory with. |       |                      |   |            |
| 11577   | 58    | 6-Cylinder Automatic | Heavy Duty Radiator 3-Core                              | 529.95 Ea. |
| 11578   | 58    | 283 Automatic        | Heavy Duty Radiator 3-Core                              | 529.95 Ea. |
| 11579   | 58    | 348 Automatic        | Heavy Duty Radiator 3-Core                              | 529.95 Ea. |
| 11580   | 58    | 6-Cylinder Standard  | Heavy Duty Radiator 3-Core                              | 529.95 Ea. |
| 11581   | 58    | 283 Standard         | Heavy Duty Radiator 3-Core                              | 529.95 Ea. |
| 11582   | 58    | 348 Standard         | Heavy Duty Radiator 3-Core                              | 529.95 Ea. |
| 11583   | 59-60 | 6-Cylinder Automatic | Heavy Duty Radiator 3-Core                              | 548.95 Ea. |
| 11584   | 59-60 | 283 Automatic        | Desert Cooler Radiator 4-Core                           | 548.95 Ea. |
| 11585   | 59-60 | 348 Automatic        | Desert Cooler Radiator 4-Core                           | 548.95 Ea. |
| 11586   | 59-60 | 6-Cylinder Standard  | Heavy Duty Radiator 3-Core                              | 548.95 Ea. |
| 11587   | 59-60 | 283 Standard         | Desert Cooler Radiator 4-Core                           | 548.95 Ea. |
| 11588   | 59-60 | 348 Standard         | Desert Cooler Radiator 4-Core                           | 548.95 Ea. |
| 11589   | 61-62 | 6-Cylinder Automatic | Heavy Duty Radiator 3-Core                              | 499.95 Ea. |
| 11597   | 63    | 6-Cylinder Automatic | Heavy Duty Radiator 3-Core                              | 499.95 Ea. |
| 11590   | 61-63 | 283 Automatic        | Desert Cooler Radiator 4-Core (15 1/2 X 23 1/2 X 1 1/4) | 499.95 Ea. |
| 11591   | 61-63 | 283 Automatic        | Desert Cooler Radiator 4-Core (17 1/2 X 25 1/2 X 2)     | 499.95 Ea. |
| 11592   | 61-63 | 409 Automatic        | Desert Cooler Radiator 4-Core                           | 499.95 Ea. |
| 11593   | 61-62 | 6-Cylinder Standard  | Heavy Duty Radiator 3-Core                              | 499.95 Ea. |
| 11598   | 63    | 6-Cylinder Standard  | Heavy Duty Radiator 3-Core                              | 499.95 Ea. |
| 11594   | 61-63 | 283 Standard         | Desert Cooler Radiator 4-Core (15 1/2 X 23 1/2 X 1 1/4) | 499.95 Ea. |
| 11595   | 61-63 | 283 Standard         | Desert Cooler Radiator 4-Core (17 1/2 X 25 1/2 X 2)     | 499.95 Ea. |
| 11596   | 61-63 | 409 Standard         | Desert Cooler Radiator 4-Core                           | 499.95 Ea. |
| 11599   | 64-65 | 6-Cylinder Automatic | Heavy Duty Radiator 3-Core                              | 499.95 Ea. |
| 11600   | 64    | 283/327 Automatic    | Desert Cooler Radiator 4-Core (15 1/2 X 23 1/2 X 1 1/4) | 499.95 Ea. |
| 11601   | 64    | 283/327 Automatic    | Desert Cooler Radiator 4-Core (17 1/2 X 25 1/2 X 2)     | 499.95 Ea. |
| 11602   | 64    | 409 Automatic w/AC   | Desert Cooler Radiator 4-Core                           | 558.95 Ea. |
| 11603   | 64    | 409 Automatic w/o AC | Desert Cooler Radiator 4-Core                           | 499.95 Ea. |
| 11604   | 64-65 | 6-Cylinder Standard  | Desert Cooler Radiator 4-Core                           | 499.95 Ea. |
| 11605   | 64    | 283/327 Standard     | Desert Cooler Radiator 4-Core (15 1/2 X 23 1/2 X 1 1/4) | 499.95 Ea. |
| 11606   | 64    | 283/327 Standard     | Desert Cooler Radiator 4-Core (17 1/2 X 25 1/2 X 2)     | 499.95 Ea. |
| 11607   | 64    | 409 Standard w/AC    | Desert Cooler Radiator 4-Core                           | 558.95 Ea. |
| 11608   | 64    | 409 Standard w/o AC  | Desert Cooler Radiator 4-Core                           | 499.95 Ea. |
| 11609   | 65    | 283/327 Automatic    | Desert Cooler Radiator 4-Core (15 1/2 X 23 1/2 X 1 1/4) | 499.95 Ea. |
| 11610   | 65    | 283/327 Automatic    | Desert Cooler Radiator 4-Core (17 1/2 X 25 1/2 X 2)     | 499.95 Ea. |
| 11611   | 65    | 396/409 Automatic    | Desert Cooler Radiator 4-Core (17 1/2 X 25 1/2 X 2)     | 499.95 Ea. |
| 11612   | 65    | 396/409 Automatic    | Desert Cooler Radiator 4-Core (17 1/2 X 25 1/2 X 2 5/8) | 558.95 Ea. |
| 11613   | 65    | 283/327 Standard     | Desert Cooler Radiator 4-Core (15 1/2 X 23 1/2 X 1 1/4) | 499.95 Ea. |

★ = special order non-stocking item, please allow 4-6 weeks for delivery.  
 ● = add \$16.95 handling per item

All radiators in this catalog are replacements.  
 Tanks are not embossed with numbers.

## RADIATORS

|       |       |                                     |   |            |
|-------|-------|-------------------------------------|---|------------|
| 11614 | 65    | 283/327 Standard                    | Desert Cooler Radiator 4-Core (17 1/2 X 25 1/2 X 2)     | 499.95 Ea. |
| 11615 | 65    | 396/409 Standard                    | Desert Cooler Radiator 4-Core (17 1/2 X 25 1/2 X 2)     | 499.95 Ea. |
| 11616 | 65    | 396/409 Standard                    | Desert Cooler Radiator 4-Core (17 1/2 X 25 1/2 X 2 5/8) | 558.95 Ea. |
| 11617 | 66-67 | 6-Cylinder Automatic                | Heavy Duty Radiator 3-Core                              | 499.95 Ea. |
| 11618 | 66    | 283/327 Automatic                   | Desert Cooler Radiator 4-Core (15 1/2 X 23 1/2 X 1 1/4) | 499.95 Ea. |
| 11619 | 66    | 283/327 Automatic                   | Desert Cooler Radiator 4-Core (17 1/2 X 25 1/2 X 2)     | 499.95 Ea. |
| 11620 | 66    | 396 Automatic                       | Desert Cooler Radiator 4-Core                           | 519.95 Ea. |
| 11621 | 66-67 | 6-Cylinder Standard                 | Heavy Duty Radiator 3-Core                              | 499.95 Ea. |
| 11622 | 66    | 283/327 Standard                    | Desert Cooler Radiator 4-Core (15 1/2 X 23 1/2 X 1 1/4) | 499.95 Ea. |
| 11623 | 66    | 283/327 Standard                    | Desert Cooler Radiator 4-Core (17 1/2 X 25 1/2 X 2)     | 499.95 Ea. |
| 11624 | 66    | 396 Standard                        | Desert Cooler Radiator 4-Core                           | 519.95 Ea. |
| 11625 | 67    | 283/327 Automatic                   | Desert Cooler Radiator 4-Core (15 1/2 X 23 1/2 X 1 1/4) | 499.95 Ea. |
| 11626 | 67    | 283/327 Automatic                   | Desert Cooler Radiator 4-Core (17 1/2 X 25 1/2 X 2)     | 499.95 Ea. |
| 11627 | 67    | 396/427 Automatic                   | Desert Cooler Radiator 4-Core                           | 519.95 Ea. |
| 11628 | 67    | 283/327 Standard                    | Desert Cooler Radiator 4-Core (15 1/2 X 23 1/2 X 1 1/4) | 499.95 Ea. |
| 11629 | 67    | 283/327 Standard                    | Desert Cooler Radiator 4-Core (17 1/2 X 25 1/2 X 2)     | 499.95 Ea. |
| 11630 | 67    | 396/427 Standard                    | Desert Cooler Radiator 4-Core                           | 519.95 Ea. |
| 11631 | 68    | 6-Cylinder Automatic                | Heavy Duty Radiator 3-Core                              | 499.95 Ea. |
| 11632 | 68    | Small Block V8 Automatic            | Desert Cooler Radiator 4-Core (17 1/2 X 23 1/2 X 1 1/4) | 499.95 Ea. |
| 11633 | 68    | Small Block V8 Automatic            | Desert Cooler Radiator 4-Core (17 1/2 X 23 1/2 X 2)     | 499.95 Ea. |
| 11634 | 68    | 396/427 Automatic                   | Desert Cooler Radiator 4-Core                           | 499.95 Ea. |
| 11635 | 68    | 6-Cylinder Standard                 | Heavy Duty Radiator 3-Core                              | 499.95 Ea. |
| 11636 | 68    | Small Block V8 Standard             | Desert Cooler Radiator 4-Core (17 1/2 X 23 1/2 X 1 1/4) | 499.95 Ea. |
| 11637 | 68    | Small Block V8 Standard             | Desert Cooler Radiator 4-Core (17 1/2 X 23 1/2 X 2)     | 499.95 Ea. |
| 11638 | 68    | 396/427 Standard                    | Desert Cooler Radiator 4-Core                           | 499.95 Ea. |
| 11639 | 69-70 | 6-Cylinder/Small Block V8 Automatic | Desert Cooler Radiator 4-Core (15 1/2 X 23 1/2 X 1 1/4) | 499.95 Ea. |
| 11640 | 69-70 | 6-Cylinder/Small Block V8 Automatic | Desert Cooler Radiator 4-Core (17 1/2 X 25 1/2 X 2)     | 499.95 Ea. |
| 11641 | 69-70 | 396/427/454 Automatic               | Desert Cooler Radiator 4-Core                           | 499.95 Ea. |
| 11642 | 69-70 | 6-Cylinder/Small Block V8 Standard  | Desert Cooler Radiator 4-Core (15 1/2 X 23 1/2 X 1 1/4) | 499.95 Ea. |
| 11643 | 69-70 | 6-Cylinder/Small Block V8 Standard  | Desert Cooler Radiator 4-Core (17 1/2 X 25 1/2 X 2)     | 499.95 Ea. |
| 11644 | 69-70 | 396/427/454 Standard                | Desert Cooler Radiator 4-Core                           | 499.95 Ea. |

★ = special order non-stocking item, please allow 4-6 weeks for delivery.  
 ② = add \$16.95 handling per item

All radiators in this catalog are replacements.  
 Tanks are not embossed with numbers.

# Fan Shrouds / Electric Fans / Speakers

## FAN SHROUDS



Small Block



Big Block

| Part #             | Year  | Model       | Part             | Price      |
|--------------------|-------|-------------|------------------|------------|
| 15616 <sup>e</sup> | 59-63 | Small Block | Fan Shroud       | 139.95 Ea. |
| 15617 <sup>e</sup> | 64    | Small Block | Fan Shroud       | 139.95 Ea. |
| 16127 <sup>e</sup> | 65-66 | Small Block | Steel Fan Shroud | 159.95 Ea. |
| 16008 <sup>e</sup> | 66-67 | Big Block   | Fan Shroud       | 155.95 Ea. |

## ELECTRIC FANS & PARTS



| Part # | Model                | Part  | Price      |
|--------|----------------------|---|------------|
| 3782   | All                  | 14" Puller Electric Fan 1720 CFM              | 179.95 ea. |
| 3783   | All                  | 14" Pusher Electric Fan 1720 CFM              | 179.95 ea. |
| 3784   | All                  | 16" Puller Electric Fan 2360 CFM              | 179.95 ea. |
| 3785   | All                  | 16" Pusher Electric Fan 2360 CFM              | 179.95 ea. |
| 3786   | All                  | 16" Extreme Duty Puller Electric Fan 3000 CFM | 309.95 ea. |
| 3743   | All                  | Trinary Switch Kit                            | 65.95 Kit  |
| 3744   | All                  | Single Electric Fan Relay Kit                 | 80.95 Kit  |
| 4596   | w/Dual Electric Fans | Dual Fan Relay Kit                            | 89.95 Kit  |
| 3745   | All                  | Adjustable Fan Thermostat                     | 45.95 ea.  |
| 3854   | All                  | Fan Mounting Kit (4 Required per Fan)         | 9.95 ea.   |
| 4320   | All                  | 16" Fan Shroud Gasket                         | 16.95 ea.  |

## KICK PANELS WITH SPEAKERS



| Part # | Year  | Model | Part                           | Price       |
|--------|-------|-------|--------------------------------|-------------|
| 15246  | 58    | All   | Kick Panel Speakers            | 179.95 Pair |
| 11655  | 59-60 | All   | Kick Panel Speakers (160 Watt) | 179.95 Pair |
| 11656  | 61-62 | All   | Kick Panel Speakers (150 Watt) | 179.95 Pair |
| 11657  | 63    | All   | Kick Panel Speakers (150 Watt) | 179.95 Pair |
| 11658  | 64    | All   | Kick Panel Speakers (150 Watt) | 179.95 Pair |



Custom Autosound Mfg., Inc. established in 1977, started manufacturing AM/FM cassettes in 1981. We now have eight models available! They are shipped 'bare' from overseas to Fullerton CA, where our technicians 'kit' (modify) them for over 400 different makes and models of classic cars and trucks

**WARNING:** All radios listed in this catalog cannot be used with original speakers. You must update with some form of late model speaker.

## SPEAKERS



**NOTE:** Some speakers come without brackets, must modify original bracket to use with dual speakers.

| Part # | Year  | Model  | Part                       | Price       |
|--------|-------|--------|----------------------------|-------------|
| 267    | 58-60 | All    | Dual Speaker               | 36.95 Ea.   |
| 11654  | 63-64 | All    | Dual Speaker               | 35.95 Ea.   |
| 15443  | 61-62 | All    | Dual Speaker               | 35.95 Ea.   |
| 15247  | 65-66 | w/o AC | Dual Speaker               | 40.95 Ea.   |
| 15248  | 65-66 | w/AC   | Dual Speaker               | 40.95 Ea.   |
| 15249  | 67-68 | w/o AC | Dual Speaker               | 40.95 Ea.   |
| 15250  | 67-68 | w/AC   | Dual Speaker               | 40.95 Ea.   |
| 15251  | 69-70 | All    | Dual Speaker               | 40.95 Ea.   |
| 3915   | 58-70 | All    | Rear Speakers w/Grilles    | 79.95 Pair  |
| 15444  | 58-66 | All    | Rear Dual Speakers         | 55.95 Ea.   |
| 15344  | 62-64 | Impala | Rear Speaker Grille Emblem | 18.95 Ea.   |
| 4249   | 58-70 | All    | Undercover Speakers        | 139.95 Pair |

<sup>e</sup> = add \$16.95 handling per item

# Speakers / Radios

## REAR SPEAKER GRILLES



12977



12849



12850

| Part # | Year  | Model       | Part                | Price      |
|--------|-------|-------------|---------------------|------------|
| 12977  | 58-60 | Convertible | Rear Speaker Cover  | 22.95 Ea.  |
| 12849  | 62-64 | Impala      | Rear Speaker Grille | 109.95 Ea. |
| 12850  | 65-67 | Impala      | Rear Speaker Grille | 109.95 Ea. |

## CD PLAYERS



All control is from the buttons on your USA-630, Sidebar or Secretaudio radio

- Plays CD/CD-R/CD-RW/DVD audio/WMA/MP3
- Small enough to hide under the seat or in glove box
- ESP Electronic Shock Protection
- Repeat/ Program/Random/Intro Function
- Multi-Angle Playback
- Last Position Memory
- 9' Cable for connection to CAM head unit
- Dimensions: 7" wide x 1" high x 6-3/4 deep

| Part # | Model                           | Part             | Price      |
|--------|---------------------------------|------------------|------------|
| 2059   | w/USA630 or Secret Audio System | Single CD Player | 169.95 ea. |

## BLUE TOOTH KITS



Wireless interface for Custom Autosound CD controller radios (USA-630, Secretaudio (SST & SRMS), USA-66). This adapter plugs into the CD changer port of your Custom Autosound radio and gives you the ability to do hands free calling from your bluetooth capable phone.

Also listen to music stored on your A2DP enabled bluetooth device. If you have a CD changer or CD1 single player you can still use it with the adapter plugged in

(there is a CD changer port on the control box of the Bluekit).

Main control box has a 1.5' cord that goes to radio CD port, 6.5' cord to answer button and 3.5' cord from answer button to microphone.

| Part # | Model                         | Part                  | Price      |
|--------|-------------------------------|-----------------------|------------|
| 4552   | All w/630 or Slide Bar Radios | Bluetooth Adapter Kit | 109.95 Kit |

**WARNING:** All radios listed in this catalog cannot be used with original speakers. You must update with some form of late model speaker.

## SECRET AUDIO SYSTEM



3914

Hideaway 200 Watt AM/FM CD controller with USB MP3/WMA Flash Drive, iPod interface and more. Featuring "RF" (radio frequency) remote control. Ideal for Streetrods, Classics, Customs or any Vehicle! Leave original radio intact! LCD display unit can be mounted almost anywhere and be controlled by wireless remote from up to 40 feet away. The tuner/ amplifier unit (black box) can be hidden out of site (under seat, dash or trunk). Comes with 10' cable from LCD panel to tuner/amp. Two mounting options included for the LCD control panel! (Flush mount bezel, or a swivel mount bracket!) We have even included the iPod docking cable (iPod not included).

| Part # | Year  | Model | Part                | Price      |
|--------|-------|-------|---------------------|------------|
| 3914   | 64-72 | All   | Secret Audio System | 399.95 Ea. |

## USA 230 RADIOS



11645



11646



11647



11648



11649



11650



11651



11652



11653

If you don't need USB/MP3 or CD changer control this is the model for you. An awesome looking radio at a great price. Radio has no cassette but comes with auxiliary audio input. If you have a portable MP3 player or Satellite radio just plug it into the Aux input and listen to it through this radio. Our kits modify each radio to fit specific vehicles right out of the box. No extra kits/bezels needed!

- AM-FM Stereo
- 200 Watts (4x50)
- Auxiliary Input (RCA Rear) RCA to 1/8" pin jack included
- Digital Clock
- Electronic Tuner
- 16 Pre-sets (4AM-12FM)
- 4 Channel RCA Pre-outs
- 4 way Fader
- Power Antenna Lead

| Part # | Year  | Model | Part                | Price      |
|--------|-------|-------|---------------------|------------|
| 11645  | 58    | All   | Usa-230 AM/FM Radio | 169.95 Ea. |
| 11646  | 59-60 | All   | Usa-230 AM/FM Radio | 169.95 Ea. |
| 11647  | 61-62 | All   | Usa-230 AM/FM Radio | 169.95 Ea. |
| 11648  | 63-64 | All   | Usa-230 AM/FM Radio | 169.95 Ea. |
| 11649  | 65    | All   | Usa-230 AM/FM Radio | 169.95 Ea. |
| 11650  | 66    | All   | Usa-230 AM/FM Radio | 169.95 Ea. |
| 11651  | 67-68 | All   | Usa-230 AM/FM Radio | 169.95 Ea. |
| 11652  | 69    | All   | Usa-230 AM/FM Radio | 169.95 Ea. |
| 11653  | 70    | All   | Usa-230 AM/FM Radio | 169.95 Ea. |

# Radios / Antennas

## USA 630 RADIOS



This radio has large OEM style push-buttons that give a perfect look in a classic dash. Although it looks classic it has the latest modern features.

USB input on the back of the radio allows you to plug in a USB flash drive for playback of MP3/WMA song files. This jack is on an 14" extension which allows you to place it in the glove box or ash tray for easy access (no unsightly wires or plugs hanging out of the front of the radio). The new alpha numeric display (30% larger than previous models) shows the song/artist/album (id3) titles during playback of MP3/WMA files. w/ the built in CD controller you have complete control (no FM modulation) of CAM's 6 disc CD changer. This same CD controller also facilitates the optional iPod® interface that turns your iPod on/off and charge it while giving you control to advance songs or play list from the buttons on the radio. A great feature so you can keep the iPod hidden away in your glove box or console. The back of the radio also has auxiliary audio input for satellite radio or any portable player you may wish to use. Our kits modify each radio to fit specific vehicles right out of the box. No extra kits/bezels needed!

•AM-FM Stereo • 240 Watts • USB Port for Flash Memory MP3/WMA Playback • Direct 10 CD Changer Control • Alpha Numeric id3 Display for MP3/WMA files •Electronic Tuning and Volume Control • 4 way Fader • Left Right Balance • Digital Clock • 2 Channel RCA Auxiliary Input for Satellite / iPod etc. • 16 Pre-sets (12FM-4AM) • 4 Channel RCA Pre-outs • Separate Bass and Treble • USA/Euro Tuner • Power Antenna Lead

| Part # | Year  | Model | Part                | Price      |
|--------|-------|-------|---------------------|------------|
| 15237  | 58    | Chevy | USA 630 AM/FM Radio | 239.95 Ea. |
| 15238  | 59-60 | Chevy | USA 630 AM/FM Radio | 239.95 Ea. |
| 15239  | 61-62 | Chevy | USA 630 AM/FM Radio | 239.95 Ea. |
| 15240  | 63-64 | Chevy | USA 630 AM/FM Radio | 239.95 Ea. |
| 15241  | 65    | Chevy | USA 630 AM/FM Radio | 239.95 Ea. |
| 15242  | 66    | Chevy | USA 630 AM/FM Radio | 239.95 Ea. |
| 15243  | 67-68 | Chevy | USA 630 AM/FM Radio | 239.95 Ea. |
| 15244  | 69    | Chevy | USA 630 AM/FM Radio | 239.95 Ea. |
| 15245  | 70    | Chevy | USA 630 AM/FM Radio | 239.95 Ea. |

## USA 740 RADIOS



The USA-740 offers the same classic look that Custom Autosound has always been known for with today's latest features. Now, with built-in Bluetooth (microphone included), answer calls and get Bluetooth streaming music from your Bluetooth capable phone or Bluetooth compatible device. Classic style with today's sound and performance taking every road and curve with you in your vintage vehicle.

• AM-FM Stereo • 300-watt • Hi 4volt, 4channel RCA Pre-outs and a Subwoofer RCA pre-out for additional amplifiers. • USB input • Front mini jack auxiliary audio input • Rear RCA auxiliary audio input

Match the dominant color of your instrument cluster with user selectable multiple LCD color choices with LCD dimmer control. The AM/FM RDS tuner shows station, song and artist on the LCD display. For those of us committed to music collections on compact disc, the USA-740 fully controls our optional CD-1 CD player.

| Part # | Year  | Model  | Part                           | Price      |
|--------|-------|--------|--------------------------------|------------|
| 16527  | 58    | Impala | USA-740 AM/FM Blue Tooth Radio | 319.95 Ea. |
| 16528  | 59-60 | Impala | USA-740 AM/FM Blue Tooth Radio | 319.95 Ea. |
| 16529  | 61-62 | Impala | USA-740 AM/FM Blue Tooth Radio | 319.95 Ea. |
| 16530  | 63-64 | Impala | USA-740 AM/FM Blue Tooth Radio | 319.95 Ea. |
| 16531  | 65    | Impala | USA-740 AM/FM Blue Tooth Radio | 319.95 Ea. |
| 16532  | 66    | Impala | USA-740 AM/FM Blue Tooth Radio | 319.95 Ea. |
| 16533  | 67-68 | Impala | USA-740 AM/FM Blue Tooth Radio | 319.95 Ea. |
| 16534  | 69    | Impala | USA-740 AM/FM Blue Tooth Radio | 319.95 Ea. |
| 16535  | 70    | Impala | USA-740 AM/FM Blue Tooth Radio | 319.95 Ea. |

**WARNING:** All radios listed in this catalog cannot be used with original speakers. You must update with some form of late model speaker.

# Radios / Antennas

## RADIO GROUND STRAP KITS



| Part # | Year  | Model | Part             | Price     |
|--------|-------|-------|------------------|-----------|
| 11140  | 58    | All   | Ground Strap Kit | 20.95 Kit |
| 11141  | 59-60 | All   | Ground Strap Kit | 20.95 Kit |
| 11142  | 61-64 | All   | Ground Strap Kit | 30.95 Kit |
| 11143  | 65-66 | All   | Ground Strap Kit | 20.95 Kit |

## RADIO KNOBS



| Part # | Year  | Model  | Part                            | Price      |
|--------|-------|--------|---------------------------------|------------|
| 13178  | 61-63 | Impala | Radio Knob                      | 11.95 Ea.  |
| 13179  | 64    | Impala | Radio Knob                      | 9.95 Ea.   |
| 15300  | 67-68 | Impala | Mono Radio Knob Set             | 23.95 Set  |
| 15301  | 67-68 | Impala | Stereo Radio Knob Set           | 23.95 Set  |
| 15302  | 69-70 | Impala | Radio Knobs                     | 17.95 Pair |
| 15303  | 69-70 | Impala | Mono Radio Tone & Fader Knobs   | 13.95 Pair |
| 15304  | 69-70 | Impala | Stereo Radio Tone & Fader Knobs | 13.95 Pair |

## ANTENNA NUTS



| Part # | Year  | Model | Part                      | Price     |
|--------|-------|-------|---------------------------|-----------|
| 10035  | 58    | All   | Rear Antenna Nut          | 10.95 Ea. |
| 10036  | 59-60 | All   | Rear Antenna Nut          | 29.95 Ea. |
| 10037  | 63-64 | All   | Rear Antenna Nut          | 8.95 Ea.  |
| 13113  | 65-68 | All   | Rear Antenna Nut          | 10.95 Ea. |
| 16144  | 65-68 | All   | Bezel Nut (Front Or Rear) | 8.95 Ea.  |

## ANTENNA GASKETS



| Part # | Year  | Model | Part                      | Price    |
|--------|-------|-------|---------------------------|----------|
| 10042  | 58    | All   | Antenna Gasket            | 4.00 Ea. |
| 10043  | 59    | All   | Rear Antenna Gasket LH/RH | 6.95 Ea. |
| 10044  | 60    | All   | Rear Antenna Gasket LH    | 6.95 Ea. |
| 10045  | 60    | All   | Rear Antenna Gasket RH    | 6.95 Ea. |
| 10046  | 61-62 | All   | Rear Antenna Gasket LH    | 6.95 Ea. |
| 10047  | 61-62 | All   | Rear Antenna Gasket RH    | 6.95 Ea. |
| 10048  | 68    | All   | Antenna Gasket            | 1.50 Ea. |

## ANTENNA BASES



| Part # | Year  | Model | Part              | Price     |
|--------|-------|-------|-------------------|-----------|
| 10039  | 59-60 | All   | Rear Antenna Base | 26.95 Ea. |
| 10040  | 61-62 | All   | Rear Antenna Base | 25.95 Ea. |
| 10041  | 63-64 | All   | Rear Antenna Base | 12.95 Ea. |
| 13112  | 65-66 | All   | Rear Antenna Base | 12.95 Ea. |

## ANTENNAS



| Part # | Year  | Model | Part                       | Price     |
|--------|-------|-------|----------------------------|-----------|
| 16145  | 61-62 | All   | Front Antenna Assembly     | 59.95 Ea. |
| 10025  | 63-64 | All   | Front Antenna Assembly     | 48.95 Ea. |
| 12807  | 65-66 | w/AM  | Front Antenna Assembly     | 85.95 Ea. |
| 12808  | 65-66 | w/FM  | Front Antenna Assembly     | 75.95 Ea. |
| 10026  | 58    | All   | Rear Antenna Assembly      | 89.95 Ea. |
| 10027  | 59-60 | All   | Rear Antenna Assembly LH   | 89.95 Ea. |
| 10028  | 59-60 | All   | Rear Antenna Assembly RH   | 89.95 Ea. |
| 10029  | 61-62 | All   | Rear Antenna Assembly LH   | 89.95 Ea. |
| 10030  | 61-62 | All   | Rear Antenna Assembly RH   | 89.95 Ea. |
| 10031  | 63    | All   | Rear Antenna Assembly LH   | 69.95 Ea. |
| 10032  | 63    | All   | Rear Antenna Assembly RH   | 69.95 Ea. |
| 10033  | 64    | All   | Rear Antenna Assembly LH   | 75.95 Ea. |
| 10034  | 64    | All   | Rear Antenna Assembly RH   | 75.95 Ea. |
| 13116  | 65    | All   | Rear Antenna Assembly (AM) | 85.95 Ea. |
| 15201  | 65-66 | All   | Rear Antenna Assembly LH   | 65.95 Ea. |
| 15202  | 65-66 | All   | Rear Antenna Assembly RH   | 75.95 Ea. |
| 4012   | 58-70 | All   | Hide Away Antenna          | 35.95 Ea. |

# Roofrail Parts / Seat Belts

## ROOFRAIL WEATHERSTRIP SETS



| Part # | Year  | Model               | Part             | Price       |
|--------|-------|---------------------|------------------|-------------|
| 11659  | 58    | Impala 2-Dr Hardtop | Weatherstrip Set | 25.95 Pair  |
| 11660  | 58    | Belair 2-Dr Hardtop | Weatherstrip Set | 29.95 Pair  |
| 10364  | 58    | Convertible         | Weatherstrip Set | 299.95 Set  |
| 11661  | 59-60 | Impala 2-Dr Hardtop | Weatherstrip Set | 74.95 Pair  |
| 13176  | 59-60 | Impala 4-Dr Hardtop | Weatherstrip Set | 125.95 Pair |
| 10365  | 59-60 | Convertible         | Weatherstrip Set | 419.95 Set  |
| 11662  | 61    | Impala 2-Dr Hardtop | Weatherstrip Set | 109.95 Pair |
| 11663  | 62    | Impala 2-Dr Hardtop | Weatherstrip Set | 75.95 Pair  |
| 13177  | 61-62 | Impala 4-Dr Hardtop | Weatherstrip Set | 125.95 Pair |
| 11664  | 63-64 | Impala 2-Dr Hardtop | Weatherstrip Set | 69.95 Pair  |
| 11665  | 63-64 | Impala 4-Dr Hardtop | Weatherstrip Set | 79.95 Pair  |
| 10366  | 61-64 | Convertible         | Weatherstrip Set | 259.95 Set  |
| 11666  | 65-66 | Impala 2-Dr Hardtop | Weatherstrip Set | 69.95 Pair  |
| 11667  | 65-66 | Impala 4-Dr Hardtop | Weatherstrip Set | 79.95 Pair  |
| 10367  | 65    | Convertible         | Weatherstrip Set | 409.95 Set  |
| 10368  | 66-70 | Convertible         | Weatherstrip Set | 299.95 Set  |
| 11668  | 67-68 | Impala 2-Dr Hardtop | Weatherstrip Set | 75.95 Pair  |
| 15215  | 67-68 | 4-Dr Hardtop        | Weatherstrip Set | 189.95 Pair |
| 11669  | 69-70 | Impala 2-Dr Hardtop | Weatherstrip Set | 75.95 Pair  |
| 11670  | 69-70 | Impala 4-Dr Hardtop | Weatherstrip Set | 79.95 Pair  |

## FRONT SEAT BELTS



| Part # | Year  | Model | Part       | Price     |
|--------|-------|-------|------------|-----------|
| 1641   | 58-64 | All   | Black      | 27.95 Ea. |
| 2024   | 58-64 | All   | Red        | 27.95 Ea. |
| 2025   | 58-64 | All   | Flame Red  | 27.95 Ea. |
| 2026   | 58-64 | All   | Maroon     | 27.95 Ea. |
| 2027   | 58-64 | All   | Tan        | 27.95 Ea. |
| 2028   | 58-64 | All   | Brown      | 27.95 Ea. |
| 2029   | 58-64 | All   | Dark Brown | 27.95 Ea. |
| 2030   | 58-64 | All   | Blue       | 27.95 Ea. |
| 2031   | 58-64 | All   | Dark Blue  | 27.95 Ea. |
| 2032   | 58-64 | All   | Turquoise  | 27.95 Ea. |
| 2033   | 58-64 | All   | Green      | 27.95 Ea. |
| 2034   | 58-64 | All   | Dark Green | 27.95 Ea. |
| 2035   | 58-64 | All   | Gray       | 27.95 Ea. |
| 2036   | 58-64 | All   | Silver     | 27.95 Ea. |
| 2037   | 58-64 | All   | Orange     | 27.95 Ea. |
| 2038   | 58-64 | All   | Ivory      | 27.95 Ea. |
| 2039   | 58-64 | All   | White      | 27.95 Ea. |

## ORIGINAL SEAT BELTS



| Part # | Year | Model     | Part                 | Price      |
|--------|------|-----------|----------------------|------------|
| 11723  | 65   | All       | Front Belts Black    | 139.95 Ea. |
| 15326  | 66   | All       | Front Belts Black    | 149.95 Ea. |
| 11724  | 68   | w/Buckets | Front Belts Black LH | 137.95 Ea. |
| 11725  | 68   | w/Buckets | Front Belts Black RH | 137.95 Ea. |
| 15327  | 66   | All       | Rear Belts Black     | 119.95 Ea. |

## 3-POINT SEAT BELTS



| Part # | Year  | Model | Part                         | Price       |
|--------|-------|-------|------------------------------|-------------|
| 3955   | 58-70 | All   | 3-Point Seat Belts Red       | 199.95 Pair |
| 3956   | 58-70 | All   | 3-Point Seat Belts Black     | 199.95 Pair |
| 3957   | 58-70 | All   | 3-Point Seat Belts Turquoise | 199.95 Pair |
| 3958   | 58-70 | All   | 3-Point Seat Belts Gray      | 199.95 Pair |
| 3959   | 58-70 | All   | 3-Point Seat Belts Silver    | 199.95 Pair |

# Seat Belts / Seat Parts / Sheet Metal

## REAR SEAT BELTS



| Part # | Year  | Model | Part       | Price     |
|--------|-------|-------|------------|-----------|
| 1642   | 58-64 | All   | Black      | 30.95 Ea. |
| 2040   | 58-64 | All   | Red        | 30.95 Ea. |
| 2041   | 58-64 | All   | Flame Red  | 30.95 Ea. |
| 2042   | 58-64 | All   | Maroon     | 30.95 Ea. |
| 2043   | 58-64 | All   | Tan        | 30.95 Ea. |
| 2044   | 58-64 | All   | Brown      | 30.95 Ea. |
| 2045   | 58-64 | All   | Dark Brown | 30.95 Ea. |
| 2046   | 58-64 | All   | Blue       | 30.95 Ea. |
| 2047   | 58-64 | All   | Dark Blue  | 30.95 Ea. |
| 2048   | 58-64 | All   | Turquoise  | 30.95 Ea. |
| 2049   | 58-64 | All   | Green      | 30.95 Ea. |
| 2050   | 58-64 | All   | Dark Green | 30.95 Ea. |
| 2051   | 58-64 | All   | Gray       | 30.95 Ea. |
| 2052   | 58-64 | All   | Silver     | 30.95 Ea. |
| 2053   | 58-64 | All   | Orange     | 30.95 Ea. |
| 2054   | 58-64 | All   | Ivory      | 30.95 Ea. |
| 2055   | 58-64 | All   | White      | 30.95 Ea. |

## SEAT STOPS



| Part # | Year  | Model     | Part            | Price     |
|--------|-------|-----------|-----------------|-----------|
| 12990  | 58    | All       | Seat Back Stops | 12.95 Set |
| 11691  | 62-64 | Impala SS | Seat Back Stops | 19.95 Set |
| 15336  | 66-70 | All       | Seat Back Stops | 5.00 Pair |
| 15630  | 61-68 | W/Bench   | Seat Back Stops | 12.95 Set |

## SEAT TRIM



| Part # | Year  | Model          | Part                                      | Price      |
|--------|-------|----------------|---|------------|
| 13114  | 62-66 | w/Bucket Seats | Bucket Seat Retaining Cap                 | 7.95 Pair  |
| 15997  | 62-64 | w/Bucket Seats | Seat Chrome LH                            | 199.95 Set |
| 15998  | 62-64 | w/Bucket Seats | Seat Chrome RH                            | 199.95 Set |
| 15999  | 65    | w/Bucket Seats | Seat Chrome LH Or RH (2 required per car) | 229.95 Set |

## SEAT TRACK ASSEMBLIES



| Part # | Year  | Model          | Part                     | Price       |
|--------|-------|----------------|--------------------------|-------------|
| 16176  | 62-64 | w/Bucket Seats | Seat Track Assemblies LH | 159.95 Set  |
| 16177  | 62-64 | w/Bucket Seats | Seat Track Assemblies RH | 159.95 Set  |
| 16324  | 66-69 | w/Bucket Seats | Seat Track               | 269.95 Pair |

## HOG RINGS



| Part # | Year  | Model | Part                   | Price     |
|--------|-------|-------|------------------------|-----------|
| 3558   | 58-70 | All   | Medium Sized Hog Rings | 3.50 Set  |
| 3559   | 58-70 | All   | Large Sized Hog Rings  | 4.00 Set  |
| 3591   | 58-70 | All   | Hog Ring Pliers        | 24.95 Ea. |

## SEAT FOAM



| Part #  | Year  | Model | Part                  | Price      |
|---------|-------|-------|-----------------------|------------|
| 13402 ② | 59-66 | 2-Dr  | Front Bench Seat Foam | 259.95 Set |
| 13403 ② | 62-63 | 2-Dr  | Bucket Seat Foam      | 99.95 Set  |
| 15097 ② | 64    | 2-Dr  | Bucket Seat Foam      | 99.95 Set  |
| 15098 ② | 65    | 2-Dr  | Bucket Seat Foam      | 99.95 Set  |
| 13404 ② | 66-69 | 2-Dr  | Bucket Seat Foam      | 99.95 Set  |

## SEAT KNOBS



| Part # | Year  | Model     | Part                 | Price     |
|--------|-------|-----------|----------------------|-----------|
| 11726  | 58-60 | All       | Seat Adjustment Knob | 30.95 Ea. |
| 11727  | 61-64 | Impala    | Seat Adjustment Knob | 30.95 Ea. |
| 11728  | 62-64 | Impala SS | Seat Adjustment Knob | 30.95 Ea. |
| 11729  | 65-66 | All       | Seat Adjustment Knob | 30.95 Ea. |
| 11730  | 68-72 | All       | Seat Adjustment Knob | 9.95 Ea.  |

## HEADLIGHT PANELS

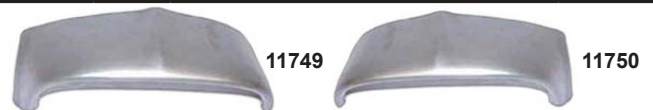

| Part # | Year | Model | Part             | Price     |
|--------|------|-------|------------------|-----------|
| 11749  | 58   | All   | Headlight Cap LH | 75.95 Ea. |
| 11750  | 58   | All   | Headlight Cap RH | 75.95 Ea. |

② = add \$16.95 handling per item

# Sheet Metal

## INNER DOOR BOTTOMS



| Part #  | Year  | Model | Part                 | Price      |
|---------|-------|-------|----------------------|------------|
| 12878 ① | 61-64 | All   | Inner Door Bottom LH | 159.95 Ea. |
| 12879 ① | 61-64 | All   | Inner Door Bottom RH | 159.95 Ea. |

## DOORS & DOOR SKINS



| Part #    | Year  | Model                   | Part              | Price      |
|-----------|-------|-------------------------|-------------------|------------|
| 15127 ③   | 61-62 | Hardtop/<br>Convertible | Full Door Skin LH | 299.95 Ea. |
| 15128 ③   | 61-62 | Hardtop/<br>Convertible | Full Door Skin RH | 299.95 Ea. |
| 13128 ③   | 63-64 | Hardtop/<br>Convertible | Full Door Skin LH | 259.95 Ea. |
| 13129 ③   | 63-64 | Hardtop/<br>Convertible | Full Door Skin RH | 259.95 Ea. |
| 15284 ☆ ④ | 63    | Hardtop                 | Door Shell LH     | 479.95 Ea. |
| 15285 ☆ ④ | 63    | Hardtop                 | Door Shell RH     | 479.95 Ea. |
| 15286 ☆ ④ | 64    | Hardtop                 | Door Shell LH     | 479.95 Ea. |
| 15287 ☆ ④ | 64    | Hardtop                 | Door Shell RH     | 479.95 Ea. |

## HOODS



| Part #  | Year  | Model | Part       | Price      |
|---------|-------|-------|------------|------------|
| 16483 ④ | 62    | All   | Hood       | 499.95 Ea. |
| 11731 ④ | 63    | All   | Steel Hood | 399.95 Ea. |
| 11732 ④ | 64    | All   | Steel Hood | 399.95 Ea. |
| 13058 ④ | 65-66 | All   | Steel Hood | 419.95 Ea. |

## INNER FENDER BOLT KIT



| Part # | Year  | Model | Part                  | Price    |
|--------|-------|-------|-----------------------|----------|
| 8255   | 61-70 | All   | Inner Fender Bolt Kit | 9.95 Kit |

☆ = special order non-stocking item, please allow 4-6 weeks for delivery.  
 ④ = truck freight (call for shipping quote)  
 ① = add \$8.95 handling per item  
 ③ = add \$80.95 handling per item

## FENDERS



| Part #    | Year | Model  | Part                      | Price      |
|-----------|------|--------|---------------------------|------------|
| 15757 ④ ☆ | 62   | All    | Fender LH                 | 439.95 Ea. |
| 15758 ④ ☆ | 62   | All    | Fender RH                 | 439.95 Ea. |
| 12863 ④   | 63   | Impala | Fender LH                 | 369.95 Ea. |
| 12864 ④   | 63   | Impala | Fender RH                 | 369.95 Ea. |
| 12865 ④   | 64   | Impala | Fender LH                 | 369.95 Ea. |
| 12866 ④   | 64   | Impala | Fender RH                 | 369.95 Ea. |
| 16509 ④ ☆ | 65   | All    | Fender LH                 | 509.95 Ea. |
| 16510 ④ ☆ | 65   | All    | Fender RH                 | 509.95 Ea. |
| 15780 ④   | 62   | All    | Inner Fender LH           | 169.95 Ea. |
| 15781 ④   | 62   | All    | Inner Fender RH           | 169.95 Ea. |
| 13059 ④   | 63   | All    | Inner Fender LH           | 165.95 Ea. |
| 13060 ④   | 63   | All    | Inner Fender RH           | 165.95 Ea. |
| 12868 ④   | 64   | All    | Inner Fender LH           | 169.95 Ea. |
| 12869 ④   | 64   | All    | Inner Fender RH           | 169.95 Ea. |
| 15686     | 64   | All    | Inner Fender Extension LH | 22.95 Ea.  |
| 15687     | 64   | All    | Inner Fender Extension RH | 22.95 Ea.  |
| 16139 ④ ☆ | 65   | All    | Inner Fender LH           | 169.95 Ea. |
| 16140 ④ ☆ | 65   | All    | Inner Fender RH           | 169.95 Ea. |
| 16141 ④ ☆ | 66   | All    | Inner Fender LH           | 169.95 Ea. |
| 16142 ④ ☆ | 66   | All    | Inner Fender RH           | 169.95 Ea. |

## FENDER PANELS



| Part # | Year  | Model | Part                  | Price     |
|--------|-------|-------|-----------------------|-----------|
| 11757  | 59    | All   | Fender Lower Panel LH | 65.95 Ea. |
| 11758  | 59    | All   | Fender Lower Panel RH | 65.95 Ea. |
| 11759  | 61    | All   | Fender Lower Panel LH | 79.95 Ea. |
| 11760  | 61    | All   | Fender Lower Panel RH | 79.95 Ea. |
| 11761  | 63    | All   | Fender Lower Panel LH | 79.95 Ea. |
| 11762  | 63    | All   | Fender Lower Panel RH | 79.95 Ea. |
| 11763  | 65-66 | All   | Fender Lower Panel LH | 79.95 Ea. |
| 11764  | 65-66 | All   | Fender Lower Panel RH | 79.95 Ea. |
| 11765  | 67-68 | All   | Fender Lower Panel LH | 59.95 Ea. |
| 11766  | 67-68 | All   | Fender Lower Panel RH | 59.95 Ea. |
| 11767  | 69-70 | All   | Fender Lower Panel LH | 59.95 Ea. |
| 11768  | 69-70 | All   | Fender Lower Panel RH | 59.95 Ea. |

# Sheet Metal

## FRONT QUARTER PANEL SECTIONS

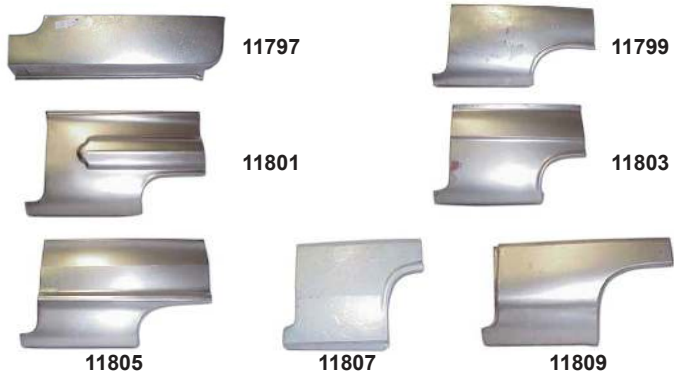

| Part #  | Year  | Model | Part                           | Price      |
|---------|-------|-------|--------------------------------|------------|
| 11797 ② | 58    | 2-Dr  | Quarter Panel Front Section LH | 95.95 Ea.  |
| 11798 ② | 58    | 2-Dr  | Quarter Panel Front Section RH | 95.95 Ea.  |
| 11799 ② | 59    | 2-Dr  | Quarter Panel Front Section LH | 119.95 Ea. |
| 11800 ② | 59    | 2-Dr  | Quarter Panel Front Section RH | 119.95 Ea. |
| 11803 ② | 61-62 | 2-Dr  | Quarter Panel Front Section LH | 119.95 Ea. |
| 11804 ② | 61-62 | 2-Dr  | Quarter Panel Front Section RH | 119.95 Ea. |
| 11805 ② | 63-64 | 2-Dr  | Quarter Panel Front Section LH | 155.95 Ea. |
| 11806 ② | 63-64 | 2-Dr  | Quarter Panel Front Section RH | 155.95 Ea. |
| 11807 ② | 65-66 | 2-Dr  | Quarter Panel Front Section LH | 99.95 Ea.  |
| 11808 ② | 65-66 | 2-Dr  | Quarter Panel Front Section RH | 99.95 Ea.  |
| 11809 ② | 67-68 | 2-Dr  | Quarter Panel Front Section LH | 149.95 Ea. |
| 11810 ② | 67-68 | 2-Dr  | Quarter Panel Front Section RH | 149.95 Ea. |

## 1958 FLOOR PANS



| Part #  | Year | Model | Part               | Price      |
|---------|------|-------|--------------------|------------|
| 11769 ① | 58   | All   | Toe Board LH       | 155.95 Ea. |
| 11770 ① | 58   | All   | Toe Board RH       | 155.95 Ea. |
| 11773 ① | 58   | All   | Front Floor Pan LH | 115.95 Ea. |
| 11774 ① | 58   | All   | Front Floor Pan RH | 115.95 Ea. |
| 11781 ① | 58   | All   | Rear Floor Pan LH  | 115.95 Ea. |
| 11782 ① | 58   | All   | Rear Floor Pan RH  | 115.95 Ea. |

## ROCKER PANELS



| Part #  | Year  | Model | Part                              | Price      |
|---------|-------|-------|-----------------------------------|------------|
| 11733 ② | 58    | 2-Dr  | Outer Rocker Panel LH             | 95.95 Ea.  |
| 11734 ② | 58    | 2-Dr  | Outer Rocker Panel RH             | 95.95 Ea.  |
| 11737 ② | 59-60 | 2-Dr  | Outer Rocker Panel LH             | 55.95 Ea.  |
| 11738 ② | 59-60 | 2-Dr  | Outer Rocker Panel RH             | 55.95 Ea.  |
| 11739 ② | 59-60 | 4-Dr  | Outer Rocker Panel LH             | 66.95 Ea.  |
| 11740 ② | 59-60 | 4-Dr  | Outer Rocker Panel RH             | 66.95 Ea.  |
| 11741 ② | 61-64 | 2-Dr  | Outer Rocker Panel LH             | 115.95 Ea. |
| 11742 ② | 61-64 | 2-Dr  | Outer Rocker Panel RH             | 115.95 Ea. |
| 11743 ② | 65-70 | 2-Dr  | Outer Rocker Panel LH             | 86.95 Ea.  |
| 11744 ② | 65-70 | 2-Dr  | Outer Rocker Panel RH             | 86.95 Ea.  |
| 11745 ② | 65-70 | 4-Dr  | Outer Rocker Panel LH             | 29.95 Ea.  |
| 11746 ② | 65-70 | 4-Dr  | Outer Rocker Panel RH             | 29.95 Ea.  |
| 11747 ② | 58    | All   | Inner Rocker Panel LH             | 115.95 Ea. |
| 11748 ② | 58    | All   | Inner Rocker Panel RH             | 115.95 Ea. |
| 16131 ① | 59-60 | All   | Inner Rocker Panel LH             | 92.95 Ea.  |
| 16132 ① | 59-60 | All   | Inner Rocker Panel RH             | 92.95 Ea.  |
| 15531 ② | 65-70 | All   | Inner Rocker Panel LH             | 99.95 Ea.  |
| 15532 ② | 65-70 | All   | Inner Rocker Panel RH             | 99.95 Ea.  |
| 15665 ② | 64    | All   | Inner/Outer Rocker Combo Panel LH | 179.95 Ea. |
| 15666 ② | 64    | All   | Inner/Outer Rocker Combo Panel RH | 179.95 Ea. |
| 16056   | 62-64 |       | Inner Rocker Panel LH             | 230.95 Ea. |
| 16057   | 62-64 |       | Inner Rocker Panel RH             | 230.95 Ea. |

## 1959-60 FLOOR PANS



| Part #  | Year  | Model | Part                     | Price      |
|---------|-------|-------|--------------------------|------------|
| 15504 ④ | 59-60 | All   | Full Floor Pan           | 699.95 Ea. |
| 11775 ① | 59-60 | All   | Front Floor Pan LH       | 109.95 Ea. |
| 11776 ① | 59-60 | All   | Front Floor Pan RH       | 109.95 Ea. |
| 11783 ① | 59-60 | All   | Rear Floor Pan LH        | 105.95 Ea. |
| 11784 ① | 59-60 | All   | Rear Floor Pan RH        | 105.95 Ea. |
| 11789 ① | 59-60 | All   | Under Rear Seat Panel LH | 115.95 Ea. |
| 11790 ① | 59-60 | All   | Under Rear Seat Panel RH | 115.95 Ea. |

④ = truck freight (call for shipping quote)  
 ① = add \$8.95 handling per item  
 ② = add \$16.95 handling per item

# Sheet Metal

## 1961-64 FLOOR PANS



| Part #  | Year  | Model | Part                     | Price      |
|---------|-------|-------|--------------------------|------------|
| 11771 ① | 61-64 | All   | Toe Board LH             | 159.95 Ea. |
| 11772 ① | 61-64 | All   | Toe Board RH             | 159.95 Ea. |
| 11777 ① | 61-64 | All   | Front Floor Pan LH       | 85.95 Ea.  |
| 11778 ① | 61-64 | All   | Front Floor Pan RH       | 85.95 Ea.  |
| 11785 ① | 61-64 | All   | Rear Floor Pan LH        | 79.95 Ea.  |
| 11786 ① | 61-64 | All   | Rear Floor Pan RH        | 79.95 Ea.  |
| 11791 ① | 61-64 | All   | Under Rear Seat Panel LH | 85.95 Ea.  |
| 11792 ① | 61-64 | All   | Under Rear Seat Panel RH | 85.95 Ea.  |
| 15542 ③ | 61-64 | All   | Under Seat Pan (1 Piece) | 99.95 Ea.  |
| 12871 ② | 61-64 | All   | Full Floor Pan LH        | 149.95 Ea. |
| 12872 ② | 61-64 | All   | Full Floor Pan RH        | 149.95 Ea. |

## 1965-70 FLOOR PANS



| Part #  | Year  | Model | Part                     | Price      |
|---------|-------|-------|--------------------------|------------|
| 11779 ① | 65-70 | All   | Front Floor Pan LH       | 105.95 Ea. |
| 11780 ① | 65-70 | All   | Front Floor Pan RH       | 105.95 Ea. |
| 11787 ① | 65-70 | All   | Rear Floor Pan LH        | 109.95 Ea. |
| 11788 ① | 65-70 | All   | Rear Floor Pan RH        | 109.95 Ea. |
| 13160 ② | 65-70 | All   | Full Floor Pan LH        | 169.95 Ea. |
| 13161 ② | 65-70 | All   | Full Floor Pan RH        | 169.95 Ea. |
| 13162 ③ | 65-70 | All   | Full Under Rear Seat Pan | 129.95 Ea. |

② = truck freight (call for shipping quote)  
 ① = add \$8.95 handling per item  
 ② = add \$16.95 handling per item  
 ③ = add \$80.95 handling per item

## REAR QUARTER PANEL SECTIONS

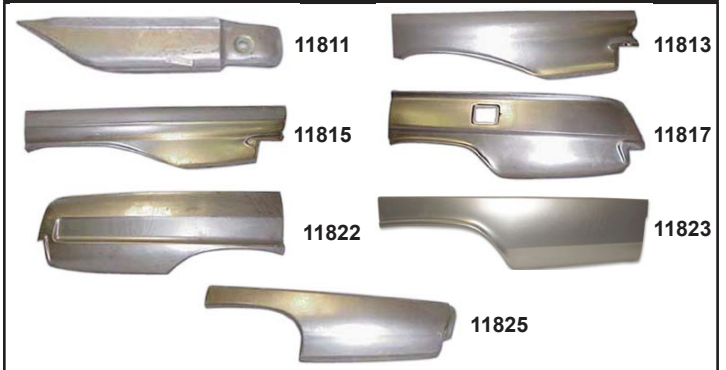

| Part #  | Year  | Model  | Part                          | Price      |
|---------|-------|--------|-------------------------------|------------|
| 11811 ① | 58    | 2/4-Dr | Quarter Panel Rear Section LH | 115.95 Ea. |
| 11812 ① | 58    | 2/4-Dr | Quarter Panel Rear Section RH | 115.95 Ea. |
| 11813 ② | 59    | 2/4-Dr | Quarter Panel Rear Section LH | 136.95 Ea. |
| 11814 ② | 59    | 2/4-Dr | Quarter Panel Rear Section RH | 136.95 Ea. |
| 11815 ② | 60    | 2/4-Dr | Quarter Panel Rear Section LH | 139.95 Ea. |
| 11816 ② | 60    | 2/4-Dr | Quarter Panel Rear Section RH | 139.95 Ea. |
| 11817 ② | 62    | 2/4-Dr | Quarter Panel Rear Section LH | 219.95 Ea. |
| 11818 ② | 62    | 2/4-Dr | Quarter Panel Rear Section RH | 219.95 Ea. |
| 11820 ② | 63    | 2/4-Dr | Quarter Panel Rear Section RH | 249.95 Ea. |
| 11821 ② | 64    | 2/4-Dr | Quarter Panel Rear Section LH | 199.95 Ea. |
| 11822 ② | 64    | 2/4-Dr | Quarter Panel Rear Section RH | 199.95 Ea. |
| 11823 ② | 65-66 | 2/4-Dr | Quarter Panel Rear Section LH | 179.95 Ea. |
| 11824 ② | 65-66 | 2/4-Dr | Quarter Panel Rear Section RH | 179.95 Ea. |
| 11825 ② | 67-68 | 2/4-Dr | Quarter Panel Rear Section LH | 174.95 Ea. |
| 11826 ② | 67-68 | 2/4-Dr | Quarter Panel Rear Section RH | 174.95 Ea. |

## QUARTER PANEL/TAILLIGHT AREA PANEL



| Part #  | Year | Model            | Part  | Price      |
|---------|------|------------------|---|------------|
| 16149   | 62   | All              | Taillight Mounting Panel LH                     | 95.95 Ea.  |
| 16150   | 62   | All              | Taillight Mounting Panel RH                     | 95.95 Ea.  |
| 13140   | 63   | All              | Quarter/Taillight Panel LH                      | 99.95 Ea.  |
| 13141   | 63   | All              | Quarter/Taillight Panel RH                      | 99.95 Ea.  |
| 13142   | 64   | All              | Quarter/Taillight Panel LH                      | 75.95 Ea.  |
| 13143   | 64   | All              | Quarter/Taillight Panel RH                      | 75.95 Ea.  |
| 16512   | 66   | All Except Wagon | Taillight Surround LH                           | 59.95 Ea.  |
| 16513   | 66   | All Except Wagon | Taillight Surround RH                           | 59.95 Ea.  |
| 16514 ① | 66   | All Except Wagon | Trunk Rear Cross Rail w/Taillight Panel Bracing | 259.95 Ea. |

# Sheet Metal

## FULL FLOOR PAN ASSEMBLIES



15543/BOTTOM VIEW



15543/TOP VIEW



15535/TOP VIEW



15535/BOTTOM VIEW

| Part #    | Year  | Model | Part  | Price       |
|-----------|-------|-------|---|-------------|
| 15543 🚚 ★ | 61-64 | All   | Full Floor Pan Assembly w/o Rear Under Seat Pan | 1599.95 Ea. |
| 15535 🚚 ★ | 65-70 | All   | Full Floor Pan Assembly                         | 1499.95 Ea. |

## FULL QUARTER PANELS AND SKINS



11831



11833



11836



11837



11839

| Part #    | Year  | Model         | Part                  | Price      |
|-----------|-------|---------------|-----------------------|------------|
| 11829 🚚 ★ | 62    | All           | Quarter Panel Skin LH | 379.95 Ea. |
| 11830 🚚 ★ | 62    | All           | Quarter Panel Skin RH | 379.95 Ea. |
| 11831 🚚   | 63    | 2-Dr Impala   | Full Quarter Panel LH | 469.95 Ea. |
| 11832 🚚   | 63    | 2-Dr Impala   | Full Quarter Panel RH | 469.95 Ea. |
| 11833 🚚   | 64    | 2-Dr Impala   | Full Quarter Panel LH | 469.95 Ea. |
| 11834 🚚   | 64    | 2-Dr Impala   | Full Quarter Panel RH | 469.95 Ea. |
| 11835 🚚   | 65    | 2-Dr Impala   | Quarter Panel Skin LH | 289.95 Ea. |
| 11836 🚚   | 65    | 2-Dr Impala   | Quarter Panel Skin RH | 289.95 Ea. |
| 11837 🚚   | 66    | 2-Dr Impala   | Quarter Panel Skin LH | 289.95 Ea. |
| 11838 🚚   | 66    | 2-Dr Impala   | Quarter Panel Skin RH | 289.95 Ea. |
| 11839 🚚   | 69-70 | 2-Dr Fastback | Quarter Panel Skin LH | 279.95 Ea. |
| 11840 🚚   | 69-70 | 2-Dr Fastback | Quarter Panel Skin RH | 279.95 Ea. |

## WHEEL HOUSES



15448



13077



11843

| Part #  | Year  | Model                     | Part                    | Price      |
|---------|-------|---------------------------|-------------------------|------------|
| 15448 ② | 63    | Hardtop/Sedan/Convertible | Wheel House LH          | 314.95 Ea. |
| 15449 ② | 63    | Hardtop/Sedan/Convertible | Wheel House RH          | 314.95 Ea. |
| 13077 ② | 64    | Hardtop/Sedan/Convertible | Wheel House LH          | 329.95 Ea. |
| 13078 ② | 64    | Hardtop/Sedan/Convertible | Wheel House RH          | 329.95 Ea. |
| 15787 ③ | 65-66 | Hardtop                   | Complete Wheel House LH | 259.95 Ea. |
| 15788 ③ | 65-66 | Hardtop                   | Complete Wheel House RH | 259.95 Ea. |
| 11843 ② | 65-66 | Hardtop/Sedan             | Outer Wheel House LH    | 99.95 Ea.  |
| 11844 ② | 65-66 | Hardtop/Sedan             | Outer Wheel House RH    | 99.95 Ea.  |

## WHEEL HOUSE BRACES



15622



15623

| Part # | Year  | Model | Part                            | Price     |
|--------|-------|-------|---------------------------------|-----------|
| 15528  | 63-64 | All   | Wheel House To Rocker Brace LH  | 22.95 Ea. |
| 15529  | 63-64 | All   | Wheel House To Rocker Brace RH  | 22.95 Ea. |
| 15622  | 63-64 | All   | Wheel House To Quarter Brace LH | 39.95 Ea. |
| 15623  | 63-64 | All   | Wheel House To Quarter Brace RH | 39.95 Ea. |

## WHEEL OPENING REPAIR PANEL



16043



16045

| Part #  | Year | Model | Part                          | Price      |
|---------|------|-------|-------------------------------|------------|
| 16043 ② | 61   | 2-Dr  | Wheel Opening Repair Panel LH | 159.95 Ea. |
| 16044 ② | 61   | 2-Dr  | Wheel Opening Repair Panel RH | 159.95 Ea. |
| 16045 ② | 62   | 2-Dr  | Wheel Opening Repair Panel LH | 129.95 Ea. |
| 16046 ② | 62   | 2-Dr  | Wheel Opening Repair Panel RH | 129.95 Ea. |

★ = special order non-stocking item, please allow 4-6 weeks for delivery.  
 🚚 = truck freight (call for shipping quote)  
 ② = add \$16.95 handling per item  
 ③ = add \$80.95 handling per item

# Sheet Metal

## 1958-60 TRUNK PANELS

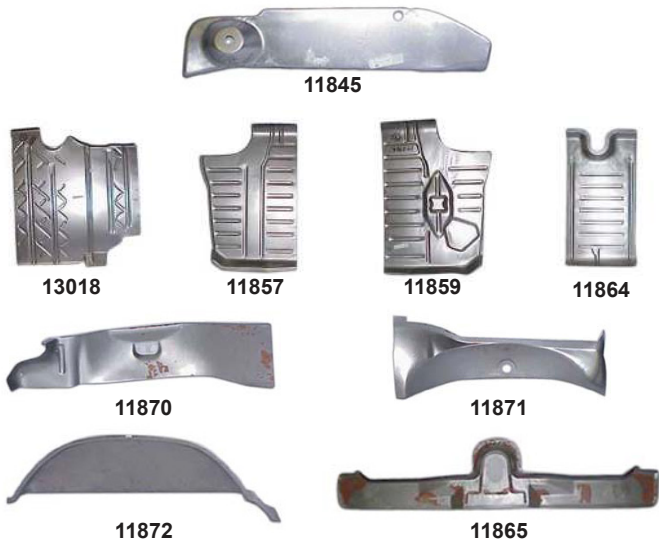

| Part # | Year  | Model            | Part                           | Price      |
|--------|-------|------------------|--------------------------------|------------|
| 11845  | 58    | All              | Trunk Filler Panel LH          | 119.95 Ea. |
| 11846  | 58    | All              | Trunk Filler Panel RH          | 119.95 Ea. |
| 13018  | 58    | All              | Trunk Floor Side LH            | 155.95 Ea. |
| 13019  | 58    | All              | Trunk Floor Side RH            | 155.95 Ea. |
| 11857  | 59-60 | All              | Trunk Floor Side LH            | 155.95 Ea. |
| 11858  | 59    | All              | Trunk Floor Side RH            | 155.95 Ea. |
| 11859  | 60    | All              | Trunk Floor Side RH            | 155.95 Ea. |
| 11864  | 59-60 | All              | Trunk Floor Center             | 155.95 Ea. |
| 11870  | 58    | All Except Wagon | Spare Tire Well                | 135.95 Ea. |
| 11871  | 59    | All Except Wagon | Spare Tire Well Bottom Section | 135.95 Ea. |
| 11872  | 59    | All Except Wagon | Spare Tire Well LH Side        | 135.95 Ea. |
| 11865  | 60    | All Except Wagon | Outer Trunk Floor Extension    | 169.95 Ea. |

## 1965-70 TRUNK PANELS

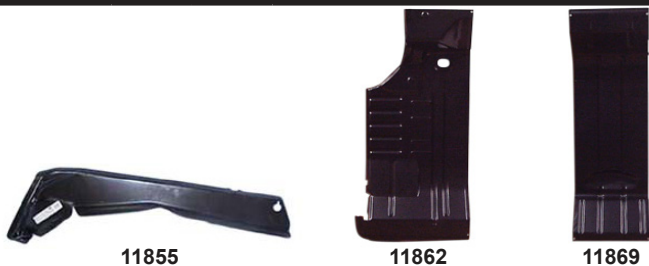

| Part # | Year  | Model | Part                      | Price     |
|--------|-------|-------|---------------------------|-----------|
| 11855  | 65-66 | All   | Filler Panel Extension LH | 69.95 Ea. |
| 11856  | 65-66 | All   | Filler Panel Extension RH | 69.95 Ea. |
| 11862  | 65-70 | All   | Trunk Floor Side LH       | 99.95 Ea. |
| 11863  | 65-70 | All   | Trunk Floor Side RH       | 99.95 Ea. |
| 11869  | 65-70 | All   | Trunk Floor Center        | 89.95 Ea. |

## 1961-64 TRUNK PANELS



| Part # | Year  | Model | Part                                   | Price      |
|--------|-------|-------|--|------------|
| 11847  | 61    | All   | Trunk Filler Panel LH                  | 80.95 Ea.  |
| 11849  | 62    | All   | Trunk Filler Panel LH                  | 109.95 Ea. |
| 11851  | 63    | All   | Trunk Filler Panel LH                  | 55.95 Ea.  |
| 11852  | 63    | All   | Trunk Filler Panel RH                  | 55.95 Ea.  |
| 11853  | 64    | All   | Trunk Filler Panel LH                  | 55.95 Ea.  |
| 11854  | 64    | All   | Trunk Filler Panel RH                  | 55.95 Ea.  |
| 11866  | 61    | All   | Outer Trunk Floor Section LH           | 109.95 Ea. |
| 11867  | 61    | All   | Outer Trunk Floor Section RH           | 109.95 Ea. |
| 12873  | 62-64 | All   | Full Trunk Floor                       | 499.95 Ea. |
| 11861  | 61-64 | All   | Trunk Floor Side RH                    | 109.95 Ea. |
| 11868  | 61-64 | All   | Trunk Floor Center                     | 119.95 Ea. |
| 16137  | 61-64 | All   | Trunk Shelf Panel                      | 429.95 Ea. |
| 15584  | 62    | All   | Trunk Weatherstrip Lip Repair Channels | 199.95 Set |
| 15585  | 63-64 | All   | Trunk Weatherstrip Lip Repair Channels | 199.95 Set |

## TRUNK LIDS



| Part # | Year | Model           | Part      | Price      |
|--------|------|-----------------|-----------|------------|
| 13064  | 63   | Impala          | Trunk Lid | 469.95 Ea. |
| 15477  | 64   | Impala          | Trunk Lid | 469.95 Ea. |
| 15634  | 64   | Biscayne/Belair | Trunk Lid | 459.95 Ea. |

★ = special order non-stocking item, please allow 4-6 weeks for delivery.  
 ☐ = truck freight (call for shipping quote)  
 Ⓢ = add \$16.95 handling per item

# Sheet Metal

## TAILPANS AND BRACES



13187



13188

| Part #  | Year  | Model     | Part                 | Price      |
|---------|-------|-----------|----------------------|------------|
| 16010 ① | 62    | Non-Wagon | Tailpan              | 159.95 Ea. |
| 15334 ② | 63    | Non-Wagon | Tailpan              | 99.95 Ea.  |
| 16011 ② | 65    | Non-Wagon | Tail Panel Assembly  | 185.95 Ea. |
| 16062 ② | 66    | Non-Wagon | Rear Body/Tail Panel | 269.95 Ea. |
| 13187 ② | 62-64 | All       | Tailpan Brace        | 139.95 Ea. |
| 15621 ② | 65    | All       | Tailpan Brace        | 139.95 Ea. |
| 13188 ② | 66    | All       | Tailpan Brace        | 149.95 Ea. |

## 1958 FLOOR BRACES



11873



11875



11877



11879

| Part # | Year | Model | Part                  | Price      |
|--------|------|-------|-----------------------|------------|
| 11873  | 58   | All   | First Floor Brace LH  | 105.95 Ea. |
| 11874  | 58   | All   | First Floor Brace RH  | 105.95 Ea. |
| 11875  | 58   | All   | Second Floor Brace LH | 105.95 Ea. |
| 11876  | 58   | All   | Second Floor Brace RH | 105.95 Ea. |
| 11877  | 58   | All   | Thrid Floor Brace LH  | 115.95 Ea. |
| 11878  | 58   | All   | Thrid Floor Brace RH  | 115.95 Ea. |
| 11879  | 58   | All   | Fourth Floor Brace LH | 105.95 Ea. |
| 11880  | 58   | All   | Fourth Floor Brace RH | 105.95 Ea. |

## TRUNK AREA DIVIDER PANEL



| Part #  | Year  | Model | Part                     | Price      |
|---------|-------|-------|--------------------------|------------|
| 13163 ② | 65-70 | All   | Trunk Area Divider Panel | 119.95 Ea. |

## BACK GLASS TO TRUNK PANELS



| Part #  | Year  | Model        | Part                      | Price      |
|---------|-------|--------------|---------------------------|------------|
| 16000 ② | 64    | 2-Dr Hardtop | Back Glass To Trunk Panel | 179.95 Ea. |
| 15198 ② | 65-66 | 2-Dr Hardtop | Back Glass To Trunk Panel | 109.95 Ea. |

## 1959-60 FLOOR BRACES



11881



11883



11885



11887

| Part # | Year  | Model | Part                        | Price      |
|--------|-------|-------|-----------------------------|------------|
| 11881  | 59-60 | All   | Front Floor Brace LH        | 105.95 Ea. |
| 11882  | 59-60 | All   | Front Floor Brace RH        | 105.95 Ea. |
| 11883  | 59-60 | All   | Underseat Mounting Brace LH | 85.95 Ea.  |
| 11884  | 59-60 | All   | Underseat Mounting Brace RH | 85.95 Ea.  |
| 11885  | 59-60 | All   | Middle Floor Brace LH       | 135.95 Ea. |
| 11886  | 59-60 | All   | Middle Floor Brace RH       | 135.95 Ea. |
| 11887  | 59-60 | All   | Rear Floor Brace LH         | 105.95 Ea. |
| 11888  | 59-60 | All   | Rear Floor Brace RH         | 105.95 Ea. |

## 1961-64 FLOOR BRACES



11889



13189



11891



11892



15801



13190



15684



11894

| Part #  | Year  | Model     | Part                       | Price       |
|---------|-------|-----------|----------------------------|-------------|
| 11889   | 61-64 | All       | Front Brace Outer 20" LH   | 55.95 Ea.   |
| 11890   | 61-64 | All       | Front Brace Outer 20" RH   | 55.95 Ea.   |
| 13189 ② | 62-64 | All       | Front Brace (Full Length)  | 109.95 Ea.  |
| 11891   | 61-64 | All       | Middle Floor Brace LH/RH   | 62.95 Ea.   |
| 11892   | 61-64 | All       | Rear Brace Outer 25" LH    | 69.95 Ea.   |
| 11893   | 61-64 | All       | Rear Brace Outer 25" RH    | 69.95 Ea.   |
| 13190 ② | 62-64 | All       | Rear Brace (Full Length)   | 129.95 Ea.  |
| 15801 ① | 61-64 | Non Wagon | Gas Tank Mount Brace       | 135.95 Ea.  |
| 15684   | 62-64 | w/Bucket  | Bucket Seat Mount Brackets | 109.95 Set  |
| 11894   | 61-64 | All       | Trunk Box Brace LH         | 65.95 Ea.   |
| 11895   | 61-64 | All       | Trunk Box Brace RH         | 65.95 Ea.   |
| 16055   | 61-64 | All       | Floor To Firewall Brace    | 155.95 Pair |

① = add \$8.95 handling per item  
 ② = add \$16.95 handling per item

# Sheet Metal / Steering Column Parts

## 1965-70 FLOOR BRACES



| Part #  | Year  | Model     | Part                           | Price      |
|---------|-------|-----------|--------------------------------|------------|
| 11896   | 65-66 | All       | Front Floor Brace LH           | 55.95 Ea.  |
| 11897   | 65-66 | All       | Front Floor Brace RH           | 55.95 Ea.  |
| 11386 ② | 65-70 | All       | Front Floor Brace (Full)       | 129.95 Ea. |
| 11898   | 65-66 | All       | Middle Floor Brace LH          | 55.95 Ea.  |
| 11899   | 65-66 | All       | Middle Floor Brace RH          | 55.95 Ea.  |
| 12210 ② | 65-70 | All       | Center Floor Brace (Full)      | 129.95 Ea. |
| 11900   | 65-66 | All       | Rear Brace Outer 25" LH        | 55.95 Ea.  |
| 11901   | 65-66 | All       | Rear Brace Outer 25" RH        | 55.95 Ea.  |
| 12582 ② | 65-70 | All       | Rear Floor Brace (Full)        | 129.95 Ea. |
| 11902   | 65-66 | All       | Floor Brace Over Rear Axle LH  | 45.95 Ea.  |
| 11903   | 65-66 | All       | Floor Brace Over Rear Axle RhH | 45.95 Ea.  |
| 11904 ① | 65-66 | All       | Trunk Brace For Gas Tank Mount | 59.95 Ea.  |
| 15891   | 65-70 | All       | Trunk Side Brace LH            | 49.95 Ea.  |
| 15892   | 65-70 | All       | Trunk Side Brace RH            | 49.95 Ea.  |
| 15685   | 65    | w/Buckets | Bucket Seat Mount Brackets     | 89.95 Set  |

## REAR SEAT SIDE PANELS



| Part # | Year  | Model   | Part                  | Price      |
|--------|-------|---------|-----------------------|------------|
| 16050  | 62-64 | Hardtop | Rear Seat Side Panels | 87.95 Pair |

## TRUNK FLOOR ASSEMBLIES

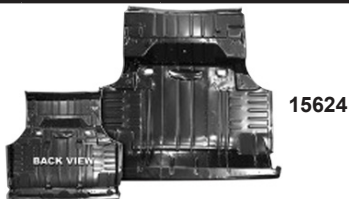

| Part #    | Year | Model | Part                 | Price       |
|-----------|------|-------|----------------------|-------------|
| 15620 ★ ② | 65   | All   | Trunk Floor Assembly | 1399.95 Ea. |
| 15624 ★ ② | 66   | All   | Trunk Floor Assembly | 1399.95 Ea. |

## HORN CONTACT / UPPER COLUMN BEARINGS



| Part # | Year  | Model    | Part                                       | Price     |
|--------|-------|----------|--|-----------|
| 255    | 58-62 | w/o Tilt | Horn Contact Upper Column Bearing Assembly | 19.95 Ea. |

## STEERING WHEEL SHROUDS



| Part # | Year  | Model  | Part                     | Price      |
|--------|-------|--------|--------------------------|------------|
| 11948  | 69-70 | Impala | Center Shroud Black      | 89.95 Ea.  |
| 11949  | 69-70 | Impala | Center Shroud Cherrywood | 109.95 Ea. |
| 15320  | 69-70 | Impala | Center Shroud Dk Blue    | 69.95 Ea.  |
| 15321  | 69-70 | Impala | Center Shroud Dk Green   | 69.95 Ea.  |
| 15322  | 69-70 | Impala | Center Shroud Red        | 69.95 Ea.  |

## WOOD WHEEL HUBS



| Part # | Year  | Model | Part               | Price     |
|--------|-------|-------|--------------------|-----------|
| 11951  | 67-68 | All   | Steering Wheel Hub | 51.95 Ea. |
| 11952  | 69    | All   | Steering Wheel Hub | 51.95 Ea. |

## WOOD WHEEL MOUNTING KITS



| Part # | Year  | Model | Part                    | Price     |
|--------|-------|-------|-------------------------|-----------|
| 11950  | 67-69 | All   | Wood Wheel Mounting Kit | 29.95 Kit |

## SHIFT LEVERS & KNOBS



| Part # | Year  | Model           | Part                    | Price     |
|--------|-------|-----------------|-------------------------|-----------|
| 6048   | 59-66 | Automatic       | Gear Shift Lever        | 30.95 Ea. |
| 6048   | 59-65 | 3-Spd w/o Tilt  | Gear Shift Lever        | 30.95 Ea. |
| 15345  | 61-64 | All             | Gear Shift Lever & Knob | 35.95 Ea. |
| 12933  | 58    | w/ Automatic    | Gear Shift Lever & Knob | 29.95 Ea. |
| 5809   | 59-65 | Automatic/3-Spd | Gear Shift Knob         | 9.95 Ea.  |

★ = special order non-stocking item, please allow 4-6 weeks for delivery.

② = truck freight (call for shipping quote)

① = add \$8.95 handling per item

② = add \$16.95 handling per item

# Steering Column Parts

## STEERING WHEELS



12854



12855



11946



15315

| Part # | Year  | Model     | Part                        | Price      |
|--------|-------|-----------|-----------------------------|------------|
| 12854  | 62    | Impala    | Steering Wheel Black        | 199.95 Ea. |
| 13157  | 62    | Impala SS | Steering Wheel Black        | 199.95 Ea. |
| 12855  | 63    | Impala    | Steering Wheel Black        | 199.95 Ea. |
| 11946  | 68    | Impala    | Deluxe Steering Wheel       | 239.95 Ea. |
| 15315  | 69    | All       | Rosewood Wheel Kit w/o Tilt | 369.95 Kit |
| 16238  | 69-70 | All       | 3-Spoke Steering Wheel      | 142.95 Ea. |

## STEERING COLUMN BEARINGS



5981



255

| Part # | Year  | Model            | Part                                       | Price      |
|--------|-------|------------------|--|------------|
| 5981   | 58-64 | All              | Lower Column Bearing                       | 28.95 Ea.  |
| 5981   | 65-66 | w/o 4-Spd & Tilt | Lower Column Bearing                       | 28.95 Ea.  |
| 8058   | 69-70 | All              | Lower Column Bearing Retainer              | 114.95 Ea. |
| 255    | 58-62 | w/o Tilt         | Upper Horn Contact/Column Bearing Assembly | 19.95 Ea.  |

## RAG JOINT REBUILD KITS



| Part # | Year  | Model | Part                  | Price     |
|--------|-------|-------|-----------------------|-----------|
| 8228   | 67-70 | All   | Rag Joint Rebuild Kit | 15.95 Kit |

## STEERING COLUMN SEALS



11905



11906



11915



11912



11913



13027

| Part # | Year  | Model     | Part                              | Price     |
|--------|-------|-----------|-----------------------------------|-----------|
| 11905  | 58    | Automatic | Steering Column Floor Seal        | 17.95 Ea. |
| 11906  | 58    | Standard  | Steering Column Floor Seal        | 16.95 Ea. |
| 11907  | 59-60 | Automatic | Steering Column Seal Under Hood   | 35.95 Ea. |
| 11908  | 59-60 | Standard  | Steering Column Seal Under Hood   | 45.95 Ea. |
| 11909  | 61-62 | Automatic | Steering Column Floor Seal        | 45.95 Ea. |
| 11910  | 61-62 | Standard  | Steering Column Floor Seal        | 45.95 Ea. |
| 11911  | 63-64 | Automatic | Steering Column Floor Seal        | 45.95 Ea. |
| 11912  | 63-64 | Standard  | Steering Column Floor Seal        | 45.95 Ea. |
| 15939  | 65-66 | All       | Lower Steering Column Seal        | 51.95 Ea. |
| 15893  | 67-68 | All       | Steering Column Floor Seal        | 45.95 Ea. |
| 11913  | 58    | Automatic | Steering Column Sponge Seal       | 8.95 Ea.  |
| 11914  | 58    | Standard  | Steering Column Sponge Seal       | 7.95 Ea.  |
| 13398  | 59-60 | All       | Steering Shaft Seal At Slip Joint | 11.95 Ea. |
| 11915  | 61    | All       | Steering Shaft Seal At Slip Joint | 19.95 Ea. |
| 11916  | 62-64 | All       | Steering Shaft Seal At Slip Joint | 21.95 Ea. |
| 11917  | 65-66 | All       | Steering Column Sponge Seal       | 12.95 Ea. |
| 11918  | 67-68 | All       | Steering Column Sponge Seal       | 12.95 Ea. |
| 11919  | 69-70 | All       | Steering Column Seal              | 12.95 Ea. |
| 13026  | 61-64 | Automatic | Under Hood Column Seal            | 29.95 Ea. |
| 13027  | 61-64 | Standard  | Under Hood Column Seal            | 29.95 Ea. |

## SHIFT LEVER GROMMETS



11920



11921



11922

| Part # | Year  | Model | Part  | Price    |
|--------|-------|-------|---|----------|
| 11920  | 58    | All   | Gear Shift Lever Grommet  | 4.00 Ea. |
| 11921  | 59-64 | All   | Gear Shift Lever Grommet  | 8.95 Ea. |
| 11922  | 59-60 | All   | Shift Lever Linkage Grommet (Automatic/1 Required; Standard/2 Required) | 2.00 Ea. |

# Steering Column Parts / Sill Plates / Sunvisor Parts / Suspension

## STEERING WHEEL DIVIDER TRIM

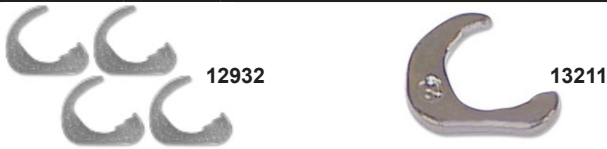

| Part # | Year  | Model  | Part                        | Price    |
|--------|-------|--------|-----------------------------|----------|
| 12932  | 58-60 | Impala | Steering Wheel Divider Trim | 8.95 Set |
| 13211  | 61-63 | Impala | Steering Wheel Divider Trim | 7.95 Ea. |

## SILL PLATES



| Part #  | Year  | Model | Part          | Price       |
|---------|-------|-------|---------------|-------------|
| 11937 ① | 58    | 2-Dr  | Sill Plates   | 77.95 Pair  |
| 11938 ① | 59-60 | 2-Dr  | Sill Plates   | 145.95 Pair |
| 11939 ① | 61-64 | 2-Dr  | Sill Plates   | 59.95 Pair  |
| 15540 ① | 65-70 | 2-Dr  | Sill Plate LH | 39.95 Ea.   |
| 15541 ① | 65-70 | 2-Dr  | Sill Plate RH | 39.95 Ea.   |

## WIRE HARNESS SILL COVERS



| Part #  | Year | Model | Part                   | Price     |
|---------|------|-------|------------------------|-----------|
| 12955 ① | 58   | All   | Wire Harness Covers LH | 45.95 Ea. |
| 12956 ① | 58   | All   | Wire Harness Covers RH | 45.95 Ea. |

## PITMAN ARMS



| Part # | Year  | Model            | Part       | Price      |
|--------|-------|------------------|------------|------------|
| 16028  | 63-64 | w/Power Steering | Pitman Arm | 139.95 Ea. |

## BALL JOINTS



| Part # | Year  | Model | Part             | Price     |
|--------|-------|-------|------------------|-----------|
| 11955  | 58-70 | All   | Upper Ball Joint | 29.95 Ea. |
| 11956  | 58-70 | All   | Lower Ball Joint | 25.95 Ea. |

## SUNVISOR PARTS



| Part # | Year  | Model               | Part              | Price       |
|--------|-------|---------------------|-------------------|-------------|
| 11953  |       |                     | Sunvisor Brackets | 39.95 Pair  |
| 1217   | 58    | Hardtop/Sedan/Wagon | Sunvisor Brackets | 39.95 Pair  |
| 12978  | 58    | Convertible         | Sunvisor Brackets | 299.95 Pair |
| 11954  | 64-68 | Hardtop/Sedan/Wagon | Sunvisor Bracket  | 18.95 Ea.   |
| 11953  | 61-64 | Convertible         | Sunvisor Brackets | 189.95 Pair |
| 15349  | 59-63 | Hardtop/Sedan       | Sunvisor Brackets | 45.95 Pair  |
| 15765  | 64-68 | All                 | Sunvisor Sleeve   | 3.95 Ea.    |

## PRO-TOURING SUSPENSION KITS



CPP's new Pro-Touring Kits are the most complete packages on the market and offer the ultimate in performance upgrades to your car or truck for an affordable price. Our kits come in 4 different stages, from suspension only (Stage I & II) to full kits (Stage III & IV) including front and rear brake packages. Our kits are made in the USA with the quality you have come to expect from Classic Performance Products, Inc.

| Part #  | Year  | Model                        | Part                                | Price       |
|---------|-------|------------------------------|-------------------------------------|-------------|
| 16558★△ | 59-64 | All w/Single Rear Upper Arm  | Stage 1 Pro-Touring Suspension Kits | 1799.95 Kit |
| 16559★△ | 59-64 | All w/Double Rear Upper Arms | Stage 1 Pro-Touring Suspension Kits | 1899.95 Kit |
| 16560★△ | 59-64 | All w/Single Rear Upper Arm  | Stage 2 Pro-Touring Suspension Kits | 2159.95 Kit |
| 16561★△ | 59-64 | All w/Double Rear Upper Arms | Stage 2 Pro-Touring Suspension Kits | 2259.95 Kit |
| 16562★△ | 59-64 | All w/Single Rear Upper Arm  | Stage 3 Pro-Touring Suspension Kits | 3299.95 Kit |
| 16563★△ | 59-64 | All w/Double Rear Upper Arms | Stage 3 Pro-Touring Suspension Kits | 3399.95 Kit |
| 16564★△ | 59-64 | All w/Single Rear Upper Arm  | Stage 4 Pro-Touring Suspension Kits | 3799.95 Kit |
| 16565★△ | 59-64 | All w/Double Rear Upper Arms | Stage 4 Pro-Touring Suspension Kits | 3899.95 Kit |

## TIE ROD ENDS



| Part # | Year  | Model | Part              | Price     |
|--------|-------|-------|-------------------|-----------|
| 15942  | 58-62 | All   | Outer Tie Rod End | 28.95 Ea. |
| 11958  | 63-64 | All   | Outer Tie Rod End | 29.95 Ea. |
| 11959  | 65-68 | All   | Outer Tie Rod End | 20.95 Ea. |
| 11960  | 69-70 | All   | Outer Tie Rod End | 45.95 Ea. |
| 15792  | 58-64 | All   | Inner Tie Rod End | 32.95 Ea. |
| 11961  | 65-68 | All   | Inner Tie Rod End | 18.95 Ea. |
| 11962  | 69-70 | All   | Inner Tie Rod End | 45.95 Ea. |

★ = special order non-stocking item, please allow 4-6 weeks for delivery.  
 △ = add \$80.95 handling per item ① = add \$8.95 handling per item  
 ② = add \$8.95 handling per item

# Suspension

## TIE ROD END SLEEVES



11963



15743

| Part # | Year  | Model | Part                              | Price      |
|--------|-------|-------|-----------------------------------|------------|
| 15614  | 58-64 | All   | Tie Rod Adjustment Sleeve         | 12.95 Ea.  |
| 11963  | 65-70 | All   | Tie Rod Adjustment Sleeve         | 16.95 Ea.  |
| 15743  | 65-70 | All   | Billet Tie Rod Adjustment Sleeves | 80.95 Pair |

## CENTER LINKS



15520



15615

| Part # | Year  | Model               | Part                   | Price      |
|--------|-------|---------------------|------------------------|------------|
| 16231  | 58-62 | w/Standard Steering | Center Link            | 89.95 Ea.  |
| 15520  | 63-64 | w/Standard Steering | Center Link            | 90.95 Ea.  |
| 15539  | 65-66 | All                 | Center Link            | 139.95 Ea. |
| 16029  | 67-70 | All                 | Center Link            | 229.95 Ea. |
| 15615  | 58-64 | w/Standard Steering | Center Link Repair Kit | 39.95 Kit  |

## A-FRAME DUST SHIELDS



10000



10006

| Part # | Year  | Model | Part                 | Price      |
|--------|-------|-------|----------------------|------------|
| 10000  | 58    | All   | A-Frame Dust Shields | 11.95 Pair |
| 10001  | 59    | All   | A-Frame Dust Shields | 11.95 Pair |
| 10002  | 60    | All   | A-Frame Dust Shields | 11.95 Pair |
| 10003  | 61    | All   | A-Frame Dust Shields | 11.95 Pair |
| 10004  | 62-64 | All   | A-Frame Dust Shields | 11.95 Pair |
| 10005  | 65    | All   | A-Frame Dust Shields | 11.95 Pair |
| 10006  | 66    | All   | A-Frame Dust Shields | 11.95 Pair |
| 10007  | 67    | All   | A-Frame Dust Shields | 11.95 Pair |
| 10008  | 68-69 | All   | A-Frame Dust Shields | 16.95 Pair |
| 10009  | 70-72 | All   | A-Frame Dust Shields | 17.95 Pair |

## TUBULAR A-ARMS



13074



13075

| Part # | Year  | Model | Part                 | Price       |
|--------|-------|-------|----------------------|-------------|
| 13074  | 58-64 | All   | Upper Tubular A-Arms | 373.95 Pair |
| 13075  | 58-64 | All   | Lower Tubular A-Arms | 495.95 Pair |

## CONTROL ARM BUMPERS



11970



13195

| Part # | Year  | Model | Part                     | Price    |
|--------|-------|-------|--------------------------|----------|
| 11970  | 58-70 | All   | Upper Control Arm Bumper | 4.00 Ea. |
| 13195  | 58-64 | All   | Lower Control Arm Bumper | 6.95 Ea. |

## CONTROL ARM SHAFTS



15586



15587

| Part # | Year  | Model | Part                        | Price      |
|--------|-------|-------|-----------------------------|------------|
| 15586  | 58-64 | All   | Upper Control Shaft Kit     | 69.95 Pair |
| 15587  | 58-64 | All   | Lower Control Arm Shaft Kit | 69.95 Pair |

## FRONT SHOCKS



13388



2766

| Part # | Year  | Model | Part        | Price     |
|--------|-------|-------|-------------|-----------|
| 13388  | 58-64 | All   | Front Shock | 40.95 Ea. |
| 2766   | 65-70 | All   | Front Shock | 52.95 Ea. |

## FRONT COIL OVER CONVERSION KITS



4380

QA1 conical springs are designed so that the lower end sets on the coil-over shock and the upper end sets in the original spring bucket in the frame. This allows for the use of a longer and lighter spring for more stored energy, offering increased weight transfer. Greater durability is also achieved by locating the spring pressure in the frame and not on a single stud. The threaded aluminum body allows ride height adjustment and boasts an easy bolt-in installation. The system includes Promo Star coil-over shocks, specially designed conical springs and all mounting hardware.

| Part # | Year  | Model       | Part  | Price      |
|--------|-------|-------------|---|------------|
| 4381★  | 58-64 | Small Block | Front Coil Over Convertible Kit Double Adjustable | 699.95 Kit |
| 4510★  | 58-64 | Big Block   | Front Coil Over Convertible Kit Double Adjustable | 699.95 Kit |

## IDLER ARMS



15613



11964



11965



11966

| Part # | Year  | Model | Part      | Price      |
|--------|-------|-------|-----------|------------|
| 15613  | 58-60 | All   | Idler Arm | 69.95 Ea.  |
| 11964  | 61-64 | All   | Idler Arm | 59.95 Ea.  |
| 11965  | 65-66 | All   | Idler Arm | 109.95 Ea. |
| 11966  | 67-70 | All   | Idler Arm | 89.95 Ea.  |

★ = special order non-stocking item, please allow 4-6 weeks for delivery.

# Suspension

## CONTROL ARMS



| Part # | Year  | Model | Part               | Price       |
|--------|-------|-------|--------------------|-------------|
| 15631  | 58-64 | All   | Upper Control Arms | 373.95 Pair |
| 15632  | 58-64 | All   | Lower Control Arms | 495.95 Pair |

## FRONT SWAY BARS



| Part #  | Year  | Model | Part                  | Price      |
|---------|-------|-------|-----------------------|------------|
| 15260 ① | 58-64 | All   | Front Sway Bar 7/8"   | 189.95 Ea. |
| 15262 ① | 65-70 | All   | Front Sway Bar 1 1/8" | 169.95 Ea. |

## FRONT SUSPENSION BUSHINGS



| Part # | Year  | Model | Part   | Price      |
|--------|-------|-------|--|------------|
| 3750   | 58-64 | All   | Urethane Control Arm Bushings                    | 129.95 Set |
| 15342  | 65-70 | All   | Urethane Control Arm Bushings                    | 129.95 Set |
| 439    | 58-70 | All   | Upper A-Arm Bushings                             | 28.95 Set  |
| 442    | 58-64 | All   | Lower A-Arm Bushings                             | 32.95 Set  |
| 11967  | 65-70 | All   | Lower A-Arm Bushings                             | 16.95 Ea.  |
| 11968  | 58-64 | All   | Stabilizer Link Bushings<br>(2 Required Per Car) | 5.00 Set   |

## AXLE BEARINGS & BUMPERS



| Part # | Year  | Model     | Part                   | Price      |
|--------|-------|-----------|------------------------|------------|
| 12701  | 58-64 | All       | Axle Bearing           | 89.95 Ea.  |
| 12702  | 65    | W/10-Bolt | Axle Bearing           | 29.95 Ea.  |
| 12702  | 66-70 | All       | Axle Bearing           | 29.95 Ea.  |
| 1845   | 58-64 | All       | Pinion Seal            | 30.95 Ea.  |
| 12703  | 65-72 | All       | Pinion Seal            | 18.95 Ea.  |
| 15941  | 58-63 | All       | Rear Axle/Frame Bumper | 18.95 Ea.  |
| 16269  | 65-68 | All       | Rear Axle Bumpers      | 99.95 Pair |

## DRIVE SHAFT SUPPORT



| Part # | Year  | Model | Part                         | Price      |
|--------|-------|-------|------------------------------|------------|
| 15894  | 58-64 | All   | Driver Shaft Support Carrier | 119.95 Ea. |

## COIL SPRINGS

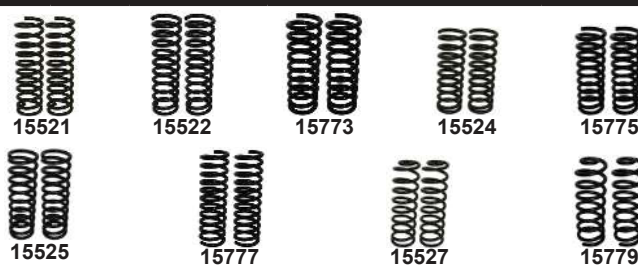

| Part # | Year  | Model       | Part                        | Price       |
|--------|-------|-------------|-----------------------------|-------------|
| 15521  | 58-64 | Small Block | Front Stock Height Springs  | 119.95 Pair |
| 15522  | 58-64 | Big Block   | Front Stock Height Springs  | 119.95 Pair |
| 15773  | 58-64 | Small Block | Front 1 1/2" Drop Springs   | 119.95 Pair |
| 15774  | 58-64 | Big Block   | Front 1 1/2" Drop Springs   | 119.95 Pair |
| 15523  | 65-70 | Small Block | Front Stock Height Springs  | 129.95 Pair |
| 15524  | 65-70 | Big Block   | Front Stock Hardtop Springs | 129.95 Pair |
| 15775  | 65-70 | Small Block | Front 1 1/2" Drop Springs   | 129.95 Pair |
| 15776  | 65-70 | Big Block   | Front 1 1/2" Drop Springs   | 139.95 Pair |
| 15525  | 58-64 | Non-Wagon   | Rear Stock Height Springs   | 129.95 Pair |
| 15526  | 58-64 | Wagon       | Rear Stock Height Springs   | 129.95 Pair |
| 15777  | 58-64 | Non-Wagon   | Rear 1 1/2" Drop Springs    | 119.95 Pair |
| 15778  | 58-64 | Wagon       | Rear 1 1/2" Drop Springs    | 139.95 Pair |
| 15527  | 65-70 | All         | Rear Stock Height Springs   | 129.95 Pair |
| 15779  | 65-70 | All         | Rear 1 1/2" Drop Springs    | 139.95 Pair |

## REAR SUSPENSION BUSHINGS



You will need a total of 8 bushings to rebuild the entire rear suspension.

| Part # | Year  | Model | Part   | Price      |
|--------|-------|-------|--|------------|
| 12971  | 58    | All   | Rear Suspension Bushing Kit                        | 169.95 Kit |
| 15348  | 59-64 | All   | Rear Stabilizer Bar Bushing<br>(2 Per Car)         | 12.95 Ea.  |
| 15255  | 59-64 | All   | Upper Trailing Arm Bushing<br>(2 Per Car)          | 12.95 Ea.  |
| 15255  | 59-64 | All   | Rear Bushing Of Lower Trailing<br>Arm (2 Per Car)  | 12.95 Ea.  |
| 15256  | 59-64 | All   | Front Bushing Of Lower Trailing<br>Arm (2 Per Car) | 12.95 Ea.  |
| 15351  | 65-70 | All   | Upper Trailing Arm Bushing<br>(4 Per Car)          | 10.95 Ea.  |
| 15255  | 65-70 | All   | Front Bushing Of Lower Trailing<br>Arm (2 Per Car) | 12.95 Ea.  |
| 15351  | 65-70 | All   | Rear Bushing Of Lower Trailing<br>Arm (2 Per Car)  | 10.95 Ea.  |

① = add \$8.95 handling per item

# Suspension

## RIDE PRO AND AIR POD SUSPENSIONS



Control airride equipped vehicle height with this affordable air suspension leveling system. This is the original RidePro system developed in the nineties. It still works exceptionally well if you like simplicity and manual control. The system utilizes a high quality solenoid air valve system manual switches, analog gauges and dependable electric components to provide simple, & reliable control.

| Part # | Year  | Model                             | Part   | Price       |
|--------|-------|-----------------------------------|--|-------------|
| 4070★  | 58-70 | All w/Air Ride                    | Ride Pro 3 Gallon Analog Control System                  | 1125.95 Kit |
| 4071★  | 58-70 | All w/Air Ride                    | Ride Pro 5 Gallon Analog Control System                  | 1325.95 Kit |
| 4072★  | 58-70 | All w/Air Ride                    | Ride Pro 5 Gallon w/Big Red Valves Analog Control System | 1725.95 Kit |
| 4073★  | 58-70 | All w/Air Ride                    | Ride Pro X 3 Gallon Control System                       | 1799.95 Kit |
| 4074★  | 58-70 | All w/Air Ride                    | Ride Pro X 5 Gallon Control System                       | 2099.95 Kit |
| 4075★  | 58-70 | All w/Air Ride                    | Ride Pro X 5 Gallon w/Big Red Valves Control System      | 2399.95 Kit |
| 4076★  | 58-70 | All w/Air Ride                    | Air Pod 3 Gallon Control System                          | 2199.95 Kit |
| 4077★  | 58-70 | All w/Air Ride                    | Air Pod 5 Gallon Control System                          | 2499.95 Kit |
| 4078★  | 58-70 | All w/Air Ride                    | Air Pod 5 Gallon w/Big Red Valves Control System         | 2799.95 Kit |
| 4079★  | 58-70 | All w/Ride Pro Or Air Pod Systems | Ride Pro Ride Hieght Sensor Upgrade                      | 499.95 Kit  |
| 4080★  | 58-70 | All w/3 Gallon Air Pod            | Air Pod 3 Gallon Cover                                   | 134.95 Ea.  |
| 4081★  | 58-70 | All w/5 Gallon Air Pod            | Air Pod 5 Gallon Cover                                   | 134.95 Ea.  |
| 15723★ | 58    | All                               | Ride Tech Air Suspension Kit                             | 4425.95 Kit |
| 15724★ | 59-64 | All                               | Ride Tech Air Suspension Kit                             | 4425.95 Kit |
| 15725★ | 65-66 | All                               | Ride Tech Air Suspension Kit                             | 4425.95 Kit |
| 15726★ | 67-70 | All                               | Ride Tech Air Suspension Kit                             | 4425.95 Kit |

## RIDE TECH COIL OVER SUSPENSION KITS

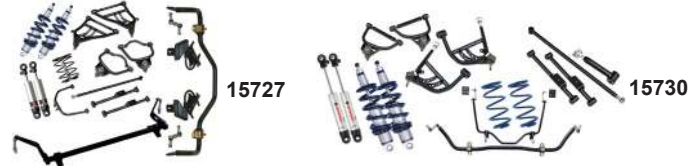

This CoilOver System is specifically designed for the 1958-70 Chevy "B" Body cars and includes everything needed to provide a lowered stance with dramatically improved handling and ride quality. The system contains front upper and lower StrongArms, front & rear MuscleBars, front HQ Series CoilOvers, rear StrongArms with upper wishbone, rear coil springs and rear HQ Series shocks. The benefit of buying a complete suspension system is that it takes all of the guesswork out when purchasing a new suspension. RideTech has spent hours collecting data to find a perfect spring rate and components for your vehicle's performance and ride quality.

| Part # | Year  | Model | Part                               | Price       |
|--------|-------|-------|------------------------------------|-------------|
| 15727★ | 58    | All   | Ride Tech Coil Over Suspension Kit | 4099.95 Kit |
| 15728★ | 59-64 | All   | Ride Tech Coil Over Suspension Kit | 4099.95 Kit |
| 15729★ | 65-66 | All   | Ride Tech Coil Over Suspension Kit | 4099.95 Kit |
| 15730★ | 67-70 | All   | Ride Tech Coil Over Suspension Kit | 4099.95 Kit |

## STREETGRIP SUSPENSION SYSTEM



Install a StreetGRIP suspension system on your full size 1958-1970 GM B-body and you will be rewarded with improved ride quality, handling, and a lowered stance. The range includes, Biscayne, Bel Air, Impala & El Camino. The complete kit has been designed with dual rate coilsprings, heavy duty swaybars and self-lubricating bushings. To help get the front of the car as low as possible, we provide a set of dropped spindles. Arguably, the most important part of the kit is the adjustable monotube shock absorbers. Specially calibrated to work with early B-bodies, they provide a giant technological leap forward with respect to both ride quality and handling. The shocks also come with RideTech's exclusive million and one-mile warranty.

| Part # | Year  | Model                        | Part                         | Price       |
|--------|-------|------------------------------|------------------------------|-------------|
| 16501★ | 58-64 | HT/Sedan/Conv w/ Small Block | Streetgrip Suspension System | 2500.95 Kit |
| 16502★ | 58-64 | HT/Sedan/Conv w/ Big Block   | Streetgrip Suspension System | 2500.95 Kit |



★ = special order non-stocking item, please allow 4-6 weeks for delivery.

# Suspension / Screw Sets

## REAR SWAY BARS



15261



15263

| Part #  | Year  | Model | Part             | Price      |
|---------|-------|-------|------------------|------------|
| 15261 ❶ | 58-64 | All   | Rear Sway Bar 1" | 179.95 Ea. |
| 15263 ❶ | 65-70 | All   | Rear Sway Bar 1" | 209.95 Ea. |

## LOWER REAR CONTROL ARMS



| Part # | Year  | Model | Part              | Price       |
|--------|-------|-------|-------------------|-------------|
| 15272  | 59-64 | All   | Rear Control Arms | 209.95 Pair |

## REAR SHOCKS



13389



15271

| Part # | Year  | Model | Part                   | Price      |
|--------|-------|-------|------------------------|------------|
| 13389  | 58-64 | All   | Rear Shock             | 40.95 Ea.  |
| 15271  | 59-64 | All   | Rear Shock Mount Bolts | 47.95 Pair |
| 13390  | 65-70 | All   | Rear Shock             | 49.95 Ea.  |

## TUBULAR TRAILING ARMS & BARS



15516



15517



15518

| Part # | Year  | Model | Part                                  | Price      |
|--------|-------|-------|---------------------------------------|------------|
| 15516★ | 59-64 | All   | Tubular Rear Trailing Arms w/2 Uppers | 429.95 Set |
| 15517★ | 59-64 | All   | Tubular Rear Trailing Arms w/1 Upper  | 349.95 Set |
| 15518★ | 59-64 | All   | Tubular Rear Trac Bar                 | 69.95 Ea.  |
| 15519★ | 65-70 | All   | Tubular Rear Trac Bar                 | 91.95 Ea.  |

## WHEEL BEARINGS



12704



12706



12708



12705



12707



12709



12710



12711



12712

| Part # | Year  | Model      | Part                | Price      |
|--------|-------|------------|---------------------|------------|
| 12704  | 58-60 | All        | Inner Wheel Bearing | 125.95 Ea. |
| 12706  | 61-68 | All        | Inner Wheel Bearing | 14.95 Ea.  |
| 12708  | 69-70 | All        | Inner Wheel Bearing | 18.95 Ea.  |
| 12705  | 58-60 | All        | Outer Wheel Bearing | 75.95 Ea.  |
| 12707  | 61-68 | All        | Outer Wheel Bearing | 14.95 Ea.  |
| 12709  | 69-70 | All        | Outer Wheel Bearing | 18.95 Ea.  |
| 12710  | 61-68 | Drum Brake | Wheel Seal          | 20.95 Ea.  |
| 12711  | 67    | Disc Brake | Wheel Seal          | 6.95 Ea.   |
| 12712  | 68    | Disc Brake | Wheel Seal          | 14.95 Ea.  |
| 12712  | 69-70 | All        | Wheel Seal          | 14.95 Ea.  |

## HUB DUST COVERS



| Part # | Year  | Model | Part           | Price    |
|--------|-------|-------|----------------|----------|
| 15944  | 61-68 | All   | Hub Dust Cover | 5.00 Ea. |

## UNDER HOOD & TRUNK HARDWARE KITS

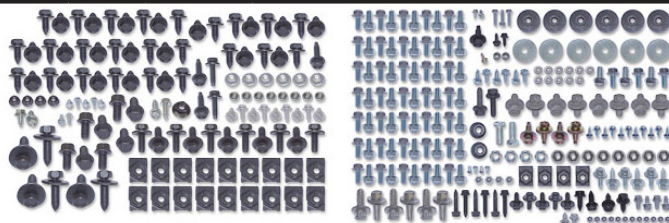

12788

12792

| Part # | Year  | Model | Part                        | Price      |
|--------|-------|-------|-----------------------------|------------|
| 12788  | 61-62 | All   | Under Hood & Trunk Hardware | 93.95 Kit  |
| 12789  | 63    | All   | Under Hood & Trunk Hardware | 130.95 Kit |
| 12790  | 64    | All   | Under Hood & Trunk Hardware | 134.95 Kit |
| 12791  | 65-66 | All   | Under Hood & Trunk Hardware | 168.95 Kit |
| 12792  | 67    | All   | Under Hood & Trunk Hardware | 133.95 Kit |
| 12793  | 69    | All   | Under Hood & Trunk Hardware | 179.95 Kit |
| 12794  | 70    | All   | Under Hood & Trunk Hardware | 153.95 Kit |

★ = special order non-stocking item, please allow 4-6 weeks for delivery.  
❶ = add \$8.95 handling per item

# Screw Sets

## INTERIOR SCREW SETS

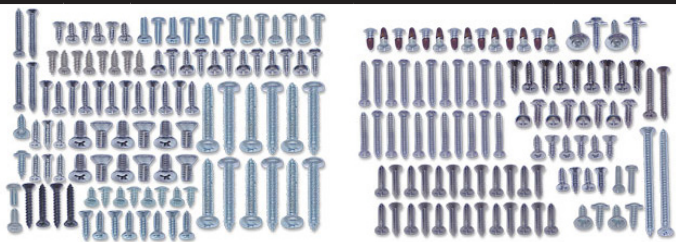

12752

12760

| Part # | Year | Model               | Part            | Price     |
|--------|------|---------------------|-----------------|-----------|
| 12749  | 62   | Belair 4-Dr Sedan   | Interior Screws | 27.95 Kit |
| 12750  | 64   | Belair 2-Dr Sedan   | Interior Screws | 26.95 Kit |
| 12751  | 65   | Belair 4-Door       | Interior Screws | 27.95 Kit |
| 12752  | 68   | Belair 4-Door       | Interior Screws | 38.95 Kit |
| 12753  | 58   | Impala 2-Dr Hardtop | Interior Screws | 39.95 Kit |
| 12754  | 59   | Impala 2-Dr Hardtop | Interior Screws | 35.95 Kit |
| 12755  | 60   | Impala 2-Dr Hardtop | Interior Screws | 38.95 Kit |
| 12756  | 61   | Impala 2-Dr Hardtop | Interior Screws | 30.95 Kit |
| 12757  | 62   | Impala 2-Dr Hardtop | Interior Screws | 32.95 Kit |
| 12758  | 63   | Impala 2-Dr Hardtop | Interior Screws | 30.95 Kit |
| 12759  | 64   | Impala 2-Dr Hardtop | Interior Screws | 30.95 Kit |
| 12760  | 65   | Impala 2-Dr Hardtop | Interior Screws | 35.95 Kit |
| 12761  | 66   | Impala 2-Door       | Interior Screws | 32.95 Kit |
| 12762  | 67   | Impala 2-Door       | Interior Screws | 25.95 Kit |
| 12763  | 68   | Impala 2-Dr Hardtop | Interior Screws | 40.95 Kit |
| 12764  | 69   | Impala 2-Dr Hardtop | Interior Screws | 38.95 Kit |
| 12765  | 70   | Impala 2-Door       | Interior Screws | 36.95 Kit |
| 12766  | 59   | Impala 4-Dr Hardtop | Interior Screws | 43.95 Kit |
| 12767  | 60   | Impala 4-Dr Hardtop | Interior Screws | 43.95 Kit |
| 12768  | 62   | Impala 4-Dr Hardtop | Interior Screws | 38.95 Kit |
| 12769  | 63   | Impala 4-Dr Sedan   | Interior Screws | 24.95 Kit |
| 12770  | 64   | Impala 4-Dr Hardtop | Interior Screws | 33.95 Kit |
| 12771  | 66   | Impala 4-Door       | Interior Screws | 24.95 Kit |
| 12772  | 67   | Impala 4-Dr Hardtop | Interior Screws | 29.95 Kit |
| 12773  | 69   | Impala 4-Dr Sedan   | Interior Screws | 30.95 Kit |
| 12774  | 70   | Impala 4-Door       | Interior Screws | 30.95 Kit |
| 12775  | 58   | Impala Convertible  | Interior Screws | 27.95 Kit |
| 12776  | 59   | Impala Convertible  | Interior Screws | 27.95 Kit |
| 12777  | 60   | Impala Convertible  | Interior Screws | 36.95 Kit |
| 12778  | 62   | Impala Convertible  | Interior Screws | 30.95 Kit |
| 12779  | 63   | Impala Convertible  | Interior Screws | 33.95 Kit |
| 12780  | 64   | Impala Convertible  | Interior Screws | 30.95 Kit |
| 12781  | 65   | Impala Convertible  | Interior Screws | 32.95 Kit |
| 12782  | 66   | Impala Convertible  | Interior Screws | 35.95 Kit |
| 12783  | 67   | Impala Convertible  | Interior Screws | 32.95 Kit |
| 12784  | 68   | Impala Convertible  | Interior Screws | 42.95 Kit |
| 12785  | 69   | Impala Convertible  | Interior Screws | 36.95 Kit |
| 12786  | 70   | Impala Convertible  | Interior Screws | 39.95 Kit |
| 12787  | 66   | Impala Wagon        | Interior Screws | 44.95 Kit |

## EXTERIOR SCREW SETS



| Part # | Year  | Model | Part                        | Price     |
|--------|-------|-------|-----------------------------|-----------|
| 12736  | 58    | All   | Exterior Screws             | 14.95 Kit |
| 12737  | 59    | All   | Exterior Screws             | 13.95 Kit |
| 12738  | 60    | All   | Exterior Screws             | 21.95 Kit |
| 12739  | 61    | All   | Exterior Screws             | 14.95 Kit |
| 12740  | 62    | All   | Exterior Screws             | 16.95 Kit |
| 12741  | 63    | All   | Exterior Screws             | 14.95 Kit |
| 12742  | 64    | All   | Exterior Screws             | 13.95 Kit |
| 12743  | 65    | All   | Exterior Screws             | 7.95 Kit  |
| 12744  | 66    | All   | Exterior Screws             | 10.95 Kit |
| 12745  | 67    | All   | Exterior Screws             | 14.95 Kit |
| 12746  | 68    | All   | Exterior Screws             | 23.95 Kit |
| 12747  | 69    | All   | Exterior Screws             | 24.95 Kit |
| 12748  | 70    | All   | Exterior Screws             | 29.95 Kit |
| 8255   | 61-70 | All   | Inner Fender J-Nuts & Bolts | 9.95 Kit  |

## VALVE COVER SCREW SETS



| Part # | Year  | Model   | Part                  | Price     |
|--------|-------|---------|-----------------------|-----------|
| 628    | 58-63 | 283/327 | Valve Cover Screw Set | 11.95 Set |
| 12027  | 58-63 | 348/409 | Valve Cover Screw Set | 14.95 Set |
| 12028  | 64    | All     | Valve Cover Screw Set | 9.95 Set  |

## INNER FENDER BOLT KIT



| Part # | Year  | Model | Part                  | Price    |
|--------|-------|-------|-----------------------|----------|
| 8255   | 61-70 | All   | Inner Fender Bolt Kit | 9.95 Kit |

# Transmission

## TRANSMISSION MOUNTS

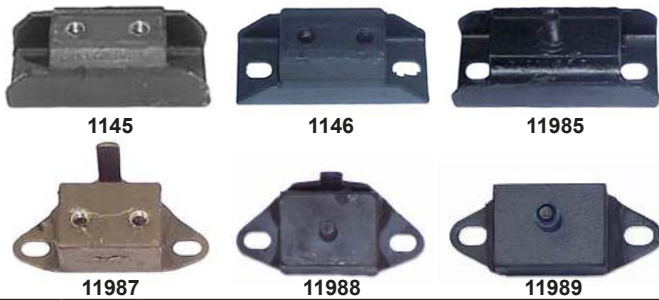

| Part # | Year  | Model                                      | Price     |
|--------|-------|--|-----------|
| 1145   | 58-59 | Impala 283 W/Standard                      | 11.95 Ea. |
| 11986  | 58-61 | All W/348 W/Aluminum Powerglide            | 4.00 Ea.  |
| 1145   | 58-61 | All W/348 W/Turboglide Or Standard         | 11.95 Ea. |
| 11986  | 58-68 | Impala 283 W/Aluminum Powerglide           | 4.95 Ea.  |
| 1145   | 60-68 | Impala 283 W/Standard                      | 11.95 Ea. |
| 11986  | 61-65 | All W/409 W/Aluminum Powerglide            | 4.95 Ea.  |
| 1145   | 61-65 | All W/409 W/Turboglide Or Standard         | 11.95 Ea. |
| 1146   | 62-69 | Biscayne/Belair 327 W/Automatic            | 11.95 Ea. |
| 1145   | 62-69 | Biscayne/Belair 327 W/Standard             | 11.95 Ea. |
| 1146   | 63-69 | Impala 327 W/Automatic                     | 11.95 Ea. |
| 1145   | 63-69 | Impala 327 W/Standard                      | 11.95 Ea. |
| 1146   | 65-67 | All w/ 427 W/Automatic                     | 11.95 Ea. |
| 1145   | 65-67 | All w/ 427 W/Standard                      | 11.95 Ea. |
| 1146   | 65-68 | Impala 283 W/Turbo                         | 11.95 Ea. |
| 1145   | 65-68 | All w/ 396                                 | 11.95 Ea. |
| 11986  | 66-67 | Caprice 283 W/Aluminum Powerglide          | 4.95 Ea.  |
| 1146   | 66-67 | Caprice 283 W/Turbo                        | 11.95 Ea. |
| 1146   | 66-69 | Caprice 327 All                            | 11.95 Ea. |
| 11985  | 66-70 | Biscayne/Belair 250 6-Cylinder W/Automatic | 8.95 Ea.  |
| 1145   | 66-70 | Biscayne/Belair 250 6-Cylinder W/Standard  | 11.95 Ea. |
| 1145   | 68    | Belair/Caprice 307 All                     | 11.95 Ea. |
| 11987  | 68-69 | All w/ 427 W/Automatic Or Standard         | 8.95 Ea.  |
| 11987  | 69    | All w/ 396                                 | 8.95 Ea.  |
| 11987  | 69-70 | Caprice 350 All                            | 8.95 Ea.  |
| 11988  | 69-70 | Biscayne/Belair/Impala 350 W/Powerglide    | 8.95 Ea.  |
| 11989  | 69-70 | Biscayne/Belair/Impala 350 W/Turboglide    | 8.95 Ea.  |
| 1146   | 69-70 | Biscayne/Belair/Impala 350 W/Standard      | 11.95 Ea. |
| 1146   | 70    | Biscayne/Belair 400 W/Automatic            | 11.95 Ea. |
| 1145   | 70    | Biscayne/Eblair 400 W/Standard             | 11.95 Ea. |
| 1145   | 70    | All w/ 454                                 | 11.95 Ea. |

## SHIFT LINKAGE

| Part # | Year  | Model                | Part          | Price     |
|--------|-------|----------------------|---------------|-----------|
| 15954  | 58-64 | Column Shift w/700R4 | Shift Linkage | 62.95 Ea. |
| 15955  | 65-70 | Column Shift w/700R4 | Shift Linkage | 79.95 Ea. |

## TRANSMISSION SHIFT INDICATORS



| Part # | Year  | Model           | Part                               | Price     |
|--------|-------|-----------------|------------------------------------|-----------|
| 10380  | 58    | All             | Transmission Indicator Illuminator | 20.95 Ea. |
| 10381  | 58    | Powerglide      | Transmission Indicator             | 42.95 Ea. |
| 10382  | 58    | Turboglide      | Transmission Indicator             | 42.95 Ea. |
| 10394  | 59-60 | Powerglide      | Transmission Indicator             | 32.95 Ea. |
| 10395  | 59-60 | Turboglide      | Transmission Indicator             | 32.95 Ea. |
| 10401  | 61-62 | Powerglide      | Transmission Indicator             | 30.95 Ea. |
| 10402  | 61-62 | Turboglide      | Transmission Indicator             | 30.95 Ea. |
| 7257   | 64    | Automatic       | Transmission Indicator Housing     | 11.95 Ea. |
| 7258   | 64    | Powerglide      | Transmission Indicator             | 8.95 Ea.  |
| 8397   | 63-64 | W/Turbo 350/400 | Shift Indicator Lens               | 19.95 Ea  |
| 8398   | 63-64 | w/Overdrive     | Shift Indicator Lens               | 19.95 Ea  |
| 16329  | 67    | w/Turbo 350/400 | Shift Indicator Lens               | 19.95 Ea  |
| 16330  | 67    | w/Overdrive     | Shift Indicator Lens               | 19.95 Ea  |

## TRANSMISSION LINES



| Part #             | Year  | Model                | Part                           | Price     |
|--------------------|-------|----------------------|--------------------------------|-----------|
| 11979 <sup>①</sup> | 58    | V8 Turboglide        | Transmission Line (Except 348) | 51.95 Set |
| 11977 <sup>②</sup> | 58    | 348 Powerglide       | Transmission Line              | 51.95 Set |
| 11978 <sup>②</sup> | 58    | 348 Turboglide       | Transmission Line              | 51.95 Set |
| 11979 <sup>②</sup> | 59-61 | V8 Turboglide        | Transmission Line              | 51.95 Set |
| 11980 <sup>②</sup> | 59-62 | V8 Cast Iron Pg      | Transmission Line              | 51.95 Set |
| 11981 <sup>②</sup> | 62-64 | V8 Aluminum Pg       | Transmission Line              | 51.95 Set |
| 15952 <sup>②</sup> | 59-64 | W/700R4              | Transmission Cooling Lines     | 75.95 Set |
| 11982 <sup>②</sup> | 65-66 | Small Block          | Transmission Line              | 51.95 Set |
| 11983 <sup>②</sup> | 65-66 | Big Block Powerglide | Transmission Line              | 51.95 Set |
| 11984 <sup>②</sup> | 65-66 | Big Block T400       | Transmission Line              | 51.95 Set |
| 15953 <sup>②</sup> | 65-70 | W/700R4              | Transmission Cooling Lines     | 65.95 Set |

① = add \$8.95 handling per item  
 ② = add \$16.95 handling per item

# Transmission

## SPEEDOMETER GEARS

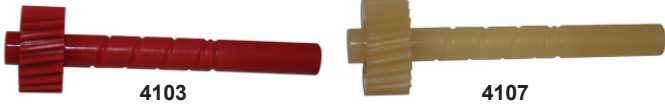

| Part # | Year  | Model      | Part                   | Price     |
|--------|-------|------------|------------------------|-----------|
| 4103   | 58-60 | Powerglide | Red Gear (21 Teeth)    | 11.95 Ea. |
| 4104   | 58-60 | Powerglide | Blue Gear (20 Teeth)   | 11.95 Ea. |
| 4105   | 58-60 | Powerglide | Green Gear (22 Teeth)  | 11.95 Ea. |
| 4106   | 58-60 | Powerglide | Yellow Gear (24 Teeth) | 11.95 Ea. |
| 4107   | 58-60 | Powerglide | Nylon Gear (25 Teeth)  | 11.95 Ea. |
| 4108   | 58-60 | Powerglide | Brown Gear (18 Teeth)  | 11.95 Ea. |

## TRANSMISSION CROSSMEMBERS

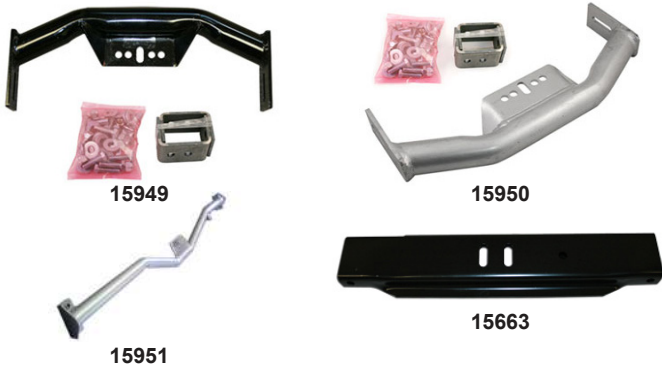

| Part # | Year  | Model      | Part                             | Price      |
|--------|-------|------------|----------------------------------|------------|
| 15949  | 58    | w/700R4    | Transmission Crossmember         | 109.95 Ea. |
| 15950  | 59-64 | w/700R4    | Transmission Crossmember         | 109.95 Ea. |
| 15951  | 65-70 | w/700R4    | Transmission Crossmember         | 159.95 Ea. |
| 15663  | 61-64 | Powerglide | Transmission Crossmember Support | 74.95 Ea.  |

## FLOOR SHIFTER CONVERSIONS

| Part # | Year  | Model                      | Part                   | Price      |
|--------|-------|----------------------------|------------------------|------------|
| 16325  | 64    | Impala w/Turbo 350/400     | Shifter Conversion Kit | 175.95 Kit |
| 16326  | 64    | Impala w/200-4R/700R4/4L60 | Shifter Conversion Kit | 175.95 Kit |
| 16327  | 65    | Impala w/200-4R/700R4/4L60 | Shifter Conversion Kit | 59.95 Kit  |
| 16328  | 66-67 | Impala w/200-4R/700R4/4L60 | Shifter Conversion Kit | 59.95 Kit  |

## TRANSMISSION TORQUE CONVERTER LOCKUP KIT



Our lockup kit allows you to install a 700R4 or 200R4 without any computer. This is a complete external kit. No brake switches or vacuum switches are needed. Our kit allows lockup only in fourth gear which eliminates most converter shudder. This kit works with all 700R4/200R4 with a square connector plug.

**NOTE: This kit will not work with 4L60E or 4L80E transmissions!**

| Part # | Year  | Model                  | Price     |
|--------|-------|------------------------|-----------|
| 3694   | 58-70 | All w/ 200R4 And 700R4 | 69.95 Kit |

## NEUTRAL SAFETY SWITCHES

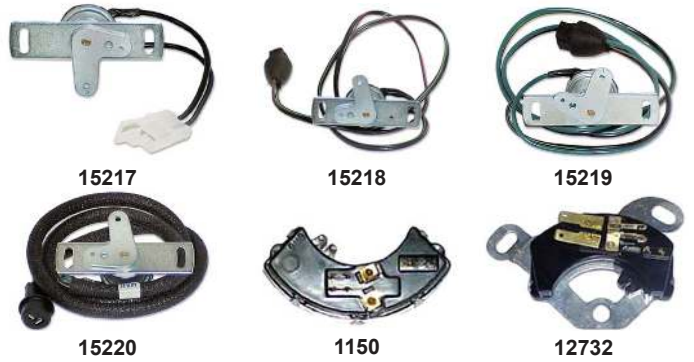

| Part # | Year  | Model                                | Part                  | Price     |
|--------|-------|--------------------------------------|-----------------------|-----------|
| 15217  | 59-62 | 4-Speed                              | Backup Light Switch   | 65.95 Ea. |
| 15218  | 63    | 4-Speed                              | Backup Light Switch   | 65.95 Ea. |
| 15219  | 64    | 4-Speed                              | Backup Light Switch   | 65.95 Ea. |
| 15220  | 65-67 | 4-Speed                              | Backup Light Switch   | 65.95 Ea. |
| 15221  | 68    | 4-Speed                              | Backup Light Switch   | 65.95 Ea. |
| 15628  | 69-70 | 3-Speed                              | Backup Light Switch   | 49.95 Ea. |
| 15629  | 64    | Impala SS w/Powerglide Console Shift | Neutral Safety Switch | 60.95 Ea. |
| 1150   | 65-66 | w/o Console                          | Neutral Safety Switch | 15.95 Ea. |
| 12732  | 65-67 | w/Console                            | Neutral Safety Switch | 59.95 Ea. |
| 15979  | 65-68 | Console w/Powerglide                 | Neutral Safety Switch | 64.95 Ea. |

## TRAFFIC LIGHT VIEWERS



Reproduction of original! Used to allow driver to see traffic lights without view being obstructed by the roof overhang.

| Part # | Year | Model | Part                 | Price     |
|--------|------|-------|----------------------|-----------|
| 320    | 58   | All   | Traffic Light Viewer | 59.95 Ea. |

① = add \$8.95 handling per item

# Tissue Dispenser / Tilt / Tools / Trunk Parts

## TISSUE DISPENSERS



| Part # | Year  | Model | Part             | Price     |
|--------|-------|-------|------------------|-----------|
| 1516   | 58    | All   | Tissue Dispenser | 89.95 Ea. |
| 11971  | 59-60 | All   | Tissue Dispenser | 99.95 Ea. |
| 11972  | 61    | All   | Tissue Dispenser | 99.95 Ea. |
| 11973  | 62    | All   | Tissue Dispenser | 99.95 Ea. |
| 11974  | 63    | All   | Tissue Dispenser | 95.95 Ea. |
| 11975  | 64-65 | All   | Tissue Dispenser | 95.95 Ea. |
| 11976  | 66-67 | All   | Tissue Dispenser | 95.95 Ea. |

## TILT STEERING RELEASE LEVER



| Part # | Year  | Model             | Part               | Price     |
|--------|-------|-------------------|--------------------|-----------|
| 5728   | 63-65 | All               | Tilt Release Lever | 16.95 Ea. |
| 5728   | 66    | Impala            | Tilt Release Lever | 16.95 Ea. |
| 12022  | 66    | Impala SS/Caprice | Tilt Release Lever | 28.95 Ea. |
| 12023  | 67    | All               | Tilt Release Lever | 25.95 Ea. |
| 12024  | 68-70 | All               | Tilt Release Lever | 25.95 Ea. |

## THE NUT JOB



A great detail tool used for cleaning and polishing lug nuts and recessed areas like the gap around door and hoods.

| Part # | Model    | Part        | Price     |
|--------|----------|-------------|-----------|
| 4390   | All Cars | The Nut Job | 15.95 Ea. |

## CUSTOM TRUNK PANEL KIT



| Part # | Year  | Model                         | Part                      | Price      |
|--------|-------|-------------------------------|---------------------------|------------|
| 16579  | 62-64 | Hardtop/Convertible/<br>Sedan | Custom Trunk<br>Panel Kit | 199.95 Kit |

## TRUNK LOCKS



| Part # | Year  | Model | Part                      | Price     |
|--------|-------|-------|---------------------------|-----------|
| 1718   | 58    | All   | Trunk Lock w/Keys         | 23.95 Ea. |
| 11248  | 59    | All   | Trunk Lock w/Keys         | 35.95 Ea. |
| 11249  | 60-68 | All   | Trunk Lock w/Keys         | 20.95 Ea. |
| 1073   | 58-67 | All   | Trunk Lock Shaft & Spring | 3.00 Kit  |
| 13068  | 68-70 | All   | Trunk Lock Shaft & Spring | 3.00 Kit  |

## TRUNK HINGES & LATCHES

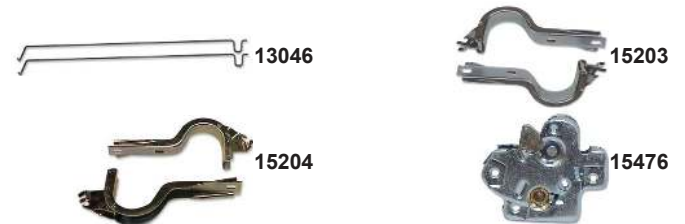

| Part # | Year  | Model           | Part                | Price       |
|--------|-------|-----------------|---------------------|-------------|
| 13046  | 60-64 | Non-Convertible | Trunk Hinge Springs | 79.95 Pair  |
| 15203  | 61-64 | Hardtop/Sedan   | Trunk Lid Hinges    | 79.95 Pair  |
| 15204  | 61-64 | Convertible     | Trunk Lid Hinges    | 149.95 Pair |
| 15476  | 62-70 | All             | Trunk Latch         | 39.95 Ea.   |
| 16059  | 59-70 | All             | Trunk Lid Catch     | 35.95 Ea.   |

## BILLET ALUMINUM TRUNK HINGES



| Part # | Year  | Model | Part                                  | Price       |
|--------|-------|-------|---------------------------------------|-------------|
| 16253★ | 60-62 | All   | Billet Alum Trunk Hinges/<br>Polished | 439.95 Pair |
| 16255★ | 60-62 | All   | Billet Alum Trunk Hinges/Black        | 459.95 Pair |
| 16256★ | 63-64 | All   | Billet Alum Trunk Hinges/<br>Polished | 439.95 Pair |
| 16258★ | 63-64 | All   | Billet Alum Trunk Hinges/Black        | 459.95 Pair |

## TRUNK CATCH LOCK STRIKER

| Part # | Year | Model            | Part                     | Price     |
|--------|------|------------------|--------------------------|-----------|
| 16517  | 62   | All Except Wagon | Trunk Catch Lock Striker | 39.95 Ea. |

## TRUNK RUBBER BUMPERS



| Part # | Year  | Model | Part          | Price     |
|--------|-------|-------|---------------|-----------|
| 11689  | 58-64 | All   | Trunk Bumper  | 1.00 Ea.  |
| 11690  | 65-70 | All   | Trunk Bumpers | 4.00 Pair |

★ = special order non-stocking item, please allow 4-6 weeks for delivery.

# Trunk Parts / Turn Signals

## TRUNK RUBBER SEALS



12011



1599

| Part # | Year  | Model | Part                      | Price     |
|--------|-------|-------|---------------------------|-----------|
| 12011  | 58    | All   | Trunk Rubber              | 23.95 Ea. |
| 12012  | 59-60 | All   | Trunk Rubber              | 23.95 Ea. |
| 12013  | 61-64 | All   | Trunk Rubber              | 23.95 Ea. |
| 12014  | 65-76 | All   | Trunk Rubber              | 23.95 Ea. |
| 1599   | 55-70 | All   | 3-M Super Rubber Adhesive | 15.95 Ea. |

## TRUNK MATS

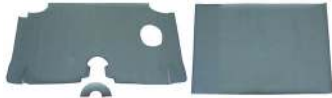

11999

| Part #  | Year  | Model               | Part      | Price     |
|---------|-------|---------------------|-----------|-----------|
| 11999 ❶ | 59-60 | Hardtop/Convertible | Trunk Mat | 85.95 Ea. |
| 12000 ❶ | 61    | Hardtop             | Trunk Mat | 47.95 Ea. |
| 12001 ❶ | 61    | Convertible         | Trunk Mat | 59.95 Ea. |
| 12002 ❶ | 62-64 | Hardtop             | Trunk Mat | 47.95 Ea. |
| 12003 ❶ | 62-64 | Convertible         | Trunk Mat | 59.95 Ea. |
| 12004 ❶ | 65    | Hardtop             | Trunk Mat | 59.95 Ea. |
| 12005 ❶ | 65    | Convertible         | Trunk Mat | 59.95 Ea. |
| 12006 ❶ | 66-67 | Hardtop             | Trunk Mat | 59.95 Ea. |
| 12007 ❶ | 66-67 | Convertible         | Trunk Mat | 59.95 Ea. |
| 12008 ❶ | 68    | Hardtop             | Trunk Mat | 48.95 Ea. |
| 12009 ❶ | 68    | Convertible         | Trunk Mat | 48.95 Ea. |
| 12010 ❶ | 69-70 | Hardtop             | Trunk Mat | 48.95 Ea. |

## TRUNK CARDBOARD PANELS



11991



11992



11996

| Part #  | Year  | Model        | Part                 | Price     |
|---------|-------|--------------|----------------------|-----------|
| 11990 ❷ | 58    | 2-Dr Hardtop | Trunk Cardboard      | 29.95 Ea. |
| 15199 ❷ | 58    | Sedan        | Trunk Cardboard      | 18.95 Ea. |
| 11991 ❷ | 62-64 | 2-Dr Hardtop | Trunk Cardboard      | 49.95 Ea. |
| 11992 ❷ | 65-67 | 2-Dr Hardtop | Trunk Cardboard      | 29.95 Ea. |
| 11993 ❷ | 58    | 2-Dr Hardtop | Side Filler Panel    | 35.95 Ea. |
| 11996 ❷ | 58    | Convertible  | Side Filler Panel LH | 29.95 Ea. |

## TURN SIGNAL MECHANISM PIVOT BOLT



| Part # | Year  | Model | Part                             | Price    |
|--------|-------|-------|----------------------------------|----------|
| 6063   | 59-62 | All   | Turn Signal Mechanism Pivot Bolt | 4.00 Ea. |

## TURN SIGNAL CAMS



6064



6065



5732



15200



250



5731



12016



12017

| Part # | Year  | Model    | Part                         | Price     |
|--------|-------|----------|------------------------------|-----------|
| 6064   | 63    | All      | Turn Signal Switch Lever Cam | 5.00 Ea.  |
| 6065   | 64-66 | All      | Turn Signal Switch Lever Cam | 5.00 Ea.  |
| 5732   | 67-68 | All      | Turn Signal Mechanism Cam    | 8.95 Ea.  |
| 15200  | 69-75 | All      | Turn Signal Mechanism Cam    | 7.95 Ea.  |
| 250    | 58    | All      | Turn Signal Cancelling Cam   | 6.95 Ea.  |
| 5731   | 59-66 | w/o Tilt | Turn Signal Cancelling Cam   | 8.95 Ea.  |
| 12016  | 63-66 | w/Tilt   | Turn Signal Cancelling Cam   | 12.95 Ea. |
| 12017  | 67-68 | w/Tilt   | Turn Signal Cancelling Cam   | 14.95 Ea. |

## TURN SIGNAL SWITCHES



6925



5807



13371



12026



13015

| Part # | Year  | Model    | Part                                  | Price     |
|--------|-------|----------|---------------------------------------|-----------|
| 3730   | 58    | All      | Turn Signal Switch                    | 25.95 Ea. |
| 6925   | 59-62 | All      | Turn Signal Switch                    | 23.95 Ea. |
| 5807   | 63    | w/o Tilt | Turn Signal Switch                    | 65.95 Ea. |
| 5808   | 64-66 | w/o Tilt | Turn Signal Switch                    | 65.95 Ea. |
| 13371  | 63-66 | w/Tilt   | Turn Signal Switch                    | 69.95 Ea. |
| 15346  | 69-70 | All      | Turn Signal Switch                    | 42.95 Ea. |
| 12026  | 67-68 | w/o Tilt | Turn Signal Switch w/Delco Type       | 49.95 Ea. |
| 13015  | 61-66 | All      | Turn Signal Light Switch Cover        | 45.95 Ea. |
| 15981  | 59-60 | All      | Turn Signal Switch Cable Short (19")  | 19.95 Ea. |
| 15982  | 59-62 | All      | Turn Signal Switch Cable Long (23.5") | 19.95 Ea. |

❶ = add \$8.95 handling per item

❷ = add \$16.95 handling per item

# Turn Signals / Wheels / Window Parts

## TURN SIGNAL MECHANISM REPAIR KITS



| Part # | Year  | Model | Part                           | Price     |
|--------|-------|-------|--------------------------------|-----------|
| 6061   | 59-60 | All   | Turn Signal Mechism Repair Kit | 35.95 Kit |
| 6062   | 61-62 | All   | Turn Signal Mechism Repair Kit | 35.95 Kit |

## TURN SIGNAL LEVERS



| Part # | Year  | Model                    | Part              | Price     |
|--------|-------|--------------------------|-------------------|-----------|
| 257    | 58    | All                      | Turn Signal Lever | 12.95 Ea. |
| 6493   | 59-60 | All                      | Turn Signal Lever | 16.95 Ea. |
| 5725   | 61-62 | All                      | Turn Signal Lever | 15.95 Ea. |
| 5726   | 63-66 | Without Tilt             | Turn Signal Lever | 15.95 Ea. |
| 12018  | 66    | Impala/Caprice w/o Tilt  | Turn Signal Lever | 28.95 Ea. |
| 5725   | 63-65 | w/Tilt                   | Turn Signal Lever | 15.95 Ea. |
| 5725   | 66    | Impala w/Tilt            | Turn Signal Lever | 15.95 Ea. |
| 12019  | 66    | Impala SS/Caprice w/Tilt | Turn Signal Lever | 28.95 Ea. |
| 12020  | 67    | w/Tilt                   | Turn Signal Lever | 24.95 Ea. |
| 12021  | 68-70 | All                      | Turn Signal Lever | 24.95 Ea. |

## WHEEL SPINNER EMBLEMS



| Part # | Year  | Model     | Part                        | Price     |
|--------|-------|-----------|-----------------------------|-----------|
| 1151   | 58    | Impala    | Wheel Cover Emblems         | 50.95 Set |
| 12048  | 59-60 | Impala    | Wheel Spinner Emblem Black  | 45.95 Ea. |
| 12049  | 59-60 | Impala    | Wheel Spinner Emblem Silver | 45.95 Ea. |
| 12050  | 61    | Impala    | Wheel Cover Emblem          | 49.95 Ea. |
| 12051  | 62    | Impala    | Wheel Cover Emblem          | 35.95 Ea. |
| 12052  | 63    | Impala SS | Wheel Cover Emblem          | 59.95 Ea. |
| 12053  | 64    | Impala SS | Wheel Cover Emblem          | 49.95 Ea. |
| 12054  | 65-66 | Impala SS | Wheel Cover Emblem          | 49.95 Ea. |
| 12055  | 65-66 | Caprice   | Wheel Cover Emblem          | 49.95 Ea. |
| 12056  | 67    | Impala SS | Wheel Cover Emblem          | 58.95 Ea. |
| 12057  | 69-70 | All       | Wheel Cover Emblem          | 31.95 Ea. |
| 12047  | 69    | All       | Finned Wheel Cover Emblem   | 69.95 Ea. |

## WHEEL SPINNER EMBLEMS



| Part # | Year  | Model                        | Part                     | Price      |
|--------|-------|------------------------------|--------------------------|------------|
| 12039  | 58    | Impala                       | Wheel Spinner Set        | 159.95 Set |
| 12040  | 59-60 | Impala                       | Wheel Spinner Set Black  | 349.95 Set |
| 12041  | 59-60 | Impala                       | Wheel Spinner Set Silver | 349.95 Set |
| 12042  | 61    | Impala SS                    | Wheel Spinner Set        | 339.95 Set |
| 12043  | 62    | Impala SS Except w/Wire Caps | Wheel Spinner Set        | 339.95 Set |
| 12044  | 62-63 | Impala SS w/Wire Caps        | Wheel Spinner Set        | 209.95 Set |
| 12045  | 65-66 | Impala SS                    | Wheel Spinner Set        | 349.95 Set |
| 12046  | 65-66 | Caprice                      | Wheel Spinner Set        | 349.95 Set |

## HUB CAP PARTS



| Part # | Year | Model  | Part               | Price     |
|--------|------|--------|--------------------|-----------|
| 12944  | 58   | Impala | Hub Cap Detail Kit | 65.95 Kit |

## LOWER WINDOW FRAME CHANNELS

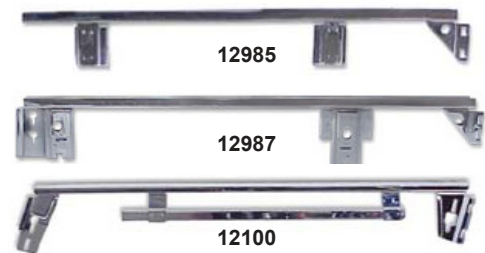

| Part # | Year  | Model               | Part                  | Price     |
|--------|-------|---------------------|-----------------------|-----------|
| 12985  | 58    | Hardtop/Convertible | Lower Window Frame LH | 79.95 Ea. |
| 12986  | 58    | Hardtop/Convertible | Lower Window Frame RH | 79.95 Ea. |
| 12987  | 59-60 | Hardtop/Convertible | Lower Window Frame LH | 79.95 Ea. |
| 12988  | 59-60 | Hardtop/Convertible | Lower Window Frame RH | 79.95 Ea. |
| 12100  | 61-64 | Hardtop/Convertible | Lower Window Frame LH | 59.95 Ea. |
| 12101  | 61-64 | Hardtop/Convertible | Lower Window Frame RH | 59.95 Ea. |

## Window Parts

### WINDOW REGULATORS



13083

| Part # | Year  | Model                    | Part                                | Price     |
|--------|-------|--------------------------|-------------------------------------|-----------|
| 13082  | 61-64 | 2-Dr Hardtop/Convertible | Door Window Regulator LH            | 89.95 Ea  |
| 13083  | 61-64 | 2-Dr Hardtop/Convertible | Door Window Regulator RH            | 89.95 Ea  |
| 16311  | 65-66 | 2-Dr Hardtop/Convertible | Window Regulator LH                 | 119.95 Ea |
| 16312  | 65-66 | 2-Dr Hardtop/Convertible | Window Regulator RH                 | 119.95 Ea |
| 16313  | 65-66 | 2-Dr Hardtop/Convertible | Quarter Window Quarter Regulator LH | 89.95 Ea  |
| 16314  | 65-66 | 2-Dr Hardtop/Convertible | Quarter Window Quarter Regulator RH | 89.95 Ea  |

### VENT WINDOW RUBBER



12030

12031

15126

| Part # | Year  | Model                      | Part               | Price      |
|--------|-------|----------------------------|--------------------|------------|
| 12029  | 58    | Impala Hardtop/Convertible | Vent Window Rubber | 109.95 Set |
| 15207  | 58    | Belair Hardtop             | Vent Window Rubber | 179.95 Set |
| 16030  | 58    | 4-Dr Hardtop               | Vent Window Rubber | 179.95 Set |
| 15208  | 58    | 2/4-Door Sedan             | Vent Window Rubber | 179.95 Set |
| 15209  | 58    | Wagon                      | Vent Window Rubber | 179.95 Set |
| 12030  | 59-60 | Hardtop/Convertible        | Vent Window Rubber | 59.95 Set  |
| 15210  | 59    | 2/4-Dr Sedan/Wagon         | Vent Window Rubber | 179.95 Set |
| 15211  | 60    | 2/4-Dr Sedan/Wagon         | Vent Window Rubber | 179.95 Set |
| 12031  | 61-62 | Hardtop/Convertible        | Vent Window Rubber | 59.95 Set  |
| 15212  | 61-62 | 2/4-Dr Sedan/Wagon         | Vent Window Rubber | 199.95 Set |
| 12032  | 63-64 | Hardtop/Convertible        | Vent Window Rubber | 55.95 Set  |
| 15213  | 63-64 | 2/4-Dr Sedan/Wagon         | Vent Window Rubber | 75.95 Set  |
| 15126  | 65-68 | Hardtop/Convertible        | Vent Window Rubber | 59.95 Set  |
| 15214  | 65-68 | 2/4-Dr Sedan/Wagon         | Vent Window Rubber | 199.95 Set |

### DOOR WINDOW ADJUSTMENT HARDWARE

| Part # | Year  | Model               | Part                            | Price      |
|--------|-------|---------------------|---------------------------------|------------|
| 16277  | 59-60 | Hardtop/Convertible | Door Window Adjustment Hardware | 17.95 Pair |
| 16068  | 61-64 | Hardtop/Convertible | Door Window Adjustment Hardware | 13.95 Pair |

### VENT WINDOW HANDLES & REGULATORS



12936

12862

12062

12063

220

15181

| Part # | Year  | Model           | Part                     | Price      |
|--------|-------|-----------------|--------------------------|------------|
| 12936  | 58    | Impala          | Vent Window Handle       | 22.95 Ea.  |
| 12862  | 59-60 | Impala          | Vent Window Handle       | 12.95 Ea.  |
| 12062  | 58-60 | Biscayne/Belair | Vent Window Handle       | 11.95 Ea.  |
| 13148  | 61-64 | Impala          | Vent Window Handle       | 12.95 Ea.  |
| 12062  | 61-64 | Biscayne        | Vent Window Handle       | 11.95 Ea.  |
| 12063  | 65-66 | All             | Vent Window Handle       | 14.95 Ea.  |
| 220    | 58-70 | All             | Handle Plastic Washer    | 1.50 Ea.   |
| 15181  | 59-60 | All             | Vent Window Regulator LH | 179.95 Ea. |
| 15182  | 59-60 | All             | Vent Window Regulator RH | 179.95 Ea. |
| 15183  | 61-64 | All             | Vent Window Regulator LH | 99.95 Ea.  |
| 15184  | 61-64 | All             | Vent Window Regulator RH | 99.95 Ea.  |
| 15795  | 65    | All             | Vent Window Regulator LH | 89.95 Ea.  |
| 15796  | 65    | All             | Vent Window Regulator RH | 89.95 Ea.  |

### WINDOW ROLLERS



12839

12840

12841

| Part # | Year  | Model | Part  | Price     |
|--------|-------|-------|---|-----------|
| 684    | 58-64 | All   | Rear Quarter Window Grooved Roller For Regulators w/ 5/16" Hole | 3.00 Ea.  |
| 12839  | 58-65 | All   | Door Window Non-Grooved Roller For Regulators w/ 1/4" Hole      | 7.95 Ea.  |
| 12840  | 66-68 | All   | Lower 1/4 Window Roller   | 7.95 Ea.  |
| 12841  | 67-68 | All   | Door Window Roller Assembly LH                                  | 17.95 Ea. |
| 12842  | 67-68 | All   | Door Window Roller Assembly RH                                  | 17.95 Ea. |
| 15497  | 69-70 | All   | Door Window Roller  | 11.95 Ea. |

### QUARTER WINDOW PIVOT ASSEMBLIES

| Part # | Year  | Model       | Part                            | Price       |
|--------|-------|-------------|---------------------------------|-------------|
| 16234  | 59-60 | Convertible | Quarter Window Pivot Assemblies | 205.95 Pair |

### QUARTER WINDOW TRACK RELINE KIT

| Part # | Year  | Model       | Part                        | Price     |
|--------|-------|-------------|-----------------------------|-----------|
| 16003  | 58-64 | Convertible | 1/4 Window Track Reline Kit | 45.95 Kit |

# Window Parts

## WINDOW HANDLES



| Part # | Year  | Model             | Part                     | Price     |
|--------|-------|-------------------|--------------------------|-----------|
| 12937  | 58    | Impala            | Window Handle            | 22.95 Ea. |
| 12861  | 59-60 | Impala            | Window Handle            | 12.95 Ea. |
| 13147  | 61-64 | Impala/ Impala SS | Window Handle            | 12.95 Ea. |
| 12059  | 65-66 | Impala            | Window Handle            | 14.95 Ea. |
| 12058  | 58-60 | Biscayne/ Belair  | Window Handle            | 11.95 Ea. |
| 12058  | 61-64 | Biscayne          | Window Handle            | 11.95 Ea. |
| 13149  | 65-66 | Biscayne          | Window Handle            | 22.95 Ea. |
| 12060  | 67-70 | All               | Window Handle Clear Knob | 6.95 Ea.  |
| 5446   | 67-70 | All               | Window Handle Black Knob | 6.95 Ea.  |
| 12936  | 58    | Impala            | Vent Window Handle       | 22.95 Ea. |
| 12862  | 59-60 | Impala            | Vent Window Handle       | 12.95 Ea. |
| 13148  | 61-64 | Impala/ Impala SS | Vent Window Handle       | 12.95 Ea. |
| 12063  | 65-66 | Impala/ Impala SS | Vent Window Handle       | 14.95 Ea. |
| 12062  | 58-60 | Biscayne/ Belair  | Vent Window Handle       | 11.95 Ea. |
| 12062  | 61-64 | Biscayne          | Vent Window Handle       | 11.95 Ea. |
| 13150  | 65-66 | Biscayne          | Vent Window Handle       | 12.95 Ea. |
| 220    | 58-70 | All               | Handle Plastic Washer    | 1.50 Ea.  |
| 12938  | 58    | Impala            | Handle Escutcheon Bezel  | 13.95 Ea. |

## WINDOW DIVISION BAR CHANNELS



| Part # | Year  | Model                     | Part                  | Price      |
|--------|-------|---------------------------|-----------------------|------------|
| 12165  | 58-62 | 2-Dr Hardtop/ Convertible | Division Bar Channels | 28.95 Pair |
| 1885   | 58-62 | Sedan                     | Division Bar Channels | 25.95 Pair |
| 1885   | 59-60 | El Camino                 | Division Bar Channels | 25.95 Pair |
| 12165  | 63-64 | All                       | Division Bar Channels | 28.95 Pair |
| 15583  | 65-68 | All                       | Division Bar Liner    | 43.95 Pair |

## VENT WINDOW ASSEMBLY STOPS



| Part # | Year  | Model                       | Part                  | Price      |
|--------|-------|-----------------------------|-----------------------|------------|
| 12087  | 58    | Hardtop/ Convertible/ Nomad | Vent Assemblies Stops | 19.95 Pair |
| 12088  | 59-60 | 2-Door Hardtop              | Vent Assemblies Stops | 38.95 Pair |
| 12089  | 61-62 | 2-Door Hardtop              | Vent Assemblies Stops | 38.95 Pair |
| 15536  | 61-62 | Convertible                 | Vent Assemblies Stops | 25.95 Pair |
| 12090  | 63-64 | Hardtop                     | Vent Assemblies Stops | 25.95 Pair |
| 12091  | 63-64 | Convertible                 | Vent Assemblies Stops | 29.95 Pair |

## QUARTER WINDOW STOPS



| Part # | Year  | Model                | Part                                     | Price      |
|--------|-------|----------------------|--|------------|
| 12064  | 58    | 2-Door Hardtop       | Quarter Window Stops                     | 44.95 Pair |
| 12065  | 58    | Convertible          | Quarter Window Stops                     | 22.95 Pair |
| 1871   | 58    | Hardtop/Con-vertible | Quarter Window Frame Stops               | 7.95 Pair  |
| 12066  | 59-60 | 2-Door Hardtop       | Quarter Window Stops                     | 28.95 Pair |
| 12067  | 59-60 | Convertible          | Quarter Window Stops                     | 45.95 Pair |
| 12068  | 61-64 | 2-Door Hardtop       | Quarter Window Stops                     | 22.95 Pair |
| 12069  | 61-64 | Convertible          | Quarter Window Stops                     | 22.95 Pair |
| 12070  | 65-66 | 2-Door Hardtop       | Quarter Window Stops                     | 30.95 Pair |
| 12071  | 67-68 | 2-Door Hardtop       | Quarter Window Stops                     | 89.95 Pair |
| 12072  | 69-70 | 2-Door Hardtop       | Quarter Window Stops                     | 89.95 Pair |
| 16007  | 61-64 | Hardtop/Con-vertible | Lower Window Frame Stops (Does One Side) | 22.95 Set  |

## QUARTER WINDOW VERTICAL MOLDING



| Part # | Year  | Model                | Part                        | Price      |
|--------|-------|----------------------|-----------------------------|------------|
| 16004  | 65-66 | Hardtop/ Convertible | 1/4 Window Vertical Molding | 82.95 Pair |
| 16005  | 67-68 | Hardtop/ Convertible | 1/4 Window Vertical Molding | 82.95 Pair |
| 16006  | 69-70 | Hardtop/ Convertible | 1/4 Window Vertical Molding | 82.95 Pair |

# Window Parts

## WINDOW STOPS



| Part # | Year  | Model                   | Part                       | Price      |
|--------|-------|-------------------------|----------------------------|------------|
| 688    | 58    | 2-Door Hardtop          | Window Bottom Stops        | 8.95 Set   |
| 12083  | 58    | Sedan                   | Window Bottom Stop         | 3.00 Ea.   |
| 12084  | 59-60 | Sedan                   | Window Bottom Stop         | 2.50 Ea.   |
| 12085  | 58    | 2-Door Hardtop          | Window Stop Complete       | 25.95 Kit  |
| 330    | 58    | All                     | Window Stops Only          | 9.95 Set   |
| 12086  | 70    | 2-Door                  | Window Stops Only          | 3.00 Set   |
| 687    | 58-64 | All                     | Glass Roller Rubbers       | 3.00 Set   |
| 12064  | 58    | 2-Door Hardtop          | Quarter Window Stops       | 44.95 Pair |
| 12065  | 58    | Convertible             | Quarter Window Stops       | 22.95 Pair |
| 1871   | 58    | Hardtop/<br>Convertible | Quarter Win Frame<br>Stops | 7.95 Pair  |
| 12066  | 59-60 | 2-Door Hardtop          | Quarter Window Stops       | 28.95 Pair |
| 12067  | 59-60 | Convertible             | Quarter Window Stops       | 45.95 Pair |
| 12068  | 61-64 | 2-Door Hardtop          | Quarter Window Stops       | 19.95 Pair |
| 12069  | 61-64 | Convertible             | Quarter Window Stops       | 19.95 Pair |
| 12070  | 65-66 | 2-Door Hardtop          | Quarter Window Stops       | 30.95 Pair |
| 12071  | 67-68 | 2-Door Hardtop          | Quarter Window Stops       | 89.95 Pair |
| 12072  | 69-70 | 2-Door Hardtop          | Quarter Window Stops       | 89.95 Pair |

## WINDOW BELT MOLDINGS



| Part # | Year  | Model                   | Part                         | Price       |
|--------|-------|-------------------------|------------------------------|-------------|
| 15825  | 63-64 | Hardtop/<br>Convertible | Vent Window Belt<br>Moldings | 89.95 Pair  |
| 15826  | 62-64 | Hardtop/<br>Convertible | Door Belt Moldings           | 129.95 Pair |
| 15827  | 62-64 | Hardtop                 | Quarter Belt Moldings        | 95.95 Pair  |

## WINDOW CHANNEL KITS



| Part #  | Year | Model                  | Part               | Price      |
|---------|------|------------------------|--------------------|------------|
| 12152 ① | 65   | Impala 2-Dr<br>Hardtop | Window Channel Kit | 159.95 Kit |
| 12159 ① | 65   | Impala 4-Dr<br>Hardtop | Window Channel Kit | 169.95 Kit |

### For Cars Built Before January Of 1965.

|         |       |                         |                    |            |
|---------|-------|-------------------------|--------------------|------------|
| 12153 ① | 66    | Impala 2-Dr<br>Hardtop  | Window Channel Kit | 179.95 Kit |
| 12160 ① | 66    | Impala 4-Dr<br>Hardtop  | Window Channel Kit | 169.95 Kit |
| 12154 ① | 67-68 | Impala 2-Dr<br>Hardtop  | Window Channel Kit | 189.95 Kit |
| 12161 ① | 67-68 | Impala 4-Dr<br>Hardtop  | Window Channel Kit | 169.95 Kit |
| 12158 ① | 68    | Impala Coupe            | Window Channel Kit | 169.95 Kit |
| 12155 ① | 65    | Impala<br>Convertible   | Window Channel Kit | 155.95 Kit |
| 12156 ① | 66    | Impala<br>Convertible   | Window Channel Kit | 179.95 Kit |
| 15276 ① | 67    | Impala 4-Dr<br>Sedan    | Window Channel Kit | 209.95 Kit |
| 12157 ① | 67-68 | Impala<br>Convertible   | Window Channel Kit | 169.95 Kit |
| 12162 ① | 66    | Caprice 2-Dr<br>Hardtop | Window Channel Kit | 179.95 Kit |
| 12163 ① | 67    | Caprice 2-Dr<br>Hardtop | Window Channel Kit | 169.95 Kit |
| 12164 ① | 68    | Caprice 2-Dr<br>Hardtop | Window Channel Kit | 169.95 Kit |

## UPPER WINDOW CHANNELS



| Part #  | Year  | Model       | Part  | Price      |
|---------|-------|-------------|---|------------|
| 13080 ① | 58    | 2-Dr Sedan  | Upper Window Channel                        | 129.95 Set |
| 13081 ① | 59-60 | 2-Dr Sedan  | Upper Window Channel                        | 149.95 Set |
| 15645 ① | 59-60 | 2-Dr Wagon  | Upper Window Channel                        | 159.95 Set |
| 12733 ① | 61-62 | 2-Dr Sedan  | Upper Window Channel                        | 149.95 Set |
| 12734 ① | 63-64 | 2-Dr Sedan  | Upper Window Channel                        | 149.95 Set |
| 12735 ① | 61-64 | 4-Dr Sedan  | Upper Window Channel                        | 149.95 Set |
| 15275 ① | 61-64 | 4-Dr Wagon  | Upper Window Channel                        | 159.95 Set |
| 16013 ① | 65-66 | 2-Dr Sedan  | Upper Window Channel                        | 118.95 Set |
| 16012 ① | 65-66 | 4-Dr Sedan  | Upper Window Channel                        | 129.95 Set |
| 13079 ① | 59-60 | El Camino   | Upper Window Channel                        | 69.95 Pair |
| 15676   | 58-64 | Convertible | Lower Quarter Window<br>Channel Felting Kit | 18.95 Kit  |

① = add \$8.95 handling per item

## Window Parts / Window Seals

### QUARTER WINDOW VERTICAL SEAL RETAINERS



**13007**

| Part # | Year  | Model                   | Part                    | Price     |
|--------|-------|-------------------------|-------------------------|-----------|
| 13007  | 58    | Hardtop/<br>Convertible | Vertical Seal Retainers | 25.95 Ea. |
| 13008  | 59-60 | Hardtop/<br>Convertible | Vertical Seal Retainers | 25.95 Ea. |

### SIDE WINDOW SEAL

| Part # | Year  | Model      | Part              | Price       |
|--------|-------|------------|-------------------|-------------|
| 16033  | 59-60 | 4-Dr Wagon | Side Window Seals | 109.95 Pair |
| 16032  | 63-64 | 4-Dr Wagon | Side Window Seals | 139.95 Pair |

### BACK GLASS SEALS



**12194**

| Part # | Year  | Model               | Part            | Price     |
|--------|-------|---------------------|-----------------|-----------|
| 12187  | 58    | All                 | Back Glass Seal | 55.95 Ea. |
| 12188  | 59-60 | Impala 2-Dr Hardtop | Back Glass Seal | 39.95 Ea. |
| 15505  | 61    | Sedan               | Back Glass Seal | 49.95 Ea. |
| 12189  | 61    | Impala 2-Dr Hardtop | Back Glass Seal | 45.95 Ea. |
| 12189  | 61-62 | Bubble Top          | Back Glass Seal | 45.95 Ea. |
| 12190  | 62-64 | Impala 2-Dr Hardtop | Back Glass Seal | 35.95 Ea. |
| 12191  | 63-64 | Impala 4-Dr Hardtop | Back Glass Seal | 30.95 Ea. |
| 12192  | 59-60 | Sedan               | Back Glass Seal | 89.95 Ea. |
| 12193  | 62-64 | Sedan               | Back Glass Seal | 69.95 Ea. |
| 12194  | 58    | Wagon/Sedan Delv    | Back Glass Seal | 49.95 Ea. |
| 12195  | 59-60 | Sedan Delivery      | Back Glass Seal | 35.95 Ea. |
| 12196  | 59-60 | El Camino           | Back Glass Seal | 59.95 Ea. |

### WINDOW DRAIN SEALS



**819**

**12074**

**12082**

| Part # | Year  | Model                   | Part                   | Price      |
|--------|-------|-------------------------|------------------------|------------|
| 819    | 58-60 | Hardtop/<br>Convertible | Windshield Drain Tubes | 14.95 Pair |
| 12074  | 61-62 | All                     | Windshield Drain Tubes | 69.95 Pair |
| 12081  | 58-60 | Sedan                   | Rear Glass Drain Tubes | 16.95 Pair |
| 12082  | 61-63 | Convertible             | Rear Drain Tubes       | 25.95 Pair |

### QUARTER WINDOW VERTICAL SEALS



**12092**

**12097**

**12098**

| Part # | Year  | Model                        | Part                      | Price      |
|--------|-------|------------------------------|---------------------------|------------|
| 12092  | 58    | 2-Dr Hardtop                 | 1/4 Window Vertical Seals | 25.95 Pair |
| 12093  | 58    | Convertible                  | 1/4 Window Vertical Seals | 25.95 Pair |
| 12094  | 59-60 | 2-Dr Hardtop                 | 1/4 Window Vertical Seals | 9.95 Pair  |
| 12095  | 59-60 | Convertible                  | 1/4 Window Vertical Seals | 20.95 Pair |
| 12096  | 61    | 2-Dr Hardtop                 | 1/4 Window Vertical Seals | 20.95 Pair |
| 12097  | 62-64 | 2-Dr Hardtop/<br>Convertible | 1/4 Window Vertical Seals | 20.95 Pair |
| 12096  | 62    | Bubble Top                   | 1/4 Window Vertical Seals | 20.95 Pair |
| 12098  | 65-66 | Hardtop/<br>Convertible      | 1/4 Window Vertical Seals | 20.95 Pair |
| 12099  | 67-68 | 2-Dr Hardtop                 | 1/4 Window Vertical Seals | 20.95 Pair |
| 15216  | 69-70 | Hardtop                      | 1/4 Window Vertical Seals | 15.95 Pair |

### WINDSHIELD PILLAR POST SEALS



**390**

**12166**

**12167**

**12168**

**12169**

**12170**

**12171**

**12172**

| Part # | Year  | Model                   | Part                         | Price      |
|--------|-------|-------------------------|------------------------------|------------|
| 390    | 58    | Hardtop/<br>Convertible | Windshield Pillar Post Seals | 7.95 Pair  |
| 12166  | 59-60 | Convertible             | Windshield Pillar Post Seals | 49.95 Pair |
| 12167  | 61    | Convertible             | Windshield Pillar Post Seals | 49.95 Pair |
| 12168  | 62    | Convertible             | Windshield Pillar Post Seals | 45.95 Pair |
| 12169  | 63-64 | Convertible             | Windshield Pillar Post Seals | 45.95 Pair |
| 12170  | 65    | Convertible             | Windshield Pillar Post Seals | 65.95 Pair |
| 12171  | 66-68 | Convertible             | Windshield Pillar Post Seals | 69.95 Pair |
| 12172  | 69-70 | Convertible             | Windshield Pillar Post Seals | 69.95 Pair |

# Window Seals

## WINDSHIELD SEALS



12174



12176

| Part # | Year  | Model                        | Part            | Price     |
|--------|-------|------------------------------|-----------------|-----------|
| 12173  | 58    | Impala 2-Dr Hardtop          | Windshield Seal | 35.95 Ea. |
| 12174  | 59-60 | Impala 2-Dr Hardtop          | Windshield Seal | 35.95 Ea. |
| 12175  | 61    | Impala 2-Dr Hardtop          | Windshield Seal | 35.95 Ea. |
| 12177  | 62    | Impala 2-Dr Hardtop          | Windshield Seal | 35.95 Ea. |
| 12185  | 61-62 | Impala 4-Dr Hardtop          | Windshield Seal | 35.95 Ea. |
| 12176  | 61-62 | Belair 2-Dr Hardtop          | Windshield Seal | 59.95 Ea. |
| 12181  | 61    | Belair 4-Dr Hardtop          | Windshield Seal | 35.95 Ea. |
| 12178  | 63-64 | Impala 2-Dr Hardtop          | Windshield Seal | 35.95 Ea. |
| 12182  | 63-64 | Impala 4-Dr Hardtop          | Windshield Seal | 35.95 Ea. |
| 13159  | 58    | Impala Convertible           | Windshield Seal | 49.95 Ea. |
| 12174  | 59-60 | Impala Convertible           | Windshield Seal | 35.95 Ea. |
| 12179  | 61-62 | Impala Convertible           | Windshield Seal | 35.95 Ea. |
| 12180  | 63-64 | Impala Convertible           | Windshield Seal | 35.95 Ea. |
| 12183  | 58    | Biscayne/ Del/Belair         | Windshield Seal | 35.95 Ea. |
| 12184  | 59-60 | Impala Sedan                 | Windshield Seal | 35.95 Ea. |
| 12185  | 61-62 | Impala 4-Dr Sedan            | Windshield Seal | 35.95 Ea. |
| 12185  | 61-62 | Biscayne/ Belair Sedan       | Windshield Seal | 35.95 Ea. |
| 12186  | 63-64 | Impala 4-Dr Sedan            | Windshield Seal | 35.95 Ea. |
| 12186  | 63-64 | Biscayne/ Belair Sedan       | Windshield Seal | 35.95 Ea. |
| 12185  | 61-62 | Biscayne/Belair Wagon        | Windshield Seal | 35.95 Ea. |
| 12186  | 63-64 | Impala Wagon                 | Windshield Seal | 35.95 Ea. |
| 12186  | 63-64 | Biscayne/Belair Wagon        | Windshield Seal | 35.95 Ea. |
| 12185  | 61-62 | Brookwood/<br>Parkwood Wagon | Windshield Seal | 35.95 Ea. |
| 12184  | 59-60 | El Camino                    | Windshield Seal | 35.95 Ea. |

## STATIONARY QUARTER WINDOW SEALS



| Part # | Year  | Model      | Part                           | Price       |
|--------|-------|------------|--------------------------------|-------------|
| 16031  | 59-60 | 4-Dr Sedan | Stationary Quarter Window Seal | 149.95 Pair |



Repops has been a manufacturer of reproduction parts since 1991. Like many other companies in this industry it was started in a garage as a hobby and then grew from there. In the late 90's the company started the first line of "authentic" beltline kits, revolutionizing that product line. Since that time we have continued to be the leaders in beltline kits in both quality and quantity of types of kits offered. Also expanding into 12 other classes of parts such as heater seal kits and glovebox liners etc. Repops calling card has been their commitment to the end customers. Offering a rare Lifetime Warranty to the original purchaser of the product, plus the included customer service number for questions regarding purchased parts. All of this adds up to confidence for our dealers when selling a Repops part.

## 58-60 WINDOW FELT KITS



| Part # | Year  | Model                      | Part           | Price      |
|--------|-------|----------------------------|----------------|------------|
| 12102  | 58    | Belair 2-Dr Hardtop        | Window Feltkit | 109.95 Kit |
| 12133  | 58    | Belair 4-Dr Hardtop        | Window Feltkit | 115.95 Kit |
| 12103  | 58    | Impala 2-Dr Hardtop        | Window Feltkit | 119.95 Kit |
| 12150  | 58    | Brookwood 4-Dr Wagon       | Window Feltkit | 119.95 Kit |
| 12118  | 58    | Impala Convertible         | Window Feltkit | 119.95 Kit |
| 12126  | 58    | Biscayne 2-Dr Sedan        | Window Feltkit | 119.95 Kit |
| 12143  | 58    | Biscayne/Delray 4-Dr Sedan | Window Feltkit | 109.95 Kit |
| 12127  | 58    | Belair 2-Dr Sedan          | Window Feltkit | 119.95 Kit |
| 12144  | 58    | Belair 4-Dr Sedan          | Window Feltkit | 119.95 Kit |
| 12134  | 59-60 | Belair 4-Dr Hardtop        | Window Feltkit | 119.95 Kit |
| 12104  | 59-60 | Impala 2-Dr Hardtop        | Window Feltkit | 119.95 Kit |
| 12135  | 59-60 | Impala 4-Dr Hardtop        | Window Feltkit | 117.95 Kit |
| 12119  | 59-60 | Impala Convertible         | Window Feltkit | 119.95 Kit |
| 12128  | 59-60 | Belair 2-Dr Sedan          | Window Feltkit | 119.95 Kit |
| 12145  | 59-60 | Belair 4-Dr Sedan          | Window Feltkit | 119.95 Kit |
| 12146  | 59-60 | Impala 4-Dr Sedan          | Window Feltkit | 119.95 Kit |
| 12151  | 59-60 | El Camino                  | Window Feltkit | 55.95 Kit  |
| 15274  | 60    | Belair 2-Dr Hardtop        | Window Feltkit | 89.95 Kit  |

# Window Felt Kits

## 61-62 WINDOW FELT KITS

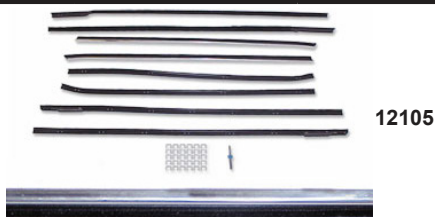

| Part #  | Year  | Model                      | Part                 | Price      |
|---------|-------|----------------------------|----------------------|------------|
| 12105 ① | 61    | Impala 2-Dr Hardtop        | Window Feltkit       | 119.95 Kit |
| 12137 ① | 61-62 | Impala 4-Dr Hardtop        | Window Feltkit       | 125.95 Kit |
| 12130 ① | 61-62 | Impala 2-Dr Sedan          | Window Feltkit       | 119.95 Kit |
| 12129 ① | 61-62 | Biscayne/Belair 2-Dr Sedan | Window Feltkit       | 119.95 Kit |
| 12147 ① | 61-62 | Belair 4-Dr Sedan          | Window Feltkit       | 119.95 Kit |
| 12148 ① | 61-62 | Impala 4-Dr Sedan          | Window Feltkit       | 119.95 Kit |
| 15709   | 61-62 | Biscayne/Belair Wagon      | Tailgate Window Felt | 79.95 Kit  |
| 12107 ① | 61-62 | Belair 2-Dr Hardtop        | Window Feltkit       | 129.95 Kit |
| 12136 ① | 61-62 | Belair 4-Dr Hardtop        | Window Feltkit       | 119.95 Kit |
| 12120 ① | 61-62 | Impala Convertible         | Window Feltkit       | 119.95 Kit |
| 12106 ① | 62    | Impala 2-Dr Hardtop        | Window Feltkit       | 119.95 Kit |

## 63-64 WINDOW FELT KITS



| Part #  | Year  | Model                      | Part                 | Price      |
|---------|-------|----------------------------|----------------------|------------|
| 12108 ① | 63-64 | Impala 2-Dr Hardtop        | Window Feltkit       | 119.95 Kit |
| 12138 ① | 63-64 | Impala 4-Dr Hardtop        | Window Feltkit       | 125.95 Kit |
| 12149 ① | 63-64 | Impala 4-Dr Wagon          | Window Feltkit       | 119.95 Kit |
| 12129 ① | 63-64 | Biscayne/Belair 2-Dr Sedan | Window Feltkit       | 119.95 Kit |
| 12147 ① | 63-64 | Belair 4-Dr Sedan          | Window Feltkit       | 119.95 Kit |
| 12148 ① | 63-64 | Impala 4-Dr Sedan          | Window Feltkit       | 119.95 Kit |
| 15709   | 63-64 | Biscayne/Belair Wagon      | Tailgate Window Felt | 79.95 Kit  |
| 12121 ① | 63-64 | Impala Convertible         | Window Feltkit       | 119.95 Kit |

## 65-66 WINDOW FELT KITS



| Part #  | Year  | Model   | Part                 | Price      |
|---------|-------|---|----------------------|------------|
| 12131 ① | 65    | Impala 2-Dr Sedan                                 | Window Feltkit       | 125.95 Kit |
| 12122 ① | 65    | Impala Convertible                                | Window Feltkit       | 139.95 Kit |
| 12109 ① | 65    | Impala 2-Dr Hardtop                               | Window Feltkit       | 149.95 Kit |
| 12139 ① | 65    | Impala 4-Dr Hardtop w/o Special Belt Line Molding | Window Feltkit       | 139.95 Kit |
| 15708   | 65    | 4-Dr Hardtop w/Special Belt Line Molding          | Window Feltkit       | 139.95 Kit |
| 15445 ① | 65-66 | Belair 2-Dr Sedan                                 | Window Feltkit       | 119.95 Kit |
| 15647   | 65-66 | Impala 4-Dr Wagon                                 | Tailgate Window Felt | 49.95 Kit  |
| 12123 ① | 66    | Impala Convertible                                | Window Feltkit       | 149.95 Kit |
| 12110 ① | 66    | Impala 2-Dr Hardtop                               | Window Feltkit       | 149.95 Kit |
| 12139 ① | 66    | Impala 4-Dr Hardtop                               | Window Feltkit       | 139.95 Kit |
| 12111 ① | 66    | Caprice 2-Dr Hardtop                              | Window Feltkit       | 139.95 Kit |

## 67-68 WINDOW FELT KITS



| Part #  | Year  | Model                      | Part           | Price      |
|---------|-------|----------------------------|----------------|------------|
| 15646   | 67    | Impala 4-Dr Sedan          | Window Feltkit | 139.95 Kit |
| 12113 ① | 67    | Caprice 2-Dr Hardtop       | Window Feltkit | 139.95 Kit |
| 12141 ① | 67    | Caprice 4-Dr Hardtop       | Window Feltkit | 129.95 Kit |
| 12112 ① | 67-68 | Impala 2-Dr Hardtop        | Window Feltkit | 149.95 Kit |
| 12124 ① | 67-68 | Impala Convertible         | Window Feltkit | 149.95 Kit |
| 12140 ① | 67-68 | Impala 4-Dr Hardtop        | Window Feltkit | 149.95 Kit |
| 12132 ① | 67-68 | Biscayne/Belair 2-Dr Sedan | Window Feltkit | 125.95 Kit |
| 12114 ① | 68    | Impala Custom Coupe        | Window Feltkit | 149.95 Kit |
| 12115 ① | 68    | Caprice Custom Coupe       | Window Feltkit | 149.95 Kit |
| 15277 ① | 68    | Impala Wagon               | Window Feltkit | 89.95 Kit  |
| 12164 ① | 68    | Caprice 2-Dr Hardtop       | Window Feltkit | 169.95 Kit |

## 69-70 WINDOW FELT KITS



| Part #  | Year  | Model                | Part           | Price      |
|---------|-------|----------------------|----------------|------------|
| 12116 ① | 69-70 | Impala 2-Dr Hardtop  | Window Feltkit | 149.95 Kit |
| 12142 ① | 69-70 | Impala 4-Dr Hardtop  | Window Feltkit | 155.95 Kit |
| 12117 ① | 69-70 | Caprice 2-Dr Hardtop | Window Feltkit | 149.95 Kit |
| 12125 ① | 69-70 | Impala Convertible   | Window Feltkit | 149.95 Kit |
| 16014   | 69-70 | Impala 4-Dr Sedan    | Window Feltkit | 139.95 Kit |

① = add \$8.95 handling per item

# Weatherstrips

## WEATHERSTRIP KITS INFO



Our weatherstrip kits are assembled from our inventory. We have chosen to assemble them our selves, so we can provide you the customer with the best products on the market.

### CONTENTS LEGEND

|                       |                          |
|-----------------------|--------------------------|
| A = Door Rubber       | F = Pillar Post Seal     |
| B = Door J-Seal       | G = Vertical Window Seal |
| C = Trunk Rubber      | H = Vent Window Rubber   |
| D = Windshield Rubber | I = Window Felt Kit      |
| E = Back Glass Rubber | J = Roof Rail Seals      |

### BASIC WEATHERSTRIP KITS



12459



13217



12476

| Part # | Year  | Model                    | Part      | Price      | Contents |
|--------|-------|--------------------------|-----------|------------|----------|
| 12459  | 58    | 2-Dr Hardtop/Convertible | Basic Kit | 101.95 Kit | A,B,C    |
| 12460  | 59-60 | 2-Dr Hardtop/Convertible | Basic Kit | 102.95 Kit | A,B,C    |
| 12461  | 61-62 | 2-Dr Hardtop/Convertible | Basic Kit | 82.95 Kit  | A,C      |
| 12462  | 63-64 | 2-Dr Hardtop/Convertible | Basic Kit | 82.95 Kit  | A,C      |
| 12463  | 65-66 | 2-Dr Hardtop/Convertible | Basic Kit | 82.95 Kit  | A,C      |
| 12464  | 67-68 | 2-Dr Hardtop/Convertible | Basic Kit | 82.95 Kit  | A,C      |
| 12465  | 69-70 | 2-Dr Hardtop/Convertible | Basic Kit | 82.95 Kit  | A,C      |
| 12548  | 59-60 | 4-Dr Hardtop             | Basic Kit | 309.95 Kit | A,B,C    |
| 12549  | 61-62 | 4-Dr Hardtop             | Basic Kit | 298.95 Kit | A,C      |
| 13216  | 63-64 | 4-Dr Hardtop             | Basic Kit | 290.95 Kit | A,C      |
| 13217  | 65-66 | 4-Dr Hardtop             | Basic Kit | 171.95 Kit | A,C      |
| 13218  | 67-68 | 4-Dr Hardtop             | Basic Kit | 171.95 Kit | A,C      |
| 12466  | 58    | 2-Dr Sedan               | Basic Kit | 94.95 Kit  | A,B,C    |
| 12467  | 59-60 | 2-Dr Sedan               | Basic Kit | 94.95 Kit  | A,B,C    |
| 12468  | 61-64 | 2-Dr Sedan               | Basic Kit | 78.95 Kit  | A,C      |
| 12469  | 65-66 | 2-Dr Sedan               | Basic Kit | 78.95 Kit  | A,C      |
| 12470  | 67-68 | 2-Dr Sedan               | Basic Kit | 78.95 Kit  | A,C      |
| 12471  | 58    | 4-Dr Sedan               | Basic Kit | 149.95 Kit | A,B,C    |
| 12472  | 59-60 | 4-Dr Sedan               | Basic Kit | 150.95 Kit | A,B,C    |
| 12473  | 61-62 | 4-Dr Sedan               | Basic Kit | 162.95 Kit | A,C      |
| 12474  | 63-64 | 4-Dr Sedan               | Basic Kit | 162.95 Kit | A,C      |
| 12475  | 65-66 | 4-Dr Sedan               | Basic Kit | 137.95 Kit | A,C      |
| 12476  | 67-68 | 4-Dr Sedan               | Basic Kit | 137.95 Kit | A,C      |
| 12477  | 59-60 | El Camino                | Basic Kit | 78.95 Kit  | A,B      |

# Windows

## CONTENTS LEGEND

|                       |                          |
|-----------------------|--------------------------|
| A = Door Rubber       | F = Pillar Post Seal     |
| B = Door J-Seal       | G = Vertical Window Seal |
| C = Trunk Rubber      | H = Vent Window Rubber   |
| D = Windshield Rubber | I = Window Felt Kit      |
| E = Back Glass Rubber | J = Roof Rail Seals      |

## DELUXE WEATHERSTRIP KITS



12478



13219



12502

| Part # | Year  | Model                  | Part                    | Price      | Contents            |
|--------|-------|------------------------|-------------------------|------------|---------------------|
| 12478  | 58    | Impala 2-Door Hardtop  | Deluxe Weatherstrip Kit | 444.95 Kit | A,B,C,D,E,F,G,H,I,J |
| 12479  | 58    | Bel 2-Door Hardtop     | Deluxe Weatherstrip Kit | 537.95 Kit | A,B,C,D,E,F,H,I,J   |
| 12480  | 59-60 | Impala 2-Door Hardtop  | Deluxe Weatherstrip Kit | 411.95 Kit | A,B,C,D,E,G,H,I,J   |
| 16227  | 61    | Impala 2-Door Hardtop  | Deluxe Weatherstrip Kit | 435.95 Kit | A,C,D,E,G,H,I,J     |
| 12481  | 61    | Impala 2-Door Hardtop  | Deluxe Weatherstrip Kit | 435.95 Kit | A,C,D,E,G,H,I,J     |
| 12482  | 62    | Impala 2-Door Hardtop  | Deluxe Weatherstrip Kit | 398.95 Kit | A,C,D,E,G,H,I,J     |
| 12483  | 63-64 | Impala 2-Door Hardtop  | Deluxe Weatherstrip Kit | 393.95 Kit | A,C,D,E,G,H,I,J     |
| 12484  | 65    | Impala 2-Door Hardtop  | Deluxe Weatherstrip Kit | 343.95 Kit | A,C,G,H,I,J         |
| 12485  | 66    | Impala 2-Door Hardtop  | Deluxe Weatherstrip Kit | 360.95 Kit | A,C,G,H,I,J         |
| 12486  | 66    | Caprice 2-Door Hardtop | Deluxe Weatherstrip Kit | 310.95 Kit | A,C,G,I,J           |
| 12487  | 67-68 | Impala 2-Door Hardtop  | Deluxe Weatherstrip Kit | 324.95 Kit | A,C,G,H,I,J         |
| 12488  | 67    | Caprice 2-Door Hardtop | Deluxe Weatherstrip Kit | 307.95 Kit | A,C,G,I,J           |
| 12489  | 68    | Caprice 2-Door Hardtop | Deluxe Weatherstrip Kit | 307.95 Kit | A,C,G,I,J           |
| 12490  | 69-70 | Impala 2-Door Hardtop  | Deluxe Weatherstrip Kit | 209.95 Kit | A,C,I               |
| 13219  | 59-60 | Bel 4-Door Hardtop     | Deluxe Weatherstrip Kit | 509.95 Kit | A,B,C,I,J           |
| 13220  | 59-60 | Impala 4-Door Hardtop  | Deluxe Weatherstrip Kit | 517.95 Kit | A,B,C,I,J           |
| 13221  | 61-62 | Bel 4-Door Hardtop     | Deluxe Weatherstrip Kit | 536.95 Kit | A,C,D,I,J           |
| 13222  | 61-62 | Impala 4-Door Hardtop  | Deluxe Weatherstrip Kit | 541.95 Kit | A,C,D,I,J           |
| 13223  | 63-64 | Impala 4-Door Hardtop  | Deluxe Weatherstrip Kit | 519.95 Kit | A,C,D,E,I,J         |
| 13224  | 65    | Impala 4-Door Hardtop  | Deluxe Weatherstrip Kit | 382.95 Kit | A,C,I,J             |
| 13225  | 66    | Impala 4-Door Hardtop  | Deluxe Weatherstrip Kit | 382.95 Kit | A,C,I,J             |
| 13226  | 67-68 | Impala 4-Door Hardtop  | Deluxe Weatherstrip Kit | 400.95 Kit | A,C,I               |
| 12491  | 58    | Convertible            | Deluxe Weatherstrip Kit | 389.95 Kit | A,B,C,D,F,G,H,I     |
| 12492  | 59-60 | Convertible            | Deluxe Weatherstrip Kit | 366.95 Kit | A,B,C,D,F,G,H,I     |
| 12493  | 61    | Convertible            | Deluxe Weatherstrip Kit | 329.95 Kit | A,C,D,F,H,I         |
| 12494  | 62    | Convertible            | Deluxe Weatherstrip Kit | 302.95 Kit | A,C,D,F,H,I         |
| 12495  | 63-64 | Convertible            | Deluxe Weatherstrip Kit | 302.95 Kit | A,C,D,F,H,I         |
| 12496  | 65    | Convertible            | Deluxe Weatherstrip Kit | 320.95 Kit | A,C,F,G,H,I         |
| 12497  | 66    | Convertible            | Deluxe Weatherstrip Kit | 343.95 Kit | A,C,F,G,H,I         |
| 12498  | 67-68 | Convertible            | Deluxe Weatherstrip Kit | 335.95 Kit | A,C,F,H,I           |
| 12499  | 69-70 | Convertible            | Deluxe Weatherstrip Kit | 268.95 Kit | A,C,F,I             |
| 12500  | 59-60 | El Camino              | Deluxe Weatherstrip Kit | 285.95 Kit | A,B,D,E,I           |
| 12501  | 58    | Biscayne 2-Door Sedan  | Deluxe Weatherstrip Kit | 546.95 Kit | A,B,C,D,E,H,I       |
| 12502  | 58    | Bel 2-Door Sedan       | Deluxe Weatherstrip Kit | 546.95 Kit | A,B,C,D,E,H,I       |

# Windows

## CONTENTS LEGEND

|                       |                          |
|-----------------------|--------------------------|
| A = Door Rubber       | F = Pillar Post Seal     |
| B = Door J-Seal       | G = Vertical Window Seal |
| C = Trunk Rubber      | H = Vent Window Rubber   |
| D = Windshield Rubber | I = Window Felt Kit      |
| E = Back Glass Rubber | J = Roof Rail Seals      |

## DELUXE WEATHERSTRIP KITS

| Part # | Year  | Model                        | Part                    | Price      | Contents      |
|--------|-------|------------------------------|-------------------------|------------|---------------|
| 12503  | 59    | Bel 2-Door Sedan             | Deluxe Weatherstrip Kit | 453.95 Kit | A,B,C,D,E,H,I |
| 12504  | 62    | Biscayne/Belair 2-Door Sedan | Deluxe Weatherstrip Kit | 547.95 Kit | A,C,D,E,H,I   |
| 12505  | 62    | Impala 2-Door Sedan          | Deluxe Weatherstrip Kit | 576.95 Kit | A,B,C,D,E,H,I |
| 12506  | 63-64 | Biscayne/Belair 2-Door Sedan | Deluxe Weatherstrip Kit | 482.95 Kit | A,B,C,D,E,H,I |
| 12507  | 65-66 | Impala 2-Door Sedan          | Deluxe Weatherstrip Kit | 184.95 Kit | A,C,H,I       |
| 12508  | 67-68 | Biscayne/Belair 2-Door Sedan | Deluxe Weatherstrip Kit | 345.95 Kit | A,C,H,I       |
| 12509  | 58    | Biscayne                     | Deluxe Weatherstrip Kit | 406.95 Kit | A,B, C,H,I    |
| 12510  | 59    | Bel 4-Door Sedan             | Deluxe Weatherstrip Kit | 445.95 Kit | A,B,C,H,I     |
| 12511  | 59    | Impala 4-Door Sedan          | Deluxe Weatherstrip Kit | 445.95 Kit | A,B,C,H,I     |
| 10023  | 60    | Bel 2-Door Sedan             | Deluxe Weatherstrip Kit | 677.95 Kit | A,B,C,D,E,H,I |
| 10024  | 60    | Bel 4-Door Sedan             | Deluxe Weatherstrip Kit | 542.95 Kit | A,B,C,H,I     |
| 10619  | 60    | Impala 4-Door Sedan          | Deluxe Weatherstrip Kit | 542.95 Kit | A,B,C,H,I     |
| 12512  | 62    | Bel 4-Door Sedan             | Deluxe Weatherstrip Kit | 572.95 Kit | A,C,H,I       |
| 12513  | 62    | Impala 4-Door Sedan          | Deluxe Weatherstrip Kit | 572.95 Kit | A,C,H,I       |
| 12514  | 63-64 | Bel 4-Door Sedan             | Deluxe Weatherstrip Kit | 454.95 Kit | A,C,H,I       |
| 12515  | 63-64 | Impala 4-Door Sedan          | Deluxe Weatherstrip Kit | 428.95 Kit | A,C,H,I       |



Looking for top quality dependable power windows for your Classic Cars, Classic Trucks, Muscle Cars, Street Rod or Hot Rods? Nu-Relics manufactures direct bolt in gear driven windows for classic cars. The power window conversion kits are truly make and model specific/ designed for the regulator to work like the original manual regulator with correct bolt patterns and arm lengths. Installation is easy – unbolt the manual regulator. Reverse the process and bolt in the power regulator in the exact same location.

Nu-Relics power window kits for classic cars and hot rods provide some great features such as:

- The kits are available with various switch options. Has chrome switches and Nu-Cranks that allows your original crank handle to operate as a power switch.
- Kits include: regulators, motors, completed wire harness, choice of switches, conduit to protect the wires going thru the door. Each product page includes pictures of all the parts included in the kits.
  - Works with curved glass
- Regulators are constructed of durable components (treated gear plates, 1018 cold rolled steel, Bronze Oilite® thrust bearings at pivot, etc.)
- Lifetime warranty against manufactures defects on the regulators, motors, and switches purchased from Nu-Relics Power Windows, LLC.

## FRONT DOOR CONVERSION KITS ONLY



12516

| Part # | Year  | Model                           | Part                          | Price       |
|--------|-------|---------------------------------|-------------------------------|-------------|
| 12516★ | 58    | 2-Dr Hardtop/ Convertible       | Front Dr Only Convertible Kit | 499.95 Pair |
| 12517★ | 59-60 | 2-Dr Hardtop/ Convertible       | Front Dr Only Convertible Kit | 499.95 Pair |
| 16232★ | 59-60 | 2-Dr Sedan/Wagon                | Front Dr Only Convertible Kit | 499.95 Pair |
| 12521★ | 61    | 2-Dr Hardtop/ Convertible       | Front Dr Only Convertible Kit | 499.95 Pair |
| 12526★ | 63-64 | 2-Dr Hardtop/ Convertible       | Front Dr Only Convertible Kit | 499.95 Pair |
| 15290★ | 65-66 | 2-Dr                            | Front Dr Only Convertible Kit | 499.95 Pair |
| 16181★ | 59-60 | El Camino                       | Power Window Convertible Kit  | 499.95 Pair |
| 16183★ | 59-60 | 4Dr Sedan/Wagon                 | Front Dr Only Convertible Kit | 499.95 Pair |
| 16192★ | 62    | 2Dr Hardtop/ Convertible/ Sedan | Front Dr Only Convertible Kit | 499.95 Pair |
| 16208★ | 67-68 | 2Dr Hardtop/ Convertible/ Sedan | Front Dr Only Convertible Kit | 499.95 Pair |
| 16216★ | 70    | 2Dr Hardtop/ Convertible        | Front Dr Only Convertible Kit | 499.95 Pair |

★ = special order non-stocking item, please allow 4-6 weeks for delivery.

# Windows

## FULL POWER WINDOW CONVERSION KITS



| Part # | Year  | Model                   | Part                              | Price      |
|--------|-------|-------------------------|-----------------------------------|------------|
| 12519★ | 58    | Convertible             | Full Power Window Convertible Kit | 925.95 Kit |
| 12518★ | 59-60 | 2-Dr Hardtop            | Full Power Window Convertible Kit | 925.95 Kit |
| 12524★ | 61    | Convertible             | Full Power Window Convertible Kit | 925.95 Kit |
| 12529★ | 63-64 | Convertible             | Full Power Window Convertible Kit | 925.95 Kit |
| 12520★ | 58    | 2-Dr Hardtop            | Full Power Window Convertible Kit | 925.95 Kit |
| 12522★ | 59-60 | Convertible             | Full Power Window Convertible Kit | 925.95 Kit |
| 12525★ | 61    | 2-Dr Hardtop            | Full Power Window Convertible Kit | 925.95 Kit |
| 12530★ | 63-64 | 2-Dr Hardtop            | Full Power Window Convertible Kit | 925.95 Kit |
| 15291★ | 65-66 | Hardtop                 | Full Power Window Convertible Kit | 925.95 Kit |
| 15292★ | 65-66 | Convertible             | Full Power Window Convertible Kit | 925.95 Kit |
| 16185★ | 59-60 | 4Dr Sedan/Wagon         | Full Power Window Convertible Kit | 925.95 Kit |
| 16193★ | 62    | 2Dr Hardtop             | Full Power Window Convertible Kit | 925.95 Kit |
| 16194★ | 62    | Convertible             | Full Power Window Convertible Kit | 925.95 Kit |
| 16195★ | 62    | 2Dr Sedan               | Full Power Window Convertible Kit | 925.95 Kit |
| 16203★ | 63-64 | 2Dr Sedan               | Full Power Window Convertible Kit | 925.95 Kit |
| 16210★ | 67-68 | 2Dr Hardtop/Convertible | Full Power Window Convertible Kit | 925.95 Kit |
| 16218★ | 70    | 2Dr Hardtop/Convertible | Full Power Window Convertible Kit | 925.95 Kit |

## POWER VENT WINDOW KIT



| Part # | Year  | Model | Part                  | Price      |
|--------|-------|-------|-----------------------|------------|
| 15538★ | 59-60 | All   | Power Vent Window Kit | 385.95 Kit |
| 16482★ | 61-64 | All   | Power Vent Window Kit | 385.95 Kit |

★ = special order non-stocking item, please allow 4-6 weeks for delivery.

Most glass items are special order items and we do not keep them in stock. All windshields and some back glass have to be shipped by truck freight.

## FRONT DOOR CONVERSION KITS ONLY WITH NU-CRANKS SWITCHES



| Part # | Year  | Model                         | Part                          | Price       |
|--------|-------|-------------------------------|-------------------------------|-------------|
| 12523★ | 58    | 2Dr Hardtop/Convertible       | Front Dr Only Convertible Kit | 619.95 Pair |
| 16178★ | 59-60 | 2Dr Hardtop/Convertible       | Front Dr Only Convertible Kit | 619.95 Pair |
| 16184★ | 59-60 | 4Dr Sedan/Wagon               | Front Dr Only Convertible Kit | 619.95 Pair |
| 16233★ | 59-60 | 2Dr Sedan/Wagon               | Front Dr Only Convertible Kit | 619.95 Pair |
| 16187★ | 61    | 2Dr Hardtop/Convertible/Sedan | Front Dr Only Convertible Kit | 619.95 Pair |
| 16196★ | 62    | 2Dr Hardtop/Convertible/Sedan | Front Dr Only Convertible Kit | 600.95 Pair |
| 16200★ | 63-64 | 2Dr Hardtop/Convertible/Sedan | Front Dr Only Convertible Kit | 619.95 Pair |
| 16205★ | 65-66 | 2Dr Hardtop/Convertible/Sedan | Front Dr Only Convertible Kit | 619.95 Pair |
| 16209★ | 67-68 | 2Dr Hardtop                   | Front Dr Only Convertible Kit | 619.95 Pair |
| 16217★ | 70    | 2Dr Hardtop/Convertible       | Front Dr Only Convertible Kit | 619.95 Pair |

## FULL POWER WINDOW CONVERSION KITS WITH NU-CRANKS SWITCHES

| Part # | Year  | Model                   | Part                  | Price       |
|--------|-------|-------------------------|-----------------------|-------------|
| 12527★ | 58    | 2Dr Hardtop             | Full Power Window Kit | 1346.95 Set |
| 12528★ | 58    | Convertible             | Full Power Window Kit | 1346.95 Set |
| 16179★ | 59-60 | 2Dr Hardtop             | Full Power Window Kit | 1346.95 Set |
| 16180★ | 59-60 | Convertible             | Full Power Window Kit | 1346.95 Set |
| 16182★ | 59-60 | El Camino               | Full Power Window Kit | 619.95 Pair |
| 16186★ | 59-60 | 4Dr Sedan/Wagon         | Full Power Window Kit | 1346.95 Set |
| 16188★ | 61    | 2Dr Hardtop             | Full Power Window Kit | 1346.95 Set |
| 16189★ | 61    | Convertible             | Full Power Window Kit | 1346.95 Set |
| 16191★ | 61    | 2Dr Sedan               | Full Power Window Kit | 1346.95 Set |
| 16197★ | 62    | 2Dr Hardtop             | Full Power Window Kit | 1346.95 Set |
| 16198★ | 62    | Convertible             | Full Power Window Kit | 1346.95 Set |
| 16199★ | 62    | 2Dr Sedan               | Full Power Window Kit | 1346.95 Set |
| 16201★ | 63-64 | 2Dr Hardtop             | Full Power Window Kit | 1346.95 Set |
| 16202★ | 63-64 | Convertible             | Full Power Window Kit | 1346.95 Set |
| 16204★ | 63-64 | 2Dr Sedan               | Full Power Window Kit | 1346.95 Set |
| 16206★ | 65-66 | 2Dr Hardtop             | Full Power Window Kit | 1346.95 Set |
| 16207★ | 65-66 | Convertible             | Full Power Window Kit | 1346.95 Set |
| 16211★ | 67-68 | 2Dr Hardtop/Convertible | Full Power Window Kit | 1346.95 Set |
| 16219★ | 70    | 2Dr Hardtop/Convertible | Full Power Window Kit | 1346.95 Set |

# Windows

## VENT WINDOW GLASS

| Part # | Year  | Model                      | Part         | Price     |
|--------|-------|----------------------------|--------------|-----------|
| 13228★ | 58    | 2-Dr Hardtop/Convertible   | Clear        | 35.95 Ea. |
| 13229★ | 58    | 2-Dr Hardtop/Convertible   | Tinted       | 35.95 Ea. |
| 13230★ | 58    | 2-Dr Hardtop/Convertible   | Gray Tinted  | 35.95 Ea. |
| 13248★ | 59-60 | 2-Dr Hardtop/Convertible   | Clear        | 35.95 Ea. |
| 13249★ | 59-60 | 2-Dr Hardtop/Convertible   | Tinted       | 35.95 Ea. |
| 13250★ | 59-60 | 2-Dr Hardtop/Convertible   | Gray Tinted  | 35.95 Ea. |
| 16569★ | 59-60 | El Camino                  | Clear        | 35.95 Ea. |
| 16570★ | 59-60 | El Camino                  | Green Tinted | 35.95 Ea. |
| 16571★ | 59-60 | El Camino                  | Gray Tinted  | 35.95 Ea. |
| 13281★ | 61-62 | 2-Dr Hardtop/Convertible   | Clear        | 35.95 Ea. |
| 13282★ | 61-62 | 2/4-Dr Hardtop/Convertible | Tinted       | 35.95 Ea. |
| 13283★ | 61-62 | 2/4-Dr Hardtop/Convertible | Gray Tinted  | 35.95 Ea. |
| 13284★ | 63-64 | 2/4-Dr Hardtop/Convertible | Clear        | 35.95 Ea. |
| 13285★ | 63-64 | 2/4-Dr Hardtop/Convertible | Tinted       | 35.95 Ea. |
| 13286★ | 63-64 | 2/4-Dr Hardtop/Convertible | Gray Tinted  | 35.95 Ea. |
| 13338★ | 65-66 | 2-Dr Hardtop LH            | Tinted       | 89.95 Ea. |
| 13339★ | 65-66 | 2-Dr Hardtop RH            | Tinted       | 89.95 Ea. |
| 13340★ | 65-66 | Convertible LH             | Tinted       | 89.95 Ea. |
| 13341★ | 65-66 | Convertible RH             | Tinted       | 89.95 Ea. |

## BACK GLASS

| Part # | Year  | Model                 | Part            | Price      |
|--------|-------|-----------------------|-----------------|------------|
| 13237★ | 58    | 2-Door Hardtop        | Tinted          | 369.95 Ea. |
| 13263★ | 59-60 | 2-Door Hardtop        | Tinted          | 339.95 Ea. |
| 13264★ | 59-60 | 2-Door Hardtop        | Gray Tinted     | 339.95 Ea. |
| 16575★ | 59-60 | El Camino             | Clear           | 309.95 Ea. |
| 16576★ | 59-60 | El Camino             | Green Tinted    | 309.95 Ea. |
| 16577★ | 59-60 | El Camino             | Gray Tinted     | 309.95 Ea. |
| 13305★ | 61    | 2-Door Hardtop        | Tinted          | 389.95 Ea. |
| 13306★ | 61    | 2-Door Hardtop        | Gray Tinted     | 389.95 Ea. |
| 13307★ | 62-64 | 2-Door Hardtop        | Tinted          | 329.95 Ea. |
| 13308★ | 62-64 | 2-Door Hardtop        | Gray Tinted     | 329.95 Ea. |
| 13352★ | 65-66 | 2-Door Hardtop        | Tinted          | 279.95 Ea. |
| 16484★ | 65-66 | Impala 2-Door Hardtop | Back Glass Gray | 279.95 Ea. |

## CHROME WINDOW FRAMES



| Part # | Year  | Model               | Part                       | Price      |
|--------|-------|---------------------|----------------------------|------------|
| 13056  | 63-64 | Hardtop/Convertible | Vent Window Frames         | 55.95 Pair |
| 15512  | 65-68 | Hardtop             | Vent Window Frames         | 75.95 Pair |
| 12992① | 58    | Impala 2-Dr Hardtop | Dr Window Frame LH         | 79.95 Ea.  |
| 12993① | 58    | Impala 2-Dr Hardtop | Dr Window Frame RH         | 79.95 Ea.  |
| 12994① | 58    | Bel 2-Dr Hardtop    | Dr Window Frame LH         | 79.95 Ea.  |
| 12995① | 58    | Bel 2-Dr Hardtop    | Dr Window Frame RH         | 79.95 Ea.  |
| 12996① | 58    | Convertible         | Dr Window Frame LH/RH      | 79.95 Ea.  |
| 12997① | 59-60 | Impala 2-Dr Hardtop | Dr Window Frame LH         | 79.95 Ea.  |
| 12998① | 59-60 | Impala 2-Dr Hardtop | Dr Window Frame RH         | 79.95 Ea.  |
| 12999① | 59-60 | Convertible         | Dr Window Frame LH/RH      | 79.95 Ea.  |
| 15502① | 61-62 | Bubble Top          | Dr Window Frame LH         | 79.95 Ea.  |
| 15503① | 61-62 | Bubble Top          | Dr Window Frame RH         | 79.95 Ea.  |
| 13000① | 61-64 | Impala 2-Dr Hardtop | Dr Window Frame LH         | 79.95 Ea.  |
| 13001① | 61-64 | Impala 2-Dr Hardtop | Dr Window Frame RH         | 79.95 Ea.  |
| 13002① | 61-64 | Convertible         | Dr Window Frame LH/RH      | 79.95 Ea.  |
| 13003① | 58    | Impala 2-Dr Hardtop | Quarter Window Frame LH/RH | 69.95 Ea.  |
| 13004① | 58    | Convertible         | Quarter Window Frame LH/RH | 99.95 Ea.  |
| 13005① | 59    | Convertible         | Quarter Window Frame LH/RH | 99.95 Ea.  |
| 13006① | 61-64 | Convertible         | Quarter Window Frame LH/RH | 99.95 Ea.  |

★ = special order non-stocking item, please allow 4-6 weeks for delivery.

Most glass items are special order items and we do not keep them in stock. All windshields and some back glass have to be shipped by truck freight.

# Windows

## DOOR WINDOW GLASS

| Part # | Year  | Model                          | Part         | Price      |
|--------|-------|--------------------------------|--------------|------------|
| 13231  | 58    | 2-Door Hardtop/<br>Convertible | Clear        | 55.95 Ea.  |
| 13232  | 58    | 2-Door Hardtop/<br>Convertible | Tinted       | 55.95 Ea.  |
| 13233  | 58    | 2-Door Hardtop/<br>Convertible | Gray Tinted  | 55.95 Ea.  |
| 13251  | 59-60 | 2-Door Hardtop                 | Clear        | 55.95 Ea.  |
| 13252  | 59-60 | 2-Door Hardtop                 | Tinted       | 55.95 Ea.  |
| 13253  | 59-60 | 2-Door Hardtop                 | Gray Tinted  | 55.95 Ea.  |
| 13254  | 59-60 | Convertible                    | Clear        | 55.95 Ea.  |
| 13255  | 59-60 | Convertible                    | Tinted       | 55.95 Ea.  |
| 13256  | 59-60 | Convertible                    | Gray Tinted  | 55.95 Ea.  |
| 16572  | 59-60 | El Camino                      | Clear        | 55.95 Ea.  |
| 16573  | 59-60 | El Camino                      | Green Tinted | 55.95 Ea.  |
| 16574  | 59-60 | El Camino                      | Gray Tinted  | 55.95 Ea.  |
| 13287  | 61    | 2-Door Hardtop                 | Clear        | 55.95 Ea.  |
| 13288  | 61    | 2-Door Hardtop                 | Tinted       | 55.95 Ea.  |
| 13289  | 61    | 2-Door Hardtop                 | Gray Tinted  | 55.95 Ea.  |
| 13290  | 62-64 | 2-Door Hardtop                 | Clear        | 55.95 Ea.  |
| 13291  | 62-64 | 2-Door Hardtop                 | Tinted       | 55.95 Ea.  |
| 13292  | 62-64 | 2-Door Hardtop                 | Gray Tinted  | 55.95 Ea.  |
| 13293  | 61-64 | Convertible                    | Clear        | 55.95 Ea.  |
| 13294  | 61-64 | Convertible                    | Tinted       | 55.95 Ea.  |
| 13295  | 61-64 | Convertible                    | Gray Tinted  | 55.95 Ea.  |
| 13342  | 65    | 2-Door Hardtop LH              | Tinted       | 169.95 Ea. |
| 13343  | 65    | 2-Door Hardtop RH              | Tinted       | 169.95 Ea. |
| 13344  | 66    | 2-Door Hardtop LH              | Tinted       | 169.95 Ea. |
| 13345  | 66    | 2-Door Hardtop RH              | Tinted       | 169.95 Ea. |
| 13346  | 66    | Convertible LH                 | Tinted       | 169.95 Ea. |
| 13347  | 66    | Convertible RH                 | Tinted       | 169.95 Ea. |

## DOOR GLASS ASSEMBLIES

|  |       |  |                        |            |
|--|-------|---|------------------------|------------|
| <b>15832</b>   |       | <b>15833</b>  |                        |            |
| Part #   | Year  | Model   | Part                   | Price      |
| 15832  | 62-64 | 2-Dr Hardtop  | Door Glass Assembly LH | 369.95 Ea. |
| 15833  | 62-64 | 2-Dr Hardtop  | Door Glass Assembly RH | 369.95 Ea. |

## 1958 GLASS SETS

| Part # | Year | Model                        | Part                      | Price      |
|--------|------|------------------------------|---------------------------|------------|
| 13238  | 58   | 2-Dr Hardtop/<br>Convertible | Clear 6-Pc Side Set       | 249.95 Set |
| 13239  | 58   | 2-Dr Hardtop/<br>Convertible | Tinted 6-Pc Side Set      | 249.95 Set |
| 13240  | 58   | 2-Dr Hardtop/<br>Convertible | Gray Tinted 6-Pc Side Set | 249.95 Set |
| 13241  | 58   | 2-Dr Hardtop                 | Clear 8-Pc Full Set       | 854.95 Set |
| 13242  | 58   | 2-Dr Hardtop                 | Tinted 8-Pc Full Set      | 854.95 Set |
| 13243  | 58   | 2-Dr Hardtop                 | Gray Tinted 8-Pc Full Set | 854.95 Set |
| 13244  | 58   | Convertible                  | Clear 7-Pc Full Set       | 614.95 Set |
| 13245  | 58   | Convertible                  | Tinted 7-Pc Full Set      | 614.95 Set |
| 13246  | 58   | Convertible                  | Gray Tinted 7-Pc Full Set | 614.95 Set |

★ = special order non-stocking item, please allow 4-6 weeks for delivery.

☞ = truck freight (call for shipping quote)

① = add \$8.95 handling per item

Most glass items are special order items and we do not keep them in stock. All windshields and some back glass have to be shipped by truck freight.

# Windows / Wipers

## 1959-60 GLASS SETS

| Part #  | Year  | Model        | Part                      | Price      |
|---------|-------|--------------|---------------------------|------------|
| 13265★  | 59-60 | 2-Dr Hardtop | Clear 6-Pc Side Set       | 249.95 Set |
| 13266★  | 59-60 | 2-Dr Hardtop | Tinted 6-Pc Side Set      | 249.95 Set |
| 13267★  | 59-60 | 2-Dr Hardtop | Gray Tinted 6-Pc Side Set | 249.95 Set |
| 13268★  | 59-60 | Convertible  | Clear 6-Pc Side Set       | 249.95 Set |
| 13269★  | 59-60 | Convertible  | Tinted 6-Pc Side Set      | 249.95 Set |
| 13270★  | 59-60 | Convertible  | Gray Tinted 6-Pc Side Set | 249.95 Set |
| 13271☞★ | 59-60 | 2-Dr Hardtop | Clear 8-Pc Full Set       | 804.95 Set |
| 13272☞★ | 59-60 | 2-Dr Hardtop | Tinted 8-Pc Full Set      | 804.95 Set |
| 13273☞★ | 59-60 | 2-Dr Hardtop | Gray Tinted 8-Pc Side Set | 804.95 Set |
| 13274☞★ | 59-60 | Convertible  | Clear 7-Pc Full Set       | 604.95 Set |
| 13275☞★ | 59-60 | Convertible  | Tinted 7-Pc Full Set      | 604.95 Set |
| 13276☞★ | 59-60 | Convertible  | Gray Tinted 7-Pc Side Set | 604.95 Set |
| 16228★  | 59-60 | El Camino    | Clear 6-Pc                | 699.95 Ea. |
| 16229★  | 59-60 | El Camino    | Tinted 6-Pc               | 699.95 Ea. |
| 16230★  | 59-60 | El Camino    | Gray 6-Pc                 | 699.95 Ea. |

## 1961-64 GLASS SETS

| Part #  | Year  | Model        | Part                      | Price      |
|---------|-------|--------------|---------------------------|------------|
| 13309★  | 61    | 2-Dr Hardtop | Clear 6-Pc Side Set       | 249.95 Set |
| 13310★  | 61    | 2-Dr Hardtop | Tinted 6-Pc Side Set      | 249.95 Set |
| 13311★  | 61    | 2-Dr Hardtop | Gray Tinted 6-Pc Side Set | 249.95 Set |
| 13312★  | 62    | 2-Dr Hardtop | Clear 6-Pc Side Set       | 249.95 Set |
| 13313★  | 62    | 2-Dr Hardtop | Tinted 6-Pc Side Set      | 249.95 Set |
| 13314★  | 62    | 2-Dr Hardtop | Gray Tinted 6-Pc Side Set | 249.95 Set |
| 13372★  | 63-64 | 2-Dr Hardtop | Clear 6-Pc Side Set       | 249.95 Set |
| 13373★  | 63-64 | 2-Dr Hardtop | Tinted 6-Pc Side Set      | 249.95 Set |
| 13374★  | 63-64 | 2-Dr Hardtop | Gray Tinted 6-Pc Side Set | 249.95 Set |
| 13315★  | 61-62 | Convertible  | Clear 6-Pc Side Set       | 249.95 Set |
| 13316★  | 61-62 | Convertible  | Tinted 6-Pc Side Set      | 249.95 Set |
| 13317★  | 61-62 | Convertible  | Gray Tinted 6-Pc Side Set | 249.95 Set |
| 13318★  | 63-64 | Convertible  | Clear 6-Pc Side Set       | 249.95 Set |
| 13319★  | 63-64 | Convertible  | Tinted 6-Pc Side Set      | 249.95 Set |
| 13320★  | 63-64 | Convertible  | Gray Tinted 6-Pc Side Set | 249.95 Set |
| 13321☞★ | 61    | 2-Dr Hardtop | Clear 8-Pc Full Set       | 854.95 Set |
| 13322☞★ | 61    | 2-Dr Hardtop | Tinted 8-Pc Full Set      | 854.95 Set |
| 13323☞★ | 61    | 2-Dr Hardtop | Gray Tinted 8-Pc Full Set | 854.95 Set |
| 13324☞★ | 62    | 2-Dr Hardtop | Clear 8-Pc Full Set       | 794.95 Set |

Continued on next column

## 1961-64 GLASS SETS-CONTINUED

| Part #  | Year  | Model        | Part                      | Price      |
|---------|-------|--------------|---------------------------|------------|
| 13325☞★ | 62    | 2-Dr Hardtop | Tinted 8-Pc Full Set      | 794.95 Set |
| 13326☞★ | 62    | 2-Dr Hardtop | Gray Tinted 8-Pc Full Set | 794.95 Set |
| 13327☞★ | 63-64 | 2-Dr Hardtop | Clear 8-Pc Full Set       | 664.95 Set |
| 13328☞★ | 63-64 | 2-Dr Hardtop | Tinted 8-Pc Full Set      | 664.95 Set |
| 13329☞★ | 63-64 | 2-Dr Hardtop | Gray Tinted 8-Pc Full Set | 664.95 Set |
| 13330☞★ | 61-62 | Convertible  | Clear 7-Pc Full Set       | 604.95 Set |
| 13331☞★ | 61-62 | Convertible  | Tinted 7-Pc Full Set      | 604.95 Set |
| 13332☞★ | 61-62 | Convertible  | Gray Tinted 7-Pc Full Set | 604.95 Set |
| 13333☞★ | 63-64 | Convertible  | Clear 7-Pc Full Set       | 505.95 Set |
| 13334☞★ | 63-64 | Convertible  | Tinted 7-Pc Full Set      | 505.95 Set |
| 13335☞★ | 63-64 | Convertible  | Gray Tinted 7-Pc Full Set | 505.95 Set |

## 1965-66 GLASS SETS

| Part #  | Year  | Model        | Part                 | Price      |
|---------|-------|--------------|----------------------|------------|
| 13353★  | 65    | 2-Dr Hardtop | Tinted 6-Pc Side Set | 644.95 Set |
| 13354★  | 66    | 2-Dr Hardtop | Tinted 6-Pc Side Set | 644.95 Set |
| 13355★  | 65-66 | Convertible  | Tinted 6-Pc Side Set | 644.95 Set |
| 13356☞★ | 65    | 2-Dr Hardtop | Tinted 8-Pc Full Set | 884.95 Set |
| 13357☞★ | 66    | 2-Dr Hardtop | Tinted 8-Pc Full Set | 884.95 Set |
| 13358☞★ | 65-66 | Convertible  | Tinted 7-Pc Full Set | 714.95 Set |

## WINDSHIELDS

| Part #  | Year  | Model                          | Part       | Price      |
|---------|-------|--------------------------------|------------|------------|
| 13227☞★ | 58    | 2-Door Hardtop/<br>Convertible | Tinted     | 399.95 Ea. |
| 13247☞★ | 59-60 | 2-Door Hardtop/<br>Convertible | Tinted     | 359.95 Ea. |
| 16568★☞ | 59-60 | El Camino                      | Clear 6-Pc | 699.95 Ea. |
| 13277☞★ | 61    | 2-Door Hardtop                 | Tinted     | 389.95 Ea. |
| 13278☞★ | 62    | 2-Door Hardtop                 | Tinted     | 389.95 Ea. |
| 13279☞★ | 61-62 | Convertible                    | Tinted     | 389.95 Ea. |
| 13280☞★ | 63-64 | 2-Door Hardtop/<br>Convertible | Tinted     | 295.95 Ea. |
| 13336☞★ | 65-66 | 2-Door Hardtop                 | Tinted     | 209.95 Ea. |
| 13337☞★ | 65-68 | Convertible                    | Tinted     | 209.95 Ea. |

★ = special order non-stocking item, please allow 4-6 weeks for delivery.  
☞ = truck freight (call for shipping quote)

Most glass items are special order items and we do not keep them in stock. All windshields and some back glass have to be shipped by truck freight.

# Windows / Wipers

## QUARTER WINDOW GLASS

| Part #   | Year  | Model                      | Part        | Price      |
|----------|-------|----------------------------|-------------|------------|
| 13234 ①★ | 58    | 2-Door Hardtop/Convertible | Clear       | 55.95 Ea.  |
| 13235 ①★ | 58    | 2-Door Hardtop/Convertible | Tinted      | 55.95 Ea.  |
| 13236 ①★ | 58    | 2-Door Hardtop/Convertible | Gray Tinted | 55.95 Ea.  |
| 13257 ①★ | 59-60 | 2-Door Hardtop             | Clear       | 55.95 Ea.  |
| 13258 ①★ | 59-60 | 2-Door Hardtop             | Tinted      | 55.95 Ea.  |
| 13259 ①★ | 59-60 | 2-Door Hardtop             | Gray Tinted | 55.95 Ea.  |
| 13260 ①★ | 59-60 | Convertible                | Clear       | 55.95 Ea.  |
| 13261 ①★ | 59-60 | Convertible                | Tinted      | 55.95 Ea.  |
| 13262 ①★ | 59-60 | Convertible                | Gray Tinted | 55.95 Ea.  |
| 13296 ①★ | 61    | 2-Door Hardtop             | Clear       | 55.95 Ea.  |
| 13297 ①★ | 61    | 2-Door Hardtop             | Tinted      | 55.95 Ea.  |
| 13298 ①★ | 61    | 2-Door Hardtop             | Gray Tinted | 55.95 Ea.  |
| 13299 ①★ | 62-64 | 2-Door Hardtop             | Clear       | 55.95 Ea.  |
| 13300 ①★ | 62-64 | 2-Door Hardtop             | Tinted      | 55.95 Ea.  |
| 13301 ①★ | 62-64 | 2-Door Hardtop             | Gray Tinted | 55.95 Ea.  |
| 13302 ①★ | 61-64 | Convertible                | Clear       | 55.95 Ea.  |
| 13303 ①★ | 61-64 | Convertible                | Tinted      | 55.95 Ea.  |
| 13304 ①★ | 61-64 | Convertible                | Gray Tinted | 55.95 Ea.  |
| 13348 ①★ | 65-66 | 2-Door Hardtop LH          | Tinted      | 149.95 Ea. |
| 13349 ①★ | 65-66 | 2-Door Hardtop RH          | Tinted      | 149.95 Ea. |
| 13350 ①★ | 65-66 | Convertible LH             | Tinted      | 149.95 Ea. |
| 13351 ①★ | 65-66 | Convertible RH             | Tinted      | 149.95 Ea. |

## WIPER ARMS & BLADES

| Part # | Year  | Model       | Part               | Price      |
|--------|-------|-------------|--------------------|------------|
| 12727  | 59-60 | Hardtop     | Wiper Arm LH       | 22.95 Ea.  |
| 12728  | 59-60 | Hardtop     | Wiper Arm RH       | 22.95 Ea.  |
| 12729  | 59-60 | Sedan/Wagon | Wiper Arm LH       | 22.95 Ea.  |
| 12730  | 59-60 | Sedan/Wagon | Wiper Arm RH       | 22.95 Ea.  |
| 12197  | 61-64 | All         | Wiper Arm LH       | 16.95 Ea.  |
| 12198  | 61-64 | All         | Wiper Arm RH       | 16.95 Ea.  |
| 16064  | 65-67 | All         | Wiper Arms         | 45.95 Pair |
| 5799   | 59-67 | All         | Wiper Blade        | 16.95 Ea.  |
| 2537   | 58-60 | All         | Wiper Saver Covers | 19.95 Pair |

## WIPER MOTOR PARTS

| Part # | Year  | Model         | Part                          | Price    |
|--------|-------|---------------|-------------------------------|----------|
| 12199  | 58    | All           | Wiper Motor Mounting Pad      | 5.95 Ea. |
| 12200  | 59-70 | All w/Single  | Wiper Drive Shaft Sealing Cap | 4.50 Ea. |
| 12201  | 62-64 | All w/2-Speed | Wiper Drive Shaft Sealing Cap | 5.95 Ea. |

## WINDSHIELD WIPER NOZZLES

| Part # | Year  | Model             | Part                       | Price      |
|--------|-------|-------------------|----------------------------|------------|
| 5791   | 58    | All               | Wiper Tower Nozzles        | 5.00 Pair  |
| 16285  | 61-62 | Impala/Full Size  | Washer Nozzles/Zinc Coated | 45.95 Pair |
| 16286  | 63-64 | Impala/ Full Size | Washer Nozzles/Zinc Coated | 45.95 Pair |
| 16287  | 65-66 | Impala/ Full Size | Washer Nozzles/Zinc Coated | 45.95 Pair |

## WIPER SWITCHES AND KNOBS

| Part # | Year  | Model   | Part         | Price     |
|--------|-------|---------|--------------|-----------|
| 13076  | 59-63 | 2-Speed | Wiper Switch | 45.95 Ea. |
| 15259  | 62-63 | 1-Speed | Wiper Switch | 45.95 Ea. |
| 15131  | 64    | 1-Speed | Wiper Switch | 45.95 Ea. |
| 15347  | 64    | 2-Speed | Wiper Switch | 41.95 Ea. |
| 15132  | 65-66 | 1-Speed | Wiper Switch | 45.95 Ea. |
| 13387  | 65-66 | 2-Speed | Wiper Switch | 45.95 Ea. |
| 16148  | 67    | 2-Speed | Wiper Switch | 45.95 Ea. |
| 16298  | 67    | 2-Speed | Wiper Switch | 45.95 Ea. |
| 15122  | 68    | 2-Speed | Wiper Switch | 45.95 Ea. |
| 15689  | 65-66 | Impala  | Wiper Knob   | 18.95 Ea. |
| 12208  | 67    | Impala  | Wiper Knob   | 9.95 Ea.  |
| 16507  | 69-70 | All     | Wiper Switch | 89.95 Ea. |

## WIPER ESCUTCHEONS

| Part # | Year | Model | Part                    | Price      |
|--------|------|-------|-------------------------|------------|
| 12981  | 58   | All   | Wiper Bezel Escutcheons | 25.95 Pair |

★ = special order non-stocking item, please allow 4-6 weeks for delivery.  
 ① = add \$8.95 handling per item

# Washer / Wiring

## WINDSHIELD WASHER KITS

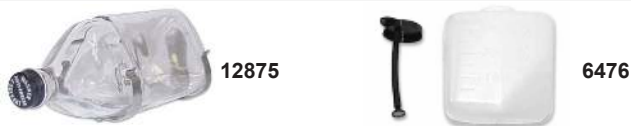

| Part # | Year  | Model | Part                        | Price     |
|--------|-------|-------|-----------------------------|-----------|
| 12875  | 61-67 | All   | Washer Refill Jar Kit       | 44.95 Kit |
| 6476   | 62-69 | All   | Washer Reservoir Bottle Kit | 15.95 Kit |

## WINDSHIELD WASHER PARTS



| Part # | Year  | Model | Part                 | Price     |
|--------|-------|-------|----------------------|-----------|
| 6957   | 68-69 | All   | Washer Jar Bracket   | 10.95 Ea. |
| 6477   | 68-70 | All   | Washer Reservoir Cap | 4.00 Ea.  |
| 6549   | 67-70 | All   | Washer Bottle Filter | 5.00 Ea.  |

## WINDSHIELD WASHER HOSES



| Part # | Year  | Model | Part                       | Price     |
|--------|-------|-------|----------------------------|-----------|
| 12202  | 58    | All   | Windshield Washer Hose Kit | 11.95 Kit |
| 12203  | 59-60 | All   | Windshield Washer Hose Kit | 10.95 Kit |
| 12204  | 61    | All   | Windshield Washer Hose Kit | 11.95 Kit |
| 12205  | 62    | All   | Windshield Washer Hose Kit | 11.95 Kit |
| 12206  | 63    | All   | Windshield Washer Hose Kit | 11.95 Kit |
| 12207  | 64    | All   | Windshield Washer Hose Kit | 11.95 Kit |



Co-owners Michael Manning and Frank Colonna founded American Autowire in 1983. Back then, it was a two-man operation working from Michael's basement in Laurel Springs, NJ. Now, Michael and Frank are still at the helm along with Jim Cardona, but with over 70 employees and 38,000 square feet of space at the American Autowire manufacturing facility in Bellmawr, NJ. They have become the premier automotive electrical manufacturer for OEM/Restoration, Modified Restoration, and Street Rod/Custom vehicles, currently offering 6 different product lines of wiring harnesses, accessories, and parts that cater to all types of automotive projects.

American Autowire produces a huge selection of wiring harnesses, accessories, kits, and components that any true rodder or restorer can appreciate. We offer over 9,000 original restoration wiring harness, switches, battery cables, and spark plug wire set combinations in our Factory Fit® product line, complete modified restoration kits in our Classic Update Series, and provide integrated fuse panel and modular fuse panel street rod wiring through our Power Plus, Builder, and Highway series.

All of our wiring harnesses are manufactured exclusively by American Auto Wire!

If you do not have a wiring diagram and are purchasing wiring, we advise you to purchase a diagram. This will make replacing your wiring an easier task. Diagrams are listed on page 68 in this catalog.

## TACHOMETER HARNESSES

| Part # | Year  | Model              | Part               | Price     |
|--------|-------|--------------------|--------------------|-----------|
| 12647  | 61-62 | All                | Tachometer Harness | 50.95 Ea. |
| 12648  | 63    | In Dash Tachometer | Tachometer Harness | 39.95 Ea. |
| 12649  | 64    | In Dash Tachometer | Tachometer Harness | 39.95 Ea. |
| 12650  | 64    | Column Mount       | Tachometer Harness | 39.95 Ea. |
| 12651  | 65    | In Dash Tachometer | Tachometer Harness | 45.95 Ea. |
| 12652  | 66    | In Dash Tachometer | Tachometer Harness | 39.95 Ea. |
| 12653  | 65-66 | Column Tachometer  | Tachometer Harness | 45.95 Ea. |

## HARNESS CLIPS

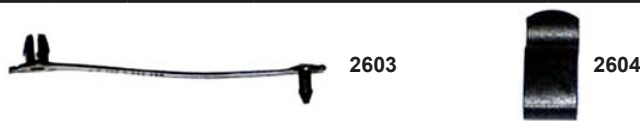

| Part # | Year  | Model | Part              | Price   |
|--------|-------|-------|-------------------|---------|
| 2603   | 58-70 | All   | Plastic Loop Clip | .25 Ea. |
| 2604   | 58-70 | All   | Metal U-Type Clip | .25 Ea. |

## DOMELIGHT HARNESSES

| Part # | Year  | Model              | Part  | Price     |
|--------|-------|--------------------|---|-----------|
| 12644  | 58    | All                | Dome Light Harness                                | 22.95 Ea. |
| 12645  | 59    | All                | Dome Light Feed & Ground                          | 28.95 Ea. |
| 12646  | 65-67 | All                | Dome Light Harness                                | 35.95 Ea. |
| 12654  | 59-60 | All                | Dash Courtesy Light Harness                       | 45.95 Ea. |
| 4001   | 58-70 | All                | Under Dash Crtsy Light Kit                        | 26.95 Kit |
| 12655  | 60    | Impala/Bel-Air     | Courtesy Light Harness (For Dual Overhead Lights) | 45.95 Ea. |
| 12656  | 61-64 | All                | Courtesy Light Harness (For Side Roofrail Lamps)  | 45.95 Ea. |
| 12657  | 62    | All                | Courtesy Light Harness (For Dual Quarter Lights)  | 45.95 Ea. |
| 12658  | 62    | All                | Courtesy Light Harness (For Dual Quarter Lights)  | 45.95 Ea. |
| 12660  | 65-66 | Caprice            | Quarter Corner Courtesy Light Harness             | 45.95 Ea. |
| 12661  | 65-66 | All Except Caprice | Quarter Corner Courtesy Light Harness             | 45.95 Ea. |
| 12662  | 65-66 | 4Dr Hardtop        | Quarter Corner Courtesy Light Harness             | 45.95 Ea. |
| 12663  | 65-67 | Convertible        | Dash Courtesy Light Harness                       | 45.95 Ea. |
| 12664  | 66-67 | Caprice Hardtop    | Quarter Corner Courtesy Light Harness             | 45.95 Ea. |
| 12665  | 67    | Impala Hardtop     | Quarter Corner Courtesy Light Harness             | 45.95 Ea. |
| 12666  | 67    | Impala Sedan       | Quarter Corner Courtesy Light Harness             | 45.95 Ea. |

# Wiring

## ENGINE HARNESSES



12211



12220



12232



12248



12259

| Part # | Year | Model                          | Part                               | Price      |
|--------|------|--------------------------------|------------------------------------|------------|
| 12211  | 58   | 6-Cylinder Automatic           | Engine Harness                     | 85.95 Ea.  |
| 12212  | 58   | 6-Cylinder Standard            | Engine Harness                     | 85.95 Ea.  |
| 12213  | 58   | 283 Automatic                  | Engine Harness                     | 75.95 Ea.  |
| 12214  | 58   | 283 Standard                   | Engine Harness                     | 85.95 Ea.  |
| 12215  | 58   | 283 Fuel Injection Automatic   | Engine Harness                     | 95.95 Ea.  |
| 12216  | 58   | 283 Fuel Injection Standard    | Engine Harness                     | 75.95 Ea.  |
| 12217  | 58   | 348 Automatic                  | Engine Harness                     | 75.95 Ea.  |
| 12218  | 58   | 348 Standard                   | Engine Harness                     | 75.95 Ea.  |
| 15835  | 58   | V8 Small Block HEI w/Automatic | Engine Harness                     | 95.95 Ea.  |
| 15836  | 58   | V8 Small Block HEI w/Standard  | Engine Harness                     | 105.95 Ea. |
| 12219  | 58   | All                            | Engine Harness Starter Jumper Wire | 25.95 Ea.  |
| 12220  | 59   | 6-Cylinder                     | Engine Harness                     | 85.95 Ea.  |
| 12221  | 59   | 283                            | Engine Harness                     | 75.95 Ea.  |
| 12223  | 59   | 348 w/Solid Lifters            | Engine Harness                     | 75.95 Ea.  |
| 12222  | 59   | 348 w/o Solid Lifters          | Engine Harness                     | 85.95 Ea.  |
| 15837  | 59   | V8 Small Block HEI             | Engine Harness                     | 95.95 Ea.  |
| 12224  | 60   | 6-Cylinder                     | Engine Harness                     | 85.95 Ea.  |
| 12225  | 60   | V8 Except 348                  | Engine Harness                     | 75.95 Ea.  |
| 12226  | 60   | 348 w/Solid Lifters            | Engine Harness                     | 75.95 Ea.  |
| 12222  | 60   | 348 w/o Solid Lifters          | Engine Harness                     | 85.95 Ea.  |
| 15838  | 60   | V8 Small Block HEI             | Engine Harness                     | 95.95 Ea.  |
| 12227  | 61   | 6-Cylinder                     | Engine Harness                     | 95.95 Ea.  |
| 12228  | 61   | V8 Except 348/409              | Engine Harness                     | 75.95 Ea.  |
| 12229  | 61   | 348 w/o Solid Lifters          | Engine Harness                     | 75.95 Ea.  |
| 12230  | 61   | 348/409 w/ Solid Lifters       | Engine Harness                     | 75.95 Ea.  |
| 15839  | 61   | V8 Small Block HEI             | Engine Harness                     | 95.95 Ea.  |
| 12231  | 62   | 6-Cylinder                     | Engine Harness                     | 95.95 Ea.  |
| 12232  | 62   | 283/327                        | Engine Harness                     | 75.95 Ea.  |
| 12233  | 62   | 409                            | Engine Harness                     | 75.95 Ea.  |
| 15840  | 62   | V8 Small Block HEI             | Engine Harness                     | 95.95 Ea.  |
| 12234  | 63   | 6-Cylinder                     | Engine Harness                     | 95.95 Ea.  |
| 12235  | 63   | 283/327                        | Engine Harness                     | 75.95 Ea.  |
| 12236  | 63   | 409                            | Engine Harness                     | 85.95 Ea.  |
| 15841  | 63   | V8 Small Block HEI             | Engine Harness                     | 95.95 Ea.  |

| Part # | Year  | Model                                    | Part           | Price      |
|--------|-------|--|----------------|------------|
| 12237  | 64    | 6-Cylinder                               | Engine Harness | 95.95 Ea.  |
| 12238  | 64    | 283/327                                  | Engine Harness | 80.95 Ea.  |
| 12239  | 64    | 409                                      | Engine Harness | 80.95 Ea.  |
| 15842  | 64    | V8 Small Block HEI                       | Engine Harness | 100.95 Ea. |
| 12240  | 65-66 | 6-Cylinder w/Gauges                      | Engine Harness | 110.95 Ea. |
| 12241  | 65-66 | 6-Cylinder w/AC & Gauges                 | Engine Harness | 140.95 Ea. |
| 12242  | 65-66 | 6-Cylinder w/Warning Lights              | Engine Harness | 110.95 Ea. |
| 12243  | 65-66 | 6-Cylinder w/AC & Lights                 | Engine Harness | 150.95 Ea. |
| 12244  | 65-66 | 283/327 w/Gauges                         | Engine Harness | 100.95 Ea. |
| 12246★ | 65-66 | 283/327 w/Warning Lights                 | Engine Harness | 100.95 Ea. |
| 12247  | 65-66 | 283/327 w/AC & Lights                    | Engine Harness | 140.95 Ea. |
| 15843  | 65-66 | V8 Small Block HWI w/Warning Lights      | Engine Harness | 120.95 Ea. |
| 15844  | 65-66 | V8 Small Block HEI w/Warning Lights & AC | Engine Harness | 160.95 Ea. |
| 15845  | 65-66 | V8 Small Block HEI w/Gauges              | Engine Harness | 120.95 Ea. |
| 15846  | 65-66 | V8 Small Block HEI w/Gauges & AC         | Engine Harness | 160.95 Ea. |
| 12248  | 65    | 396 w/Gauges                             | Engine Harness | 100.95 Ea. |
| 12249  | 65    | 396 w/AC & Gauges                        | Engine Harness | 140.95 Ea. |
| 12250  | 65    | 396 w/Warning Lights                     | Engine Harness | 100.95 Ea. |
| 12251  | 65    | 396 w/AC & Lights                        | Engine Harness | 150.95 Ea. |
| 12252  | 65    | 409 w/Gauges                             | Engine Harness | 110.95 Ea. |
| 12253  | 65    | 409 w/AC & Gauges                        | Engine Harness | 150.95 Ea. |
| 12254  | 65    | 409 w/Warning Lights                     | Engine Harness | 110.95 Ea. |
| 12255  | 65    | 409 w/AC & Lights                        | Engine Harness | 140.95 Ea. |
| 15847  | 65    | V8 396 HEI w/Warning Lights              | Engine Harness | 120.95 Ea. |
| 15848  | 65    | V8 HEI w/Warning Lights & AC             | Engine Harness | 170.95 Ea. |
| 15849  | 65    | V8 396 HEI w/Gauges                      | Engine Harness | 120.95 Ea. |

# Wiring

## ENGINE HARNESSES

| Part # | Year | Model                                    | Part           | Price      | Part # | Year  | Model   | Part           | Price      |
|--------|------|--|----------------|------------|--------|-------|---|----------------|------------|
| 15850  | 65   | V8 396 HEI w/Gauges & AC                 | Engine Harness | 160.95 Ea. | 12271  | 68-69 | 6-Cylinder w/Warning Lights w/Carb Idle Stop Solenoid | Engine Harness | 125.95 Ea. |
| 12256  | 66   | 396/427 w/Gauges                         | Engine Harness | 100.95 Ea. | 12272  | 68    | 307/327 Warning Lights                                | Engine Harness | 105.95 Ea. |
| 12257  | 66   | 396/427 w/AC & Gauges                    | Engine Harness | 150.95 Ea. | 12273  | 68    | 396/427 Warning Lights                                | Engine Harness | 105.95 Ea. |
| 12258★ | 66   | 396/427 w/Warning Lights                 | Engine Harness | 100.95 Ea. | 12274  | 68    | V8 w/Gauges   | Engine Harness | 105.95 Ea. |
| 12259  | 66   | 396/427 w/AC & Lights                    | Engine Harness | 150.95 Ea. | 12275  | 68    | V8 w/AC & Gauges                                      | Engine Harness | 105.95 Ea. |
| 15851  | 66   | V8 396/427 HEI w/Warning Lights          | Engine Harness | 120.95 Ea. | 15863  | 68    | V8 Small Block HEI w/Warning Lights                   | Engine Harness | 125.95 Ea. |
| 15852  | 66   | V8 396/427 HEI w/Warning Lights & AC     | Engine Harness | 170.95 Ea. | 15864  | 68    | V8 Small Block HEI w/Gauges                           | Engine Harness | 125.95 Ea. |
| 15854  | 66   | V8 396/427 HEI w/Gauges & AC             | Engine Harness | 170.95 Ea. | 15865  | 68    | V8 Small Block HEI w/Gauges & AC                      | Engine Harness | 125.95 Ea. |
| 12260  | 67   | 6-Cylinder w/ Gauges                     | Engine Harness | 125.95 Ea. | 15866  | 68    | V8 396/427 w/ Warning Lights                          | Engine Harness | 125.95 Ea. |
| 12261  | 67   | 6-Cylinder w/AC & Lights                 | Engine Harness | 125.95 Ea. | 12276  | 69    | 327/350 w/Warning Lights                              | Engine Harness | 110.95 Ea. |
| 12262  | 67   | 283/327 w/ Gauges                        | Engine Harness | 105.95 Ea. | 12277  | 69    | 327/350 w/AC & Lights                                 | Engine Harness | 110.95 Ea. |
| 12263  | 67   | 283/327 w/AC & Gauges                    | Engine Harness | 105.95 Ea. | 12278  | 69    | 396/427 w/Warning Lights                              | Engine Harness | 110.95 Ea. |
| 12264  | 67   | 283/327 Warning Lighs                    | Engine Harness | 105.95 Ea. | 15867  | 69    | V8 Small Block HEI w/Warning Lights                   | Engine Harness | 130.95 Ea. |
| 12265  | 67   | 283/327 w/AC & Lights                    | Engine Harness | 105.95 Ea. | 15868  | 69    | V8 Small Block HEI w/Warning Lights & AC              | Engine Harness | 130.95 Ea. |
| 12266  | 67   | 396/427 w/Gauges                         | Engine Harness | 105.95 Ea. | 12279  | 70    | 6-Cylinder Automatic                                  | Engine Harness | 185.95 Ea. |
| 12267  | 67   | 396/427 w/AC & Gauges                    | Engine Harness | 105.95 Ea. | 12280  | 70    | 6-Cylinder Standard                                   | Engine Harness | 185.95 Ea. |
| 12268  | 67   | 396/427 Warning Lights                   | Engine Harness | 105.95 Ea. | 12281  | 70    | 350/400 Automatic                                     | Engine Harness | 175.95 Ea. |
| 12269  | 67   | 396/427 w/AC & Lights                    | Engine Harness | 105.95 Ea. | 12282  | 70    | 350/400 Automatic w/ AC                               | Engine Harness | 165.95 Ea. |
| 15855  | 67   | V8 Small Block HEI w/Warning Lights & AC | Engine Harness | 125.95 Ea. | 12283  | 70    | 350/400 TH400 w/AC                                    | Engine Harness | 185.95 Ea. |
| 15856  | 67   | V8 Small Block HEI w/Warning Lights & AC | Engine Harness | 125.95 Ea. | 12284  | 70    | 350/400 Standard                                      | Engine Harness | 185.95 Ea. |
| 15857  | 67   | V8 Small Block HEI w/Gauges              | Engine Harness | 125.95 Ea. | 12285  | 70    | 402/454 w/TH400                                       | Engine Harness | 185.95 Ea. |
| 15858  | 67   | V8 Small Block HEI w/Gauges & AC         | Engine Harness | 125.95 Ea. | 12286  | 70    | 402/454 w/TH400                                       | Engine Harness | 185.95 Ea. |
| 15859  | 67   | V8 396/427 HEI w/Warning Lights          | Engine Harness | 125.95 Ea. | 15869  | 70    | V8 Small Block HEI w/Standard                         | Engine Harness | 205.95 Ea. |
| 15860  | 67   | V8 396/427 HEI w/Warning Lights & AC     | Engine Harness | 125.95 Ea. | 15870  | 70    | V8 Small Block HEI w/Automatic                        | Engine Harness | 195.95 Ea. |
| 15861  | 67   | V8 396/427 HEI w/ Gauges                 | Engine Harness | 125.95 Ea. | 15871  | 70    | V8 Small Block HEI w/Automatic & AC                   | Engine Harness | 185.95 Ea. |
| 15862  | 67   | V8 396/427 HEI w/ Gauges & AC            | Engine Harness | 125.95 Ea. | 15872  | 70    | V8 402/454 w/Automatic                                | Engine Harness | 205.95 Ea. |
| 12270  | 68   | 6-Cylinder w/Warning Lights              | Engine Harness | 125.95 Ea. | 15873  | 70    | V8 402/454 w/Automatic & AC                           | Engine Harness | 205.95 Ea. |

★ = special order non-stocking item, please allow 4-6 weeks for delivery.

# Wiring

## FRONT LINE HARNESSES



12293



12302



12304



12313



12336



6464

| Part # | Year | Model                              | Part  | Price      |
|--------|------|------------------------------------|---|------------|
| 12287  | 58   | 6-Cylinder                         | Front Light Harness   | 119.95 Ea. |
| 12288  | 58   | 6-Cylinder HD Generator            | Front Light Harness   | 119.95 Ea. |
| 12289  | 58   | V8 Stock Generator                 | Front Light Harness   | 109.95 Ea. |
| 12290  | 58   | V8 HD Generator                    | Front Light Harness   | 119.95 Ea. |
| 12291  | 58   | V8 Internal Regulated Alternator   | Front Light Harness   | 124.95 Ea. |
| 12292  | 58   | w/Air Suspension                   | Front Light Harness   | 119.95 Ea. |
| 12293  | 58   | All                                | Parking Light Bar Harness                                       | 49.95 Ea.  |
| 12294  | 59   | 6-Cylinder                         | Front Light Harness   | 149.95 Ea. |
| 12295  | 59   | 6-Cylinder HD Generator            | Front Light Harness   | 149.95 Ea. |
| 12296  | 59   | V8 HD Generator                    | Front Light Harness   | 139.95 Ea. |
| 12297  | 59   | V8 Stock Generator                 | Front Light Harness   | 139.95 Ea. |
| 12298  | 59   | V8 Internal Regulated Alternator   | Front Light Harness   | 149.95 Ea. |
| 12299  | 60   | 6-Cylinder                         | Front Light Harness   | 169.95 Ea. |
| 12300  | 60   | 6-Cylinder HD Generator            | Front Light Harness   | 169.95 Ea. |
| 12301  | 60   | V8 Stock Generator                 | Front Light Harness   | 149.95 Ea. |
| 12302  | 60   | V8 HD Generator                    | Front Light Harness   | 169.95 Ea. |
| 15874  | 60   | V8 w/Internal Regulated Alternator | Front Light Harness   | 169.95 Ea. |
| 12303  | 61   | 6-Cylinder                         | Front Light Harness   | 189.95 Ea. |
| 12304  | 61   | 6-Cylinder HD Generator            | Front Light Harness   | 189.95 Ea. |
| 12305  | 61   | V8 Stock Generator                 | Front Light Harness   | 179.95 Ea. |
| 12306  | 61   | V8 HD Generator                    | Front Light Harness   | 189.95 Ea. |
| 15875  | 61   | V8 W/Internal Regulated Alternator | Front Light Harness   | 189.95 Ea. |
| 12307  | 62   | 6-Cylinder                         | Front Light Harness   | 189.95 Ea. |
| 12308  | 62   | V8 HD Generator                    | Front Light Harness   | 179.95 Ea. |
| 12309  | 62   | V8 Internal Regulated Alternator   | Front Light Harness   | 179.95 Ea. |
| 12310  | 62   | V8 External Regulated Alternator   | Front Light Harness <b>Must Use 1985 or Earlier Alternator.</b> | 189.95 Ea. |
| 12311  | 62   | V8 Alternator                      | Front Light Harness <b>For Use w/Stock Regulator.</b>           | 179.95 Ea. |
| 12312  | 63   | 6-Cylinder                         | Front Light Harness   | 189.95 Ea. |
| 12313  | 63   | V8                                 | Front Light Harness   | 169.95 Ea. |
| 15876  | 63   | V8 w/Internal Regulated Alternator | Front Light Harness   | 189.95 Ea. |
| 12314  | 64   | 6-Cylinder                         | Front Light Harness   | 199.95 Ea. |
| 12315  | 64   | V8                                 | Front Light Harness   | 169.95 Ea. |

| Part # | Year | Model   | Part                          | Price      |
|--------|------|---|-------------------------------|------------|
| 15877  | 64   | V8 w/Internal Regulated Alternator                  | Front Light Harness           | 189.95 Ea. |
| 12316  | 65   | 6-Cylinder Gauges                                   | Front Light Harness           | 229.95 Ea. |
| 12317  | 65   | 6-Cylinder Lights                                   | Front Light Harness           | 229.95 Ea. |
| 12318  | 65   | V8 Gauges   | Front Light Harness           | 189.95 Ea. |
| 12319  | 65   | V8 Lights   | Front Light Harness           | 189.95 Ea. |
| 15878  | 65   | V8 w/Warning  | Front Light Harness           | 209.95 Ea. |
| 15879  | 65   | V8 w/Gauges w/Internal Regulated Alternator         | Front Light Harness           | 209.95 Ea. |
| 12320  | 66   | 6-Cylinder Gauges                                   | Front Light Harness           | 229.95 Ea. |
| 12321  | 66   | 6-Cylinder Lights                                   | Front Light Harness           | 229.95 Ea. |
| 12322  | 66   | V8 Gauges   | Front Light Harness           | 199.95 Ea. |
| 12323  | 66   | V8 Lights   | Front Light Harness           | 199.95 Ea. |
| 15880  | 66   | V8 w/Warning w/Internal Regulated Alternator        | Front Light Harness           | 219.95 Ea. |
| 15881  | 66   | V8 w/Gauges w/Internal Regulated Alternator         | Front Light Harness           | 219.95 Ea. |
| 12324  | 67   | 6-Cylinder w/T78 Running Lights                     | Front Light Harness           | 239.95 Ea. |
| 12325  | 67   | V8 Gauges   | Front Light Harness           | 209.95 Ea. |
| 12326  | 67   | V8 Gauges w/T78 Running Lights                      | Front Light Harness           | 219.95 Ea. |
| 12327  | 67   | V8 Lights   | Front Light Harness           | 209.95 Ea. |
| 12328  | 67   | V8 Warning Lights w/T78 Running Lights              | Front Light Harness           | 209.95 Ea. |
| 12329  | 67   | All   | T78 Light to Switch Extension | 12.95 Ea.  |
| 15882  | 67   | V8 w/Warning Lights w/Internal Regulated Alternator | Front Light Harness           | 229.95 Ea. |
| 15883  | 67   | V8 w/Gauges w/Internal Regulated Alternator         | Front Light Harness           | 229.95 Ea. |
| 12330  | 68   | 6-Cylinder Lights                                   | Front Light Harness           | 249.95 Ea. |
| 12331  | 68   | 6-Cylinder Warning Lights w/Fender Lights           | Front Light Harness           | 249.95 Ea. |
| 12332  | 68   | V8 Gauges   | Front Light Harness           | 229.95 Ea. |
| 12333  | 68   | V8 Gauges w/Fender Lights                           | Front Light Harness           | 229.95 Ea. |
| 12334  | 68   | V8 Warning Lights                                   | Front Light Harness           | 229.95 Ea. |
| 12335  | 68   | V8 Warning Lights w/Fender Lights                   | Front Light Harness           | 229.95 Ea. |
| 15884  | 68   | V8 w/Warning Lights w/Internal Regulated Alternator | Front Light Harness           | 239.95 Ea. |

# Wiring

## FRONT LINE HARNESSES-CONTINUED

| Part # | Year | Model   | Part                | Price      | Part # | Year  | Model  | Part   | Price      |
|--------|------|---|---------------------|------------|--------|-------|--|--|------------|
| 15885  | 68   | V8 s/Gauges<br>w/Internal Regulated<br>Alternator | Front Light Harness | 249.95 Ea. | 15886  | 69    | V8 Small Block<br>w/Internal Regulated<br>Alternator | Front Light Harness  | 259.95 Ea. |
| 12336  | 69   | 6-Cylinder  | Front Light Harness | 249.95 Ea. | 15887  | 69    | V8 396/427 w/<br>Internal Regulated<br>Alternator    | Front Light Harness  | 259.95 Ea. |
| 12337★ | 69   | 6-Cylinder<br>w/Retractable<br>Headlight Covers   | Front Light Harness | 259.95 Ea. | 12343  | 70    | 6-Cylinder   | Front Light Harness  | 249.95 Ea. |
| 12338  | 69   | 327/350   | Front Light Harness | 239.95 Ea. | 12344  | 70    | V8   | Front Light Harness  | 259.95 Ea. |
| 12339  | 69   | 327/350<br>w/Retractable<br>Headlight Covers      | Front Light Harness | 239.95 Ea. | 15888  | 70    | V8 Small Block<br>w/Internal Regulated<br>Alternator | Front Light Harness  | 269.95 Ea. |
| 12340  | 69   | 396/427   | Front Light Harness | 239.95 Ea. | 6464   | 63-71 | All  | Alternator<br>Convertible Kit<br><b>External To Internal<br/>Regulator Must<br/>Be 1985 Or Earlier<br/>Alternator.</b> | 21.95 Ea.  |
| 12341  | 69   | 396/427 Gauges                                    | Front Light Harness | 249.95 Ea. |        |       |  |  |            |
| 12342  | 69   | 396/427<br>w/Retractable<br>Headlight Covers      | Front Light Harness | 239.95 Ea. |        |       |  |  |            |

## UNDER DASH HARNESSES



12345



12351



12352



12364



12370



12389

| Part # | Year | Model                                       | Part                  | Price      | Part # | Year | Model                               | Part                                  | Price      |
|--------|------|---|-----------------------|------------|--------|------|-------------------------------------|---------------------------------------|------------|
| 12345  | 58   | All   | Under Dash<br>Harness | 308.95 Ea. | 12360  | 62   | Impala Automatic                    | Under Dash<br>Harness                 | 330.95 Ea. |
| 12347  | 59   | Biscayne Automatic                          | Under Dash<br>Harness | 330.95 Ea. | 12361  | 62   | Biscayne Standard                   | Under Dash<br>Harness                 | 343.95 Ea. |
| 12346  | 59   | Bel-Air/Impala/<br>El Camino<br>w/Automatic | Under Dash<br>Harness | 308.95 Ea. | 12362  | 62   | Bel-Air Standard                    | Under Dash<br>Harness                 | 330.95 Ea. |
| 12349  | 59   | Biscayne Standard                           | Under Dash<br>Harness | 330.95 Ea. | 12363  | 62   | Impala Standard                     | Under Dash<br>Harness                 | 330.95 Ea. |
| 12348  | 59   | Bel-Air/Impala/<br>El Camino w/Standard     | Under Dash<br>Harness | 308.95 Ea. | 12364  | 63   | Biscayne Automatic                  | Under Dash<br>Harness                 | 375.95 Ea. |
| 12350  | 60   | Automatic                                   | Under Dash<br>Harness | 308.95 Ea. | 12365  | 63   | Bel-Air Automatic                   | Under Dash<br>Harness                 | 361.95 Ea. |
| 12351  | 60   | Standard                                    | Under Dash<br>Harness | 308.95 Ea. | 12366  | 63   | Impala Automatic                    | Under Dash<br>Harness                 | 348.95 Ea. |
| 12352  | 61   | Biscayne Automatic                          | Under Dash<br>Harness | 350.95 Ea. | 12367  | 63   | Biscayne Standard                   | Under Dash<br>Harness                 | 361.95 Ea. |
| 12353  | 61   | Bel-Air Automatic                           | Under Dash<br>Harness | 343.95 Ea. | 12368  | 63   | Bel-Air Standard                    | Under Dash<br>Harness                 | 361.95 Ea. |
| 12354  | 61   | Impala Automatic                            | Under Dash<br>Harness | 330.95 Ea. | 12369  | 63   | Impala Standard                     | Under Dash<br>Harness                 | 348.95 Ea. |
| 12355  | 61   | Biscayne Standard                           | Under Dash<br>Harness | 350.95 Ea. | 12370  | 64   | Biscayne Automatic<br>Column Shift  | Under Dash<br>Harness                 | 343.95 Ea. |
| 12356  | 61   | Bel-Air Standard                            | Under Dash<br>Harness | 343.95 Ea. | 12371  | 64   | Biscayne Standard<br>Column Shift   | Under Dash<br>Harness                 | 350.95 Ea. |
| 12357  | 61   | Impala Standard                             | Under Dash<br>Harness | 330.95 Ea. | 12372  | 64   | Bel-Air Automatic Col-<br>umn Shift | Under Dash<br>Harness                 | 343.95 Ea. |
| 12358  | 62   | Biscayne Automatic                          | Under Dash<br>Harness | 343.95 Ea. | 12373  | 64   | Bel-Air Standard Col-<br>umn Shift  | Under Dash<br>Harness                 | 350.95 Ea. |
| 12359  | 62   | Bel-Air Automatic                           | Under Dash<br>Harness | 343.95 Ea. | 12374  | 64   | Impala Automatic                    | Column Shift<br>Under Dash<br>Harness | 330.95 Ea. |

# Wiring

## UNDER DASH HARNESES-CONTINUED

| Part # | Year | Model  | Part               | Price      | Part # | Year | Model  | Part               | Price      |
|--------|------|--|--------------------|------------|--------|------|--|--------------------|------------|
| 12375  | 64   | Impala w/AC Automatic Column Shift                         | Under Dash Harness | 330.95 Ea. | 12399  | 67   | w/AC Automatic Column Shift w/Warning Light w/ Courtesy Lights   | Under Dash Harness | 441.95 Ea. |
| 12376  | 64   | Impala All Console Shift                                   | Under Dash Harness | 330.95 Ea. | 12400  | 67   | Automatic Console Shift w/Gauges                                 | Under Dash Harness | 441.95 Ea. |
| 12377  | 64   | Impala w/AC Console Shift                                  | Under Dash Harness | 330.95 Ea. | 12401  | 67   | w/AC Automatic Console Shift w/Gauges                            | Under Dash Harness | 458.95 Ea. |
| 12378  | 64   | Impala Standard Column Shift                               | Under Dash Harness | 343.95 Ea. | 12402  | 67   | Automatic Console Shift w/Warning Lights                         | Under Dash Harness | 458.95 Ea. |
| 12379  | 65   | Automatic Column Shift With Warning Lights                 | Under Dash Harness | 387.95 Ea. | 12403  | 67   | w/AC Automatic Console Shift w/Warning Lights                    | Under Dash Harness | 458.95 Ea. |
| 12380  | 65   | w/AC Automatic Column Shift w/Warning Lights               | Under Dash Harness | 387.95 Ea. | 12404  | 67   | w/AC Standard Console Shift w/Gauges                             | Under Dash Harness | 458.95 Ea. |
| 12381  | 65   | Automatic Column Shift w/Warning Lights w/ Courtesy Lights | Under Dash Harness | 387.95 Ea. | 12405  | 67   | Standard Console Shift w/Warning Lights                          | Under Dash Harness | 470.95 Ea. |
| 12382  | 65   | Automatic Console Shift w/ Gauges w/Courtesy Lights        | Under Dash Harness | 387.95 Ea. | 12406  | 67   | w/AC Standard Console Shift w/Warning Lights                     | Under Dash Harness | 458.95 Ea. |
| 12383  | 65   | w/AC Automatic Console Shift w/Gauges w/Courtesy Lights    | Under Dash Harness | 387.95 Ea. | 12407  | 68   | Automatic Column Shift w/Gauges                                  | Under Dash Harness | 470.95 Ea. |
| 12384  | 65   | Standard Column Shift w/Warning Lights                     | Under Dash Harness | 402.95 Ea. | 12408  | 68   | w/AC Automatic Column Shift With Gauges                          | Under Dash Harness | 460.95 Ea. |
| 12385  | 65   | Standard Column Shift w/Warning Lights w/Courtesy Lights   | Under Dash Harness | 402.95 Ea. | 12409  | 68   | Automatic Column Shift w/Warning Lights                          | Under Dash Harness | 470.95 Ea. |
| 12386  | 65   | Standard Console Shift w/Gauges w/Courtesy Lights          | Under Dash Harness | 387.95 Ea. | 12410  | 68   | Caprice Automatic Column Shift w/Warning Light w/Courtesy Lights | Under Dash Harness | 483.95 Ea. |
| 12387  | 65   | w/AC Standard Console Shift w/Gauges w/Courtesy Lights     | Under Dash Harness | 387.95 Ea. | 12411  | 68   | Caprice Automatic Column Shift w/Warning Light w/Courtesy Lights | Under Dash Harness | 483.95 Ea. |
| 12388  | 66   | Automatic Column Shift w/Warning Lights                    | Under Dash Harness | 429.95 Ea. | 12412  | 68   | Automatic Console Shift w/Gauges                                 | Under Dash Harness | 470.95 Ea. |
| 12389  | 66   | w/AC Automatic Column Shift w/Warning Lights               | Under Dash Harness | 429.95 Ea. | 12413  | 68   | w/AC Automatic Console Shift w/Gauges                            | Under Dash Harness | 470.95 Ea. |
| 12390  | 66   | Automatic Console Shift                                    | Under Dash Harness | 429.95 Ea. | 12414  | 68   | Automatic Console Shift w/Warning Lights                         | Under Dash Harness | 495.95 Ea. |
| 12391  | 66   | w/AC Automatic Console Shift                               | Under Dash Harness | 429.95 Ea. | 12418  | 68   | Standard Column Shift w/Warning Lights                           | Under Dash Harness | 495.95 Ea. |
| 12392  | 66   | Standard Column Shift w/Warning Lights                     | Under Dash Harness | 445.95 Ea. | 12415  | 68   | Standard Console Shift w/Gauges                                  | Under Dash Harness | 470.95 Ea. |
| 12393  | 66   | Standard Console Shift                                     | Under Dash Harness | 429.95 Ea. | 12416  | 68   | w/AC Standard Console Shift w/Gauges                             | Under Dash Harness | 470.95 Ea. |
| 12394  | 66   | w/AC Standard Console Shift                                | Under Dash Harness | 445.95 Ea. | 12417  | 68   | Standard Console Shift w/Warning Lights                          | Under Dash Harness | 495.95 Ea. |
| 12395  | 67   | Automatic Column Shift w/Gauges                            | Under Dash Harness | 458.95 Ea. | 12419  | 69   | w/AC Automatic w/Under Dash Courtesy Lights                      | Under Dash Harness | 495.95 Ea. |
| 12396  | 67   | w/AC Automatic Column Shift w/Gauges                       | Under Dash Harness | 458.95 Ea. | 12420  | 69   | Automatic Column Shift   | Under Dash Harness | 515.95 Ea. |
| 12397  | 67   | Automatic Column Shift w/Warning Lights                    | Under Dash Harness | 441.95 Ea. | 12422  | 69   | Automatic Console Shift  | Under Dash Harness | 515.95 Ea. |
| 12398  | 67   | Automatic Column Shift w/Warning Light w/Courtesy Lights   | Under Dash Harness | 458.95 Ea. | 12423  | 69   | w/AC Automatic Console Shift                                     | Under Dash Harness | 495.95 Ea. |
|        |      |  |                    |            | 12424  | 69   | Standard   | Under Dash Harness | 495.95 Ea. |

# Wiring

## UNDER DASH HARNESES-CONTINUED

|       |    |                             |                    |            |       |    |   |                    |            |
|-------|----|-----------------------------|--------------------|------------|-------|----|---|--------------------|------------|
| 12425 | 69 | Standard w/AC               | Under Dash Harness | 495.95 Ea. | 12428 | 70 | Column Shift w/Clock w/Courtesy Lights          | Under Dash Harness | 540.95 Ea. |
| 12426 | 70 | Automatic Column Shift      | Under Dash Harness | 560.95 Ea. | 12429 | 70 | Automatic Column Shift w/Headlight Delay Timing | Under Dash Harness | 550.95 Ea. |
| 12427 | 70 | w/AC Automatic Column Shift | Under Dash Harness | 550.95 Ea. |       |    |   |                    |            |

## DASH CLUSTER HARNESES



12430



12432



12434

|       |    |                  |                      |           |       |    |                  |                      |           |
|-------|----|------------------|----------------------|-----------|-------|----|------------------|----------------------|-----------|
| 12430 | 63 | Biscayne/Bel-Air | Dash Cluster Harness | 95.95 Ea. | 12433 | 64 | Impala           | Dash Cluster Harness | 79.95 Ea. |
| 12431 | 63 | Impala           | Dash Cluster Harness | 85.95 Ea. | 12434 | 65 | w/Gauges         | Dash Cluster Harness | 85.95 Ea. |
| 12432 | 64 | Biscayne/Bel-Air | Dash Cluster Harness | 89.95 Ea. | 12435 | 65 | w/Warning Lights | Dash Cluster Harness | 95.95 Ea. |

## CONSOLE HARNESES



12667



12669



12671

|       |    |                       |                                   |           |       |       |           |                            |           |
|-------|----|-----------------------|-----------------------------------|-----------|-------|-------|-----------|----------------------------|-----------|
| 12667 | 62 | Impala SS Hardtop     | Console Harness w/Courtesy Lights | 42.95 Ea. | 12677 | 67    | Automatic | Console Harness            | 60.95 Ea. |
| 12668 | 62 | Impala SS Convertible | Console Harness w/Courtesy Lights | 42.95 Ea. | 12678 | 67    | Standard  | Console Harness            | 35.95 Ea. |
| 12669 | 63 | Impala SS             | Console Harness w/Courtesy Lights | 42.95 Ea. | 12679 | 68    | Automatic | Console Harness            | 60.95 Ea. |
| 12670 | 64 | All                   | Console Harness                   | 20.95 Ea. | 12680 | 68    | Standard  | Console Harness            | 35.95 Ea. |
| 12671 | 65 | Automatic             | Console & Clock Harness           | 42.95 Ea. | 12681 | 63    | Standard  | Console Door Light Harness | 23.95 Ea. |
| 12672 | 65 | Standard              | Console & Clock Harness           | 39.95 Ea. | 12682 | 64    | All       | Console Door Light Harness | 23.95 Ea. |
| 12673 | 66 | Automatic             | Console Harness                   | 50.95 Ea. | 12683 | 66-69 | All       | Console Door Light Harness | 18.95 Ea. |
| 12674 | 66 | Automatic             | Console & Console Gauge Harness   | 90.95 Ea. | 12684 | 63    | All       | Console Extension Harness  | 32.95 Ea. |
| 12675 | 66 | Standard              | Console Harness                   | 39.95 Ea. | 12685 | 64    | Automatic | Console Extension Harness  | 55.95 Ea. |
| 12676 | 66 | Standard              | Console & Console Gauge Harness   | 85.95 Ea. | 12686 | 64    | Standard  | Console Extension Harness  | 29.95 Ea. |

## TAILLIGHT HARNESES



12436



12440



12446



12449



12550



12558

| Part # | Year | Model                       | Part              | Price      | Part # | Year | Model                            | Part                    | Price      |
|--------|------|-----------------------------|-------------------|------------|--------|------|----------------------------------|-------------------------|------------|
| 12436  | 58   | Biscayne/Bel-Air            | Taillight Harness | 135.95 Ea. | 12440  | 59   | Biscayne (Except Sedan Delivery) | Front Taillight Harness | 105.95 Ea. |
| 12437  | 58   | Delray                      | Taillight Harness | 135.95 Ea. | 12441  | 59   | Bel-Air/Impala                   | Front Taillight Harness | 105.95 Ea. |
| 12438  | 58   | Impala (Except Convertible) | Taillight Harness | 135.95 Ea. | 12442  | 59   | Impala Convertible               | Front Taillight Harness | 159.95 Ea. |
| 12439  | 58   | Impala Convertible          | Taillight Harness | 169.95 Ea. |        |      |                                  |                         |            |

# Wiring

## TAILLIGHT HARNESES-CONTINUED

| Part # | Year  | Model   | Part                    | Price      | Part # | Year | Model                                   | Part                        | Price      |
|--------|-------|---|-------------------------|------------|--------|------|---|-----------------------------|------------|
| 12443  | 59    | Nomad/Sedan/ Delivery/ Brookwood 2/4-Dr Wagon & El Camino | Front Taillight Harness | 80.95 Ea.  | 12568  | 61   | Bel-Air                                 | Rear Taillight Harness      | 50.95 Ea.  |
| 12444  | 59    | Kingswood 4-Dr Wagon w/Power Tailgate                     | Front Taillight Harness | 199.95 Ea. | 12569  | 61   | Bel-Air                                 | Deck Lid Harness            | 45.95 Ea.  |
| 12445  | 59    | Parkwood Wagon  | Front Taillight Harness | 105.95 Ea. | 12570  | 61   | Impala                                  | Rear Taillight Harness      | 50.95 Ea.  |
| 12446  | 59    | Biscayne/Bel-Air/Impala                                   | Rear Taillight Harness  | 69.95 Ea.  | 12571  | 61   | Impala Convertible                      | Rear Taillight Harness      | 55.95 Ea.  |
| 12447  | 59    | Sedan Delivery  | Rear Taillight Harness  | 99.95 Ea.  | 12572  | 61   | Impala                                  | Deck Lid Harness            | 55.95 Ea.  |
| 12448  | 59    | Brookwood Wagon/ El Camino/Parkwood 4-Dr Wagon            | Rear Taillight Harness  | 99.95 Ea.  | 12573  | 61   | All                                     | Rear Body Extension Harness | 45.95 Ea.  |
| 12449  | 59    | Sedan Delivery/ El Camino                                 | Tailgate Harness        | 69.95 Ea.  | 12574  | 62   | Biscayne 2-Door                         | Front Taillight Harness     | 120.95 Ea. |
| 15816  | 59-60 | All   | Taillight Socket        | 4.95 Ea.   | 12575  | 62   | Biscayne 4-Door                         | Front Taillight Harness     | 124.95 Ea. |
| 12550  | 60    | Biscayne  | Front Taillight Harness | 105.95 Ea. | 12576  | 62   | Bel-Air Hardtop                         | Front Taillight Harness     | 124.95 Ea. |
| 12551  | 60    | Bel-Air/Impala  | Front Taillight Harness | 105.95 Ea. | 12577  | 62   | Bel-Air 2-Dr Sedan                      | Front Taillight Harness     | 124.95 Ea. |
| 12552  | 60    | Impala Convertible (1st Design)                           | Front Taillight Harness | 159.95 Ea. | 12578  | 62   | Bel-Air 4-Dr Sedan                      | Front Taillight Harness     | 124.95 Ea. |
| 12553  | 60    | Impala Convertible (2nd Design)                           | Front Taillight Harness | 159.95 Ea. | 12579  | 62   | Bel-Air                                 | Deck Lid Harness            | 45.95 Ea.  |
| 12554  | 60    | Brook. 2-Door Wagon/ Sedan Delivery/ El Camino            | Front Taillight Harness | 93.95 Ea.  | 12580  | 62   | Bel-Air w/Backup Lights                 | Deck Lid Harness            | 45.95 Ea.  |
| 12555  | 60    | Brookwood 4-Door Wagon                                    | Front Taillight Harness | 105.95 Ea. | 12581  | 62   | Impala Hardtop                          | Front Taillight Harness     | 124.95 Ea. |
| 12556  | 60    | Kingswood 4-Dr Wagon w/Power Tailgate                     | Front Taillight Harness | 199.95 Ea. | 12583  | 62   | Impala Convertible                      | Front Taillight Harness     | 169.95 Ea. |
| 12557  | 60    | Nomad & Parkwood 4-Dr Wagon                               | Front Taillight Harness | 99.95 Ea.  | 12584  | 62   | Impala Sedan                            | Front Taillight Harness     | 124.95 Ea. |
| 12558  | 60    | Biscayne/Bel-Air  | Rear Taillight Harness  | 79.95 Ea.  | 12585  | 62   | Impala                                  | Deck Lid Harness            | 60.95 Ea.  |
| 12559  | 60    | Impala  | Rear Taillight Harness  | 79.95 Ea.  | 12586  | 62   | All                                     | Rear Body Extension Harness | 45.95 Ea.  |
| 12560  | 60    | El Camino/Sedan/ Delivery/Brookwood & Parkwood Wagons     | Rear Taillight Harness  | 129.95 Ea. | 12587  | 63   | Biscayne/Bel-Air 2-Dr w/Backup Lights   | Taillight Harness           | 145.95 Ea. |
| 12561  | 60    | Nomad   | Rear Taillight Harness  | 129.95 Ea. | 12588  | 63   | Biscayne/Bel-Air 2-Dr w/o Backup Lights | Taillight Harness           | 145.95 Ea. |
| 12562  | 61    | Biscayne 2-Door   | Front Taillight Harness | 79.95 Ea.  | 12589  | 63   | Biscayne/Bel-Air 4-Dr w/Backup Lights   | Taillight Harness           | 145.95 Ea. |
| 12563  | 61    | Biscayne 4-Door   | Front Taillight Harness | 79.95 Ea.  | 12590  | 63   | Biscayne/Bel-Air 4-Dr w/o Backup Lights | Taillight Harness           | 145.95 Ea. |
| 12564  | 61    | Bel-Air/Impala 2-Dr                                       | Front Taillight Harness | 69.95 Ea.  | 12591  | 63   | Biscayne/Bel-Air                        | Deck Lid Harness            | 45.95 Ea.  |
| 12565  | 61    | Bel-Air/Impala 4-Dr                                       | Front Taillight Harness | 69.95 Ea.  | 12592  | 63   | Biscayne/Bel-Air w/Backup Lights        | Deck Lid Harness            | 55.95 Ea.  |
| 12566  | 61    | Impala Convertible  | Front Taillight Harness | 139.95 Ea. | 12593  | 63   | Biscayne 4-Door/ Bel-Air Wagon          | Tailgate Harness            | 59.95 Ea.  |
| 12567  | 61    | Biscayne  | Rear Taillight Harness  | 50.95 Ea.  | 12594  | 63   | Impala 2-Dr Hardtop                     | Taillight Harness           | 145.95 Ea. |
|        |       |   |                         |            | 12596  | 63   | Impala 4-Dr Hardtop                     | Taillight Harness           | 145.95 Ea. |

# Wiring

## TAILLIGHT HARNESSES-CONTINUED

| Part # | Year | Model  | Part                  | Price      | Part # | Year  | Model   | Part                           | Price      |
|--------|------|--|-----------------------|------------|--------|-------|---|--------------------------------|------------|
| 12595  | 63   | Impala Convertible                                   | Taillight Harness     | 169.95 Ea. | 12623  | 66    | Caprice Hardtop   | Taillight Harness              | 139.95 Ea. |
| 12597  | 63   | Impala   | Rear Deck Lid Harness | 55.95 Ea.  | 12624  | 67    | Biscayne  | Taillight Harness              | 149.95 Ea. |
| 12598  | 63   | Impala 4-Dr Wagon                                    | Tailgate Harness      | 99.95 Ea.  | 12625  | 67    | Impala 2-Dr Hardtop   | Taillight Harness              | 149.95 Ea. |
| 12599  | 63   | Impala 4-Dr Wagon w/Power Tailgate                   | Tailgate Harness      | 129.95 Ea. | 12626  | 67    | Impala Convertible  | Taillight Harness              | 149.95 Ea. |
| 12600  | 64   | Biscayne 2-Dr & Bel-Air 4-Dr Sedan w/o Backup Lights | Taillight Harness     | 149.95 Ea. | 12627  | 67    | Bel-Air/Impala Sedan Impala 4-Dr Hardtop                      | Taillight Harness              | 149.95 Ea. |
| 12601  | 64   | Biscayne 2-Dr w/o Trunk Lights                       | Taillight Harness     | 149.95 Ea. | 12628  | 67    | Caprice Hardtop   | Taillight Harness              | 149.95 Ea. |
| 12602  | 64   | Biscayne 4-Dr w/o Trunk Lights                       | Taillight Harness     | 149.95 Ea. | 12629  | 67    | Caprice Sedan   | Taillight Harness              | 149.95 Ea. |
| 12603  | 64   | Biscayne 2-Door & Bel-Air Sedan w/Backup Lights      | Taillight Harness     | 149.95 Ea. | 15817  | 61-67 | All   | Taillight Socket               | 5.95 Ea.   |
| 12604  | 64   | Biscayne 4-Door & Bel-Air Sedan w/Backup Lights      | Taillight Harness     | 149.95 Ea. | 12630  | 68    | Impala Hardtop  | Taillight Intermediate Harness | 120.95 Ea. |
| 12605  | 64   | Bel-Air 2-Door Sedan w/o Backup Lights               | Taillight Harness     | 149.95 Ea. | 12631  | 68    | Impala Convertible  | Taillight Intermediate Harness | 120.95 Ea. |
| 12606  | 64   | Biscayne/Bel-Air w/Backup Lights                     | Deck Lid Harness      | 50.95 Ea.  | 12632  | 68    | Impala Sedan  | Taillight Intermediate Harness | 120.95 Ea. |
| 12607  | 64   | Biscayne/Bel-Air w/o Backup Lights                   | Deck Lid Harness      | 45.95 Ea.  | 12633  | 68    | Caprice Hardtop   | Taillight Intermediate Harness | 120.95 Ea. |
| 12608  | 64   | Impala Hardtop                                       | Taillight Harness     | 149.95 Ea. | 12634  | 68    | Caprice/Biscayne 4-Door Sedan                                 | Taillight Intermediate Harness | 120.95 Ea. |
| 12609  | 64   | Impala Convertible                                   | Taillight Harness     | 185.95 Ea. | 12635  | 68    | Biscayne/Bel-Air 2/4-Dr Sedan                                 | Taillight Rear Harness         | 129.95 Ea. |
| 12610  | 64   | Impala 4-Dr Sedan                                    | Taillight Harness     | 149.95 Ea. | 12636  | 68    | Impala Hardtop  | Taillight Rear Harness         | 129.95 Ea. |
| 12611  | 64   | Impala   | Deck Lid Harness      | 60.95 Ea.  | 12637  | 68    | Impala Convertible/Sedan/Custom Coupe/Caprice Hardtop & Sedan | Taillight Rear Harness         | 129.95 Ea. |
| 12612  | 65   | Biscayne/Bel-Air                                     | Taillight Harness     | 131.95 Ea. | 12638  | 69    | Impala/Caprice Hardtop  | Taillight Intermediate Harness | 120.95 Ea. |
| 12613  | 65   | Bel-Air  | Deck Lid Harness      | 45.95 Ea.  | 12639  | 69    | Caprice 4-Dr  | Taillight Intermediate Harness | 129.95 Ea. |
| 12614  | 65   | Impala Hardtop                                       | Taillight Harness     | 131.95 Ea. | 12640  | 69    | Biscayne/Bel-Air  | Taillight Harness              | 129.95 Ea. |
| 12615  | 65   | Impala Convertible                                   | Taillight Harness     | 131.95 Ea. | 12641  | 69    | Impala/Caprice  | Taillight Harness              | 129.95 Ea. |
| 12616  | 65   | Impala Sedan   | Taillight Harness     | 131.95 Ea. | 12642  | 70    | Impala Convertible  | Taillight Intermediate Harness | 149.95 Ea. |
| 12617  | 65   | Impala Hardtop                                       | Deck Lid Harness      | 60.95 Ea.  | 12643  | 70    | Caprice Sport Sedan   | Taillight Intermediate Harness | 149.95 Ea. |
| 12618  | 65   | Impala Convertible/Sedan                             | Deck Lid Harness      | 60.95 Ea.  |        |       |   |                                |            |
| 12619  | 66   | Biscayne/Bel-Air                                     | Taillight Harness     | 139.95 Ea. |        |       |   |                                |            |
| 12620  | 66   | Impala Hardtop                                       | Taillight Harness     | 139.95 Ea. |        |       |   |                                |            |
| 12621  | 66   | Impala Convertible                                   | Taillight Harness     | 139.95 Ea. |        |       |   |                                |            |
| 12622  | 66   | Impala/Caprice Sedan                                 | Taillight Harness     | 139.95 Ea. |        |       |   |                                |            |



**15588**  
**61-64 ALL**

## CLASSIC UPDATE WIRING HARNESS KIT

| Part # | Year  | Model       | Part                      |            |
|--------|-------|-------------|---------------------------|------------|
| 15916  | 59-60 | Impala      | Classic Update Wiring Kit | 669.95 Kit |
| 15588  | 61-64 | All         | Classic Update Wiring Kit | 609.95 Kit |
| 16048  | 65    | All         | Classic Update Wiring Kit | 759.95 Kit |
| 16049  | 66-68 | All         | Classic Update Wiring Kit | 699.95 Kit |
| 16300  | 61-62 | Convertible | Top Power Feed Harness    | 55.95 Ea   |
| 16301  | 63    | Convertible | Top Power Feed Harness    | 55.95 Ea   |
| 16302  | 64    | Convertible | Top Power Feed Harness    | 55.95 Ea   |

What makes the Classic Update Series harness kit better than the competition? The Classic Update Series design philosophy is to build complete “full function” systems and engineer them for easy access, easy installation, and connectivity with common update accessories, all while allowing for future expansion.

Each kit is a completely new design engineered around the specification and physical dimension of your car or truck, as well as the space constraint imposed by many aftermarket accessories vying for the limited space under the dash. These kits are not generic street rod products. Superior design has given the builder complete flexibility to use original stock switches and components as well as Custom Update accessories such as: Dakota Digital instruments, RainGear wiper systems, Vintage Air heat and AC systems, Ididit and Flaming River steering columns, and late model GM tilt steering columns.

The fuse box was chosen for its adaptability in mounting configurations and its ability to handle the increased current loads demanded by power accessories such as power windows, power seats, power door locks, cruise control, etc. It is a proven GM design that incorporates heavy duty circuit bussing. There is no circuit board in this high-power fuse box assembly, as the potential power demands are too high for a circuit board design. It is the attention to detail that removes the engineering exercise from the builder and makes installation much smoother.

**Warning: This wiring kit will not support an ammeter of any form. There are no instructions included on how to wire up an ammeter.**

### TECHNICAL SPECIFICATIONS AND FEATURES

- Fuse box incorporates 18 fused circuits and expansion capability for 11 additional power circuits. Fuse box measures 4" x 6" and is molded in resistant nylon 6/6. All necessary mounting hardware is included.
- Fuse link protection on fuse panel power feed.
- Circuit breaker capability on power circuit.
- High heat and abrasion resistant XLPE wire withstands -60°F to 275°F. GM wire color coding system.
- Wire circuit inkjet printed every 3 inches.
- Wire circuit take-off points predetermined to clear under dash accessories, allowing pretermination of most circuit branches and plug-in installation of most circuits.
- Standard turn flasher, four-way hazard flasher, and horn relay mounted on fuse panel.
- 8-gauge alternator power lead wire supplied with fuse panel.
- Alternator connector supplied for GM “SI” series internally regulated alternators and “one wire” alternators.
- Original boot and tube assemblies with original light socket connectors included for installation into existing or reproduction taillight housings. Even custom applications require these assemblies for weather protection.
- Terminals and connectors are provided for all dome light and door jamb switches cover two and four door models.
- Front lighting includes headlight connectors, headlight bucket grommets, connections front parking and directional lights.
- Complete wiring for updated GM steering column, turn signals and hazard switch.
- Mating connector and terminals supplied to adapt to original steering column. Ignition switch connectors supplied for GM columns with ignition switch in column.
- Engine wiring for points type and HEI distributors. Power and tachometer connectors supplied for GM HEI distributors.
- Gauge sender leads are provided for fuel, water temperature, oil pressure, voltmeter, and tachometer.
- Power wiring for electric engine fan, fuel pump, windows, door locks, seats, cruise control, and accessory radio included.
- Instrument cluster disconnect built into under dash harness for complete flexibility in gauge cluster section. All original terminals, connectors and light sockets are supplied for original cluster gauge wiring.
- Cluster disconnect also supports any custom gauge configuration.
- Late model GM headlight switch included.
- Floor mounted dimmer included.
- New ignition switch included.
- Fully detailed installation instructions and wiring.



**3855 HWY 15 SERIES KIT**  
\$469.95 EACH



**3856 HWY 22 SERIES KIT**  
\$389.95 EACH

## HIGHWAY SERIES UNIVERSAL WIRING HARNESS KIT

### HIGHWAY 15 FEATURES:

- Modular wiring system.
- 15 power circuits supported through 8 fuses and 1 circuit breaker.
- Panel protected with a 175-amp Mega-Fuse junction block with a 10-gauge panel feed wire.
- Nylon mechanically secured panel containing secondary push-back locks, has a 4-1/2" x 4-1/2" footprint, 3" in height, and mounted on a (G10) non-conductive epoxy base.
- All power buss bars are constructed of 6-gauge copper.
- All wires are constructed from heat resistant (-60°F to 275°F) GXL heavy-wall wire with laser printed circuit identification every 2 inches.
- GM color coded wires for ease of installation.
- All power circuit wires are 12-gauge constructed.
- New front-loaded vibration-proof self-locking (Hook's Law) screw-down terminal connection.
- Kit contains 2 relays (Horn, Turn Signal & 40-amp Electric Fan or Fuel Pump).
- Turn signal and hazard flasher circuits provided.
- 8-gauge alternator feed wire provided.
- The kit is set up for a GM "SI" internally regulated alternator or GM 1-wire.
- Alternator diode is also provided.
- Kit includes 3 (In-dash Ignition, Headlight & Alum. Knob and Floor Dimmer) switches.
- GM in-column ignition switch connectors provided, along with 3-7/8" GM steering column connectors with male and female terminals.
- Plugs directly in most 69-74 GM columns and most aftermarket steering columns, or use the terminals and connector provided to mate to any column.
- Limited spare circuits available.

### HIGHWAY 22 FEATURES:

- Modular wiring system.
- 22 power circuits supported through 15 fuses and 1 circuit breaker.
- Battery and accessory power tap studs provided for system expansion.
- Panel protected with a 175-amp Mega-Fuse junction block with a 10-gauge panel feed wire.
- Nylon mechanically secured panel containing secondary push-back locks, has a 7-1/2" x 4-1/2" footprint, 3-3/8" in height, and mounted on a (G10) non-conductive epoxy base.
- All power buss bars are constructed of 6-gauge copper.
- All wires are constructed from heat resistant (-60°F to 275°F) GXL heavy-wall wire with laser printed circuit identification every 2 inches.
- GM color coded wires for ease of installation.
- All power circuit wires are 12-gauge constructed.
- New front-loaded vibration-proof self-locking (Hook's Law) screw-down terminal connection.
- Dedicated battery and ignition circuits for electronic fuel injection (EFI).
- Kit contains 3 relays (Horn, Turn Signal & 40-amp Electric Fan or Fuel Pump).
- Turn signal and hazard flasher circuits provided.
- 8-gauge alternator feed wire provided.
- The kit is set up for a GM "SI" internally regulated alternator or GM 1-wire.
- Alternator diode is also provided.
- Kit includes 3 (In-dash Ignition, Headlight & Alum. Knob and Floor Dimmer) switches.
- GM in-column ignition switch connectors provided, along with 3-7/8" GM steering column connectors with male and female terminals.
- Plugs directly in most 69-74 GM columns and most aftermarket steering columns, or use the terminals and connector provided to mate to any column.
- Spare circuits available for power windows, locks, etc.

**Wiring for: Engine compartment:** (for both series) oil pressure, water temp, tach, starter, neutral safety, brake switch, ignition switch, distributor (GM HEI or Points), coil, main power and alternator. **Chassis wiring:** fuel pump, electric fan, headlights, running lights, brake lights, 3rd brake light, directional, license plate, radio, heat & AC, and wipers.

**Instructions:** Detailed cookbook-style color illustrated (CAD) installation instructions provided. Full color schematic of overall vehicle wiring along with individual harness sub-kit instructions for trouble-free installation.

# Insulation / Tilt Columns

## HEAT INSULATION



2248



2265



2266

The Insulator is a quality-made, moisture-resistant heat and sound barrier. It is a 4' x 6' 3/8" sheet of foil-backed insulation that has hundreds of uses in automobiles, boats, and RVs including:

- Heat insulation between firewall and headers or mainfolds
- Heat insulation between floorpan and carpet
- Sound deadener between floorpan and carpet
- Sound deadener in the headliner
- Sound deadener in the doors
- Sound deadener in the trunk

Don't forget about the spray adhesive and seam tape. These two products will help you complete the installation of the Insulpad insulation sheet.

| Part # | Year  | Model | Part               | Price          |
|--------|-------|-------|--------------------|----------------|
| 2248   | 58-70 | All   | Insulator Pad      | 29.95 Per Roll |
| 2265   | 58-70 | All   | Sticky-Stuff Spray | 10.95 Per Can  |
| 2266   | 58-70 | All   | Seam Tape          | 6.95 Per Roll  |

## HUSHMAT SOUND INSULATION



### Restoring a MuscleCar? Building a Street Rod? Installing a Sound System in your vehicle?

HushMat vibration damping, thermal insulation, sound absorption and tape materials create a quiet, cool & comfortable ride. HushMat is manufactured right here in the USA.

| Part #  | Year  | Model         | Part                              | Price       |
|---------|-------|---------------|-----------------------------------|-------------|
| 4050    | 55-57 | All           | Hush Mat 4-Pc (12X12) Starter Kit | 45.95 Kit   |
| 4051    | 55-57 | All           | Hush Mat 10-Pc (12X23) Trunk Kit  | 189.95 Kit  |
| 4052    | 55-57 | All           | Hush Mat 30-Pc (12X23) Bulk Kit   | 399.95 Kit  |
| 16536★🚗 | 58    | Hardtop/Sedan | Complete Hushmat Insulation Kit   | 1089.95 Kit |
| 16537★🚗 | 59-60 | Hardtop/Sedan | Complete Hushmat Insulation Kit   | 749.95 Kit  |
| 16538★🚗 | 59-60 | El Camino     | Complete Hushmat Insulation Kit   | 469.95 Kit  |
| 16539★🚗 | 61-64 | Hardtop/Sedan | Complete Hushmat Insulation Kit   | 819.95 Kit  |
| 16540★🚗 | 65-70 | Hardtop/Sedan | Complete Hushmat Insulation Kit   | 839.95 Kit  |
| 16541★🚗 | 58    | Hardtop/Sedan | Floor Only Hushmat Insulation Kit | 359.95 Kit  |
| 16542★🚗 | 59-60 | Hardtop/Sedan | Floor Only Hushmat Insulation Kit | 359.95 Kit  |
| 16543★🚗 | 59-60 | El Camino     | Floor Only Hushmat Insulation Kit | 259.95 Kit  |
| 16544★🚗 | 61-64 | Hardtop/Sedan | Floor Only Hushmat Insulation Kit | 319.95 Kit  |
| 16545★🚗 | 65-70 | Hardtop/Sedan | Floor Only Hushmat Insulation Kit | 319.95 Kit  |



For installing an option that never was, Ididit designed the perfect replacement for original 1955-1957 columns, but with the added comfort of five-way tilt adjustment. Each column comes in four finishes: paintable steel, chrome, and polished or brushed aluminum. Each column can be adapted to work with the original steering wheel using the #3575 adapter kit or any GM steering wheel made after 1969, as well as many aftermarket wheels with the use of an adapter. Each column comes with an Ididit aluminum dress-up kit, wiring adapter harness for four-way flashers, rag joint coupler, and Ididit's exclusive Tri-five mount.

We offer each column in either non-column shift for all floor shift cars as well as in column shift for automatics. Each column is the correct length for 500 boxes. If you have chosen to use a rack on your car, let us know and we can special order a tilt column for your specific application. Note: All of our column kits include rag joints and floor mounts, but these can be bought separately below.

**IDIDIT DOESN'T BUILD ANY COLUMNS FOR 3-SPEED ON THE COLUMN.**

## IDIDIT TILT COLUMNS FOR COLUMN SHIFT

| Part # | Year  | Part              | Price       |
|--------|-------|-------------------|-------------|
| 12882★ | 58    | Paintable Steel   | 779.95 Ea.  |
| 12886★ | 59-60 | Paintable Steel   | 779.95 Ea.  |
| 12890★ | 61-62 | Paintable Steel   | 779.95 Ea.  |
| 12894★ | 63-64 | Paintable Steel   | 886.95 Ea.  |
| 12898★ | 65-66 | Paintable Steel   | 779.95 Ea.  |
| 12883★ | 58    | Chrome            | 992.95 Ea.  |
| 12887★ | 59-60 | Chrome            | 992.95 Ea.  |
| 12891★ | 61-62 | Chrome            | 992.95 Ea.  |
| 12895★ | 63-64 | Chrome            | 1099.95 Ea. |
| 12899★ | 65-66 | Chrome            | 992.95 Ea.  |
| 12884★ | 58    | Brushed Aluminum  | 1417.95 Ea. |
| 12888★ | 59-60 | Brushed Aluminum  | 1417.95 Ea. |
| 12892★ | 61-62 | Brushed Aluminum  | 1417.95 Ea. |
| 12900★ | 65-66 | Brushed Aluminum  | 1417.95 Ea. |
| 12885★ | 58    | Polished Aluminum | 1417.95 Ea. |
| 12889★ | 59-60 | Polished Aluminum | 1417.95 Ea. |
| 12893★ | 61-62 | Polished Aluminum | 1417.95 Ea. |
| 12901★ | 65-66 | Polished Aluminum | 1417.95 Ea. |

★ = special order non-stocking item, please allow 4-6 weeks for delivery.  
🚗 = add \$80.95 handling per item

## Tilt Columns

### IDIDIT TILT COLUMNS FOR FLOOR SHIFT

| Part # | Year  | Part              | Price       |
|--------|-------|-------------------|-------------|
| 12902★ | 58    | Paintable Steel   | 482.95 Ea.  |
| 12906★ | 59-60 | Paintable Steel   | 482.95 Ea.  |
| 12910★ | 61-62 | Paintable Steel   | 482.95 Ea.  |
| 12914★ | 63-64 | Paintable Steel   | 581.95 Ea.  |
| 12918★ | 65-66 | Paintable Steel   | 482.95 Ea.  |
| 12903★ | 58    | Chrome            | 624.95 Ea.  |
| 12907★ | 59-60 | Chrome            | 624.95 Ea.  |
| 12911★ | 61-62 | Chrome            | 624.95 Ea.  |
| 12915★ | 63-64 | Chrome            | 723.95 Ea.  |
| 12919★ | 65-66 | Chrome            | 624.95 Ea.  |
| 12904★ | 58    | Brushed Aluminum  | 922.95 Ea.  |
| 12908★ | 59-60 | Brushed Aluminum  | 922.95 Ea.  |
| 12912★ | 61-62 | Brushed Aluminum  | 922.95 Ea.  |
| 12916★ | 63-64 | Brushed Aluminum  | 1014.95 Ea. |
| 12920★ | 65-66 | Brushed Aluminum  | 922.95 Ea.  |
| 12905★ | 58    | Polished Aluminum | 922.95 Ea.  |
| 12909★ | 59-60 | Polished Aluminum | 922.95 Ea.  |
| 12913★ | 61-62 | Polished Aluminum | 922.95 Ea.  |
| 12917★ | 63-64 | Polished Aluminum | 1014.95 Ea. |
| 12921★ | 65-66 | Polished Aluminum | 922.95 Ea.  |

### IDIDIT STEERING WHEEL ADAPTERS



| Part # | Part                                     | Price      |
|--------|--|------------|
| 4188★  | 9-Bolt Wheel Adapter w/o Horn            | 74.95 Ea.  |
| 4189★  | 9-Bolt Wheel Adapter w/Horn              | 88.95 Ea.  |
| 4190★  | 9-Bolt Shorty Wheel Adapter              | 144.95 Ea. |
| 4191★  | 5-Bolt Wheel Adapter                     | 88.95 Ea.  |
| 4192★  | 6-Bolt Wheel Adapter w/Lecarra Wheel     | 88.95 Ea.  |
| 4193★  | 6-Bolt Wheel Adapter w/Momo Wheel        | 88.95 Ea.  |
| 4194★  | 6-Bolt Wheel Adapter w/Dino/Diablo Wheel | 88.95 Ea.  |
| 4195★  | 6-Bolt Wheel Adapter w/Nardi Wheel       | 88.95 Ea.  |
| 4196★  | 3-Bolt Wheel Adapter                     | 88.95 Ea.  |
| 4197★  | 3-Bolt Bell Wheel Adapter                | 88.95 Ea.  |

### IDIDIT 58-66 COLUMN INSTALLATION KITS

| Part # | Year  | Part                               | Price      |
|--------|-------|------------------------------------|------------|
| 12922★ | 58    | Steer Gear w/3/4X30 Spline Shaft   | 299.95 Kit |
| 12923★ | 58    | Steer Gear w/3/4X36 Spline Shaft   | 299.95 Kit |
| 12924★ | 59-62 | Steer Gear w/3/4X30 Spline Shaft   | 299.95 Kit |
| 12925★ | 59-62 | Steer Gear w/3/4X36 Spline Shaft   | 299.95 Kit |
| 12926★ | 63-66 | Steer Gear w/3/4X30 Spline Shaft   | 299.95 Kit |
| 12927★ | 63-66 | Steer Gear w/3/4X36 Spline Shaft   | 299.95 Kit |
| 10762★ | 65-66 | Steer Gear w/13/16X36 Spline Shaft | 162.95 Kit |

### IDIDIT SHIFT INDICATOR KITS



3573



3718

| Part # | Year  | Model                             | Part                       | Price     |
|--------|-------|-----------------------------------|----------------------------|-----------|
| 3573   | 58-70 | w/Ididit Column w/Turbo Trans     | Shift Indicator Kit        | 29.95 Kit |
| 3574   | 58-70 | w/Ididit Column w/Overdrive Trans | Shift Indicator Kit        | 29.95 Kit |
| 3718   | 58-70 | w/Ididit Column w/Turbo Trans     | Chrome Shift Indicator Kit | 83.95 Kit |
| 3719   | 58-70 | w/Ididit Column w/Overdrive Trans | Chrome Shift Indicator Kit | 83.95 Kit |

# Interior



ACC was born in 1977, and we've been on an epic journey ever since. From our beginnings as an Auto Trim Business to becoming the world's largest manufacturer of Automotive Flooring products, we've tried to stay true to our core principles. Deliver exceptional products made in the USA. Strive every day to be better than the day before. Do it faster than anyone. We are very grateful to the millions of customers who trust us each year and for joining us on this awesome ride. We hope that you'll continue to be a part of our story.

### Why ACC?

Automotive Flooring is what we do. It's all we do. It's not a side business. It's not one of numerous other product lines that could divide our attention. It's all we focus on every day. We know you and your vehicle deserve that. Our dedicated team is our biggest asset. These long time employees insure the products we produce every day are of the highest quality and made with the best craftsmanship. From our engineers, to the materials and equipment we use, to our dedicated staff, we are relentless in our pursuit to manufacture a product that we all are proud of.

## CARPET

Complete cut and sewn set of 80/20 nylon loop on 1958 and 1963-1970. 1959-1962 is the salt and pepper nylon loop. Both styles come with correct binding and heel pad. Includes jute underlay and new dimmer switch grommet.

### 1958 CONVERTIBLE 80/20 WEAWE

These Products Are Not ACC Brand Carpet.  
They Are Manufactured By Trim Parts.

| Part # | Color | Price      |
|--------|-------|------------|
| 13405★ | Red   | 219.95 Set |
| 13406★ | Black | 219.95 Set |
| 13407★ | Blue  | 219.95 Set |
| 13409★ | Aqua  | 219.95 Set |
| 13410★ | Green | 219.95 Set |
| 13411★ | Gold  | 219.95 Set |

### 1958 2-DR SEDAN 80/20 WEAWE

| Part # | Color | Price      |
|--------|-------|------------|
| 13426★ | Blue  | 209.95 Set |
| 13428★ | Aqua  | 209.95 Set |
| 13429★ | Green | 209.95 Set |
| 13430★ | Gold  | 209.95 Set |
| 13431★ | Gray  | 209.95 Set |

### 1959 2-DR HARDTOP & CONVERTIBLE

| Part # | Color Combination       | Price      |
|--------|-------------------------|------------|
| 13444★ | Red Salt & Pepper       | 299.95 Set |
| 13445★ | Black 80/20 Weave       | 199.95 Set |
| 13446★ | Blue Salt & Pepper      | 299.95 Set |
| 13447★ | Turquoise Salt & Pepper | 299.95 Set |
| 16337★ | Black                   | 199.95 Set |
| 16338★ | Red                     | 199.95 Set |
| 16339★ | Blue                    | 199.95 Set |
| 16340★ | Aqua                    | 199.95 Set |

### 1958 2-DR HARDTOP 80/20 WEAWE

| Part # | Color | Price      |
|--------|-------|------------|
| 13412★ | Red   | 209.95 Set |
| 13413★ | Black | 209.95 Set |
| 13414★ | Blue  | 209.95 Set |
| 13416★ | Aqua  | 209.95 Set |
| 13417★ | Green | 209.95 Set |
| 13418★ | Gold  | 209.95 Set |
| 13419★ | Gray  | 209.95 Set |

### 1958 4-DR SEDAN 80/20 WEAWE

| Part # | Color | Price      |
|--------|-------|------------|
| 13432★ | Blue  | 209.95 Set |
| 13434★ | Aqua  | 209.95 Set |
| 13435★ | Green | 209.95 Set |
| 13436★ | Gold  | 209.95 Set |
| 13437★ | Gray  | 209.95 Set |

### 1959 2-DR SEDAN

| Part # | Color Combination       | Price      |
|--------|-------------------------|------------|
| 13457★ | Blue Salt & Pepper      | 299.95 Set |
| 13458★ | Turquoise Salt & Pepper | 299.95 Set |
| 16342★ | Black                   | 199.95 Set |
| 16343★ | Red                     | 199.95 Set |
| 16344★ | Blue                    | 199.95 Set |
| 16345★ | Aqua                    | 199.95 Set |
| 16346★ | Gray                    | 199.95 Set |

### 1958 4-DR HARDTOP 80/20 WEAWE

| Part # | Color | Price      |
|--------|-------|------------|
| 13420★ | Blue  | 209.95 Set |
| 13422★ | Aqua  | 209.95 Set |
| 13423★ | Green | 209.95 Set |
| 13424★ | Gold  | 209.95 Set |
| 13425★ | Gray  | 209.95 Set |

### 1958 NOMAD 80/20 WEAWE

| Part # | Color | Price      |
|--------|-------|------------|
| 13438★ | Blue  | 219.95 Set |
| 13440★ | Aqua  | 219.95 Set |
| 13441★ | Green | 219.95 Set |
| 13442★ | Gold  | 219.95 Set |
| 13443★ | Gray  | 219.95 Set |

### 1959 4-DR HARDTOP

| Part # | Color Combination       | Price      |
|--------|-------------------------|------------|
| 13451★ | Red Salt & Pepper       | 309.95 Set |
| 13452★ | Blue Salt & Pepper      | 309.95 Set |
| 13453★ | Turquoise Salt & Pepper | 309.95 Set |

★ = special order non-stocking item, please allow 4-6 weeks for delivery.

Interiors CANNOT be returned!

# Interior

## CARPET-CONTINUED

### 1959 4-DR SEDAN & WAGON

| Part # | Color Combination       | Price      |
|--------|-------------------------|------------|
| 13462★ | Red Salt & Pepper       | 309.95 Set |
| 13463★ | Blue Salt & Pepper      | 309.95 Set |
| 13464★ | Turquoise Salt & Pepper | 309.95 Set |
| 16347★ | Black                   | 199.95 Set |
| 16348★ | Red                     | 199.95 Set |
| 16349★ | Blue                    | 199.95 Set |
| 16350★ | Aqua                    | 199.95 Set |
| 16351★ | Gray                    | 199.95 Set |

### 1959 EL CAMINO

| Part # | Color Combination       | Price      |
|--------|-------------------------|------------|
| 13468★ | Red Salt & Pepper       | 299.95 Set |
| 13469★ | Black 80/20 Weave       | 199.95 Set |
| 13470★ | Blue Salt & Pepper      | 299.95 Set |
| 13471★ | Turquoise Salt & Pepper | 299.95 Set |
| 16352★ | Black                   | 199.95 Set |
| 16353★ | Red                     | 199.95 Set |
| 16354★ | Blue                    | 199.95 Set |
| 16355★ | Aqua                    | 199.95 Set |
| 16356★ | Gray                    | 199.95 Set |

### 1960 2-DR HARDTOP & CONVERTIBLE

| Part # | Color Combination       | Price      |
|--------|-------------------------|------------|
| 13475★ | Red Salt & Pepper       | 309.95 Set |
| 13476★ | Black 80/20 Weave       | 199.95 Set |
| 13477★ | Blue Salt & Pepper      | 309.95 Set |
| 13478★ | Turquoise Salt & Pepper | 309.95 Set |
| 16357★ | Black                   | 199.95 Set |
| 16358★ | Red                     | 199.95 Set |
| 16359★ | Blue                    | 199.95 Set |
| 16360★ | Aqua                    | 199.95 Set |
| 16361★ | Gray                    | 199.95 Set |

### 1960 4-DR SEDAN & WAGON

| Part # | Color Combination       | Price      |
|--------|-------------------------|------------|
| 13492★ | Red Salt & Pepper       | 299.95 Set |
| 13493★ | Blue Salt & Pepper      | 299.95 Set |
| 13494★ | Turquoise Salt & Pepper | 299.95 Set |
| 16367★ | Black                   | 219.95 Set |
| 16368★ | Red                     | 219.95 Set |
| 16369★ | Blue                    | 219.95 Set |
| 16370★ | Aqua                    | 219.95 Set |
| 16371★ | Gray                    | 219.95 Set |

### 1960 2-DR SEDAN

| Part # | Color Combination       | Price      |
|--------|-------------------------|------------|
| 13487★ | Blue Salt & Pepper      | 309.95 Set |
| 13488★ | Turquoise Salt & Pepper | 309.95 Set |
| 16362★ | Black                   | 209.95 Set |
| 16363★ | Red                     | 209.95 Set |
| 16364★ | Blue                    | 209.95 Set |
| 16365★ | Aqua                    | 209.95 Set |
| 16366★ | Gray                    | 209.95 Set |

### 1960 EL CAMINO

| Part # | Color Combination       | Price      |
|--------|-------------------------|------------|
| 13498★ | Red Salt & Pepper       | 299.95 Set |
| 13499★ | Black 80/20 Weave       | 179.95 Set |
| 13500★ | Blue Salt & Pepper      | 299.95 Set |
| 13501★ | Turquoise Salt & Pepper | 299.95 Set |
| 16372★ | Black                   | 219.95 Set |
| 16373★ | Red                     | 219.95 Set |
| 16374★ | Blue                    | 219.95 Set |
| 16375★ | Aqua                    | 219.95 Set |
| 16376★ | Gray                    | 219.95 Set |

### 1961-62 2-DR HARDTOP/ SEDAN/CONVERTIBLE

| Part # | Color Combination       | Price      |
|--------|-------------------------|------------|
| 13504★ | Red Salt & Pepper       | 289.95 Set |
| 13505★ | Black 80/20 Weave       | 179.95 Set |
| 13506★ | Blue Salt & Pepper      | 289.95 Set |
| 13507★ | Turquoise Salt & Pepper | 289.95 Set |
| 13511★ | Fawn Salt & Pepper      | 289.95 Set |

### 1961-62 4-DR SEDAN & WAGON

| Part # | Color Combination       | Price      |
|--------|-------------------------|------------|
| 13512★ | Red Salt & Pepper       | 289.95 Set |
| 13513★ | Blue Salt & Pepper      | 289.95 Set |
| 13514★ | Turquoise Salt & Pepper | 289.95 Set |
| 13517★ | Gray Salt & Pepper      | 289.95 Set |
| 13518★ | Fawn Salt & Pepper      | 289.95 Set |



★ = special order non-stocking item, please allow 4-6 weeks for delivery.

Interiors CANNOT be returned!

# Interior

## CARPET-CONTINUED

### 1963-64 4-DR HARDTOP/ SEDAN/WAGON 80/20 WEAVE

| Part # | Color       | Price      |
|--------|-------------|------------|
| 13528★ | Red         | 185.95 Set |
| 13529★ | Black       | 185.95 Set |
| 13530★ | Blue        | 185.95 Set |
| 13531★ | Dark Blue   | 185.95 Set |
| 13532★ | Aqua        | 185.95 Set |
| 13533★ | Green       | 185.95 Set |
| 13534★ | Dark Green  | 185.95 Set |
| 13535★ | Fawn        | 185.95 Set |
| 13536★ | Saddle      | 185.95 Set |
| 13537★ | Dark Saddle | 185.95 Set |
| 13538★ | Gray        | 185.95 Set |

### 1963-64 2-DR HARDTOP/ SEDAN/CONVERTIBLE 80/20 WEAVE

| Part # | Color       | Price      |
|--------|-------------|------------|
| 13519★ | Red         | 185.95 Set |
| 13505★ | Black       | 185.95 Set |
| 13520★ | Blue        | 185.95 Set |
| 13521★ | Aqua        | 185.95 Set |
| 13522★ | Green       | 185.95 Set |
| 13523★ | Dark Green  | 185.95 Set |
| 13524★ | Fawn        | 185.95 Set |
| 13525★ | Saddle      | 185.95 Set |
| 13526★ | Dark Saddle | 185.95 Set |
| 13527★ | Gray        | 185.95 Set |

### 1965-66 4-DR HARDTOP/ SEDAN 80/20 WEAVE

| Part # | Color       | Price      |
|--------|-------------|------------|
| 13550★ | Red         | 179.95 Set |
| 13551★ | Black       | 179.95 Set |
| 13552★ | Medium Blue | 179.95 Set |
| 13553★ | Aqua        | 179.95 Set |
| 13554★ | Green       | 179.95 Set |
| 13555★ | Dark Green  | 179.95 Set |
| 13556★ | Fawn        | 179.95 Set |
| 13557★ | Saddle      | 179.95 Set |

### 1965-70 2-DR HARDTOP/ SEDAN/CONVERTIBLE 80/20 WEAVE

| Part # | Color       | Price      |
|--------|-------------|------------|
| 13539★ | Red         | 179.95 Set |
| 13540★ | Maroon      | 179.95 Set |
| 13541★ | Black       | 179.95 Set |
| 13542★ | Medium Blue | 179.95 Set |
| 13543★ | Dark Blue   | 179.95 Set |
| 13544★ | Aqua        | 179.95 Set |
| 13545★ | Dark Green  | 179.95 Set |
| 13546★ | Gold        | 179.95 Set |
| 13547★ | Ivy Gold    | 179.95 Set |
| 13548★ | Fawn        | 179.95 Set |
| 13549★ | Saddle      | 179.95 Set |

### INTERIOR KITS LABOR CHARGES

The following is a list of charges that we offer on special interior demands:

| Procedure                                | Price             |
|--|-------------------|
| Cleaning 59-62 Upper Rails               | \$65.95 Per Pair  |
| Covering Rear Armrests 58-68 Hardtop     | \$325.95 Per Pair |
| Covering Rear Armrests 58-68 Convertible | \$325.95 Per Pair |
| Cleaning Rear Armrests                   | \$65.95 Ea.       |
| Covering Customer's Sunvisors            | \$99.95 Per Pair  |



All interiors are special order items. You need to allow four to six weeks for delivery. Interiors CANNOT be returned!

## 1958 TRIM COMBINATIONS

### 58 BEL-AIR 2/4-DR HARDTOP

| Trim # | Color Combination                            |
|--------|--|
| 805    | Silver Cloth/Gunmetal Silver Vinyl           |
| 814    | Medium Green Cloth/Light/Dark Green Vinyl    |
| 825    | Medium Blue Cloth/Light Medium Blue Vinyl    |
| 836    | Turquoise Cloth/Light/Medium Turquoise Vinyl |
| 846    | Gold Cloth/Beige/Gold Vinyl                  |
| 861    | Coral Cloth/Light/Medium Coral Vinyl         |

### 58 BEL-AIR 2/4-DR SEDAN & NOMAD WAGON

| Trim # | Color Combination                            |
|--------|--|
| 805    | Silver Cloth/Gunmetal Silver Vinyl           |
| 814    | Medium Green Cloth/Light/Dark Green Vinyl    |
| 825    | Medium Blue Cloth/Light Medium Blue Vinyl    |
| 836    | Turquoise Cloth/Light/Medium Turquoise Vinyl |
| 861    | Coral Cloth/Light/Medium Coral Vinyl         |

### 58 IMPALA 2-DR HARDTOP

| Trim # | Color Combination                            |
|--------|--|
| 806    | Black/Silver/Turquoise Cloth/Black Vinyl     |
| 815    | Green/Silver/Green Cloth/Green Vinyl         |
| 826    | Blue/Silver/Blue Cloth/Blue Vinyl            |
| 836    | Turquoise/Silver/Black Cloth/Turquoise Vinyl |
| 847    | Gold/Beige/Copper Cloth/Gold Vinyl           |
| 854    | Red/Silver/Black Cloth/Red Vinyl             |
| 861    | Coral/Coral/Coral Cloth/Coral Vinyl          |

### 58 IMPALA CONVERTIBLE

| Trim # | Color Combination                            |
|--------|--|
| 807    | Black/Silver/Turquoise Cloth/Black Vinyl     |
| 817    | Green/Silver/Green Cloth/Green Vinyl         |
| 827    | Blue/Silver/Blue Cloth/Blue Vinyl            |
| 837    | Turquoise/Silver/Black Cloth/Turquoise Vinyl |
| 848    | Gold/Beige/Copper Cloth/Gold Vinyl           |
| 855    | Red/Silver/Black Cloth/Red Vinyl             |
| 862    | Coral/Coral/Coral Cloth/Coral Vinyl          |

★ = special order non-stocking item, please allow 4-6 weeks for delivery.

All Interiors are special order items, please allow 4-6 weeks for delivery.

Interiors CANNOT be returned!

# Interior

## 1959 TRIM COMBINATIONS

| 59 IMPALA CONVERTIBLE |           |
|-----------------------|-----------|
| Trim #                | Color     |
| 810                   | Gray      |
| 826                   | Green     |
| 842                   | Blue      |
| 852                   | Turquoise |
| 866                   | Copper    |
| 874                   | Red       |

| 59 IMPALA 2/4-DR HARDTOP |           |
|--------------------------|-----------|
| Trim #                   | Color     |
| 809                      | Gray      |
| 825                      | Green     |
| 841                      | Blue      |
| 853                      | Turquoise |
| 865                      | Copper    |
| 873                      | Red       |

| 59 IMPALA 4-DR SEDAN/WAGON |           |
|----------------------------|-----------|
| Trim #                     | Color     |
| 809                        | Gray      |
| 825                        | Green     |
| 841                        | Blue      |
| 853                        | Turquoise |
| 865                        | Copper    |
| 873                        | Red       |

## 1960 TRIM COMBINATIONS

| 60 IMPALA CONVERTIBLE |                     |
|-----------------------|---------------------|
| Trim #                | Color Combination   |
| 810                   | Black/White         |
| 826                   | Green/Green         |
| 842                   | Blue/Blue           |
| 853                   | Turquoise/Turquoise |
| 866                   | Copper/Copper       |
| 874                   | Red/White           |

| 60 IMPALA 2/4-DR HARDTOP |           |
|--------------------------|-----------|
| Trim #                   | Color     |
| 809                      | Gray      |
| 825                      | Green     |
| 841                      | Blue      |
| 852                      | Turquoise |
| 865                      | Copper    |
| 873                      | Red       |

| 60 IMPALA 4-DR SEDAN/WAGON |           |
|----------------------------|-----------|
| Trim #                     | Color     |
| 809                        | Gray      |
| 825                        | Green     |
| 841                        | Blue      |
| 852                        | Turquoise |
| 865                        | Copper    |
| 873                        | Red       |

| 60 BEL-AIR 2-DR SEDAN |                     |
|-----------------------|---------------------|
| Trim #                | Color Combination   |
| 809                   | Gray/Gray           |
| 822                   | Green/Green         |
| 838                   | Blue/Blue           |
| 849                   | Turquoise/Turquoise |
| 862                   | Copper/Copper       |

## 1961 TRIM COMBINATIONS

| 61 IMPALA CONVERTIBLE |                   |
|-----------------------|-------------------|
| Trim #                | Color Combination |
| 810                   | Gray              |
| 826                   | Green             |
| 842                   | Blue              |
| 853                   | Turquoise         |
| 866                   | Fawn              |
| 874                   | Red               |

| 61 IMPALA 2/4-DR HARDTOP/SEDAN |           |
|--------------------------------|-----------|
| Trim #                         | Color     |
| 809                            | Gray      |
| 825                            | Green     |
| 841                            | Blue      |
| 852                            | Turquoise |
| 865                            | Fawn      |
| 873                            | Red       |

| 61 IMPALA 4-DR WAGON |           |
|----------------------|-----------|
| Trim #               | Color     |
| 809                  | Gray      |
| 825                  | Green     |
| 841                  | Blue      |
| 852                  | Turquoise |
| 865                  | Fawn      |
| 873                  | Red       |

| 61 BEL-AIR 2/4-DR HARDTOP/SEDAN |                   |
|---------------------------------|-------------------|
| Trim #                          | Color Combination |
| 807                             | Gray              |
| 823                             | Green             |
| 838                             | Blue              |
| 850                             | Turquoise         |
| 862                             | Fawn              |
| 873                             | Red               |

| 61 BEL-AIR 4-DR WAGON |                   |
|-----------------------|-------------------|
| Trim #                | Color Combination |
| 807                   | Gray              |
| 823                   | Green             |
| 838                   | Blue              |
| 850                   | Turquoise         |
| 862                   | Fawn              |
| 873                   | Red               |

All Interiors are special order items, please allow 4-6 weeks for delivery.

Interiors CANNOT be returned!

# Interior

## 1962 TRIM COMBINATIONS

### 62 IMPALA SS CONVERTIBLE

| Trim # | Color     |
|--------|-----------|
| 815    | Black     |
| 821    | Green     |
| 831    | Blue      |
| 845    | Turquoise |
| 856    | Fawn      |
| 879    | Red       |
| 890    | Gold      |

### 62 IMPALA 2/4-DR HARDTOP

| Trim # | Color     |
|--------|-----------|
| 814    | Black     |
| 826    | Green     |
| 842    | Blue      |
| 853    | Turquoise |
| 866    | Fawn      |
| 874    | Red       |
| 892    | Gold      |

### 62 BEL-AIR 4-DR SEDAN/ WAGON

| Trim # | Color     |
|--------|-----------|
| 823    | Green     |
| 839    | Blue      |
| 850    | Turquoise |
| 863    | Fawn      |
| 872    | Red       |

### 62 IMPALA CONVERTIBLE

| Trim # | Color     |
|--------|-----------|
| 814    | Black     |
| 829    | Green     |
| 836    | Blue      |
| 847    | Turquoise |
| 870    | Fawn      |
| 886    | Red       |
| 894    | Gold      |

### 62 IMPALA 4-DR SEDAN/ WAGON

| Trim # | Color     |
|--------|-----------|
| 814    | Black     |
| 826    | Green     |
| 842    | Blue      |
| 853    | Turquoise |
| 866    | Fawn      |
| 874    | Red       |
| 892    | Gold      |

### 62 IMPALA SS 2-DR HARDTOP

| Trim # | Color     |
|--------|-----------|
| 816    | Black     |
| 827    | Green     |
| 843    | Blue      |
| 854    | Turquoise |
| 857    | Fawn      |
| 875    | Red       |
| 891    | Gold      |

### 62 BEL-AIR 2-DR HARDTOP/ SEDAN

| Trim # | Color     |
|--------|-----------|
| 823    | Green     |
| 839    | Blue      |
| 850    | Turquoise |
| 863    | Fawn      |
| 872    | Red       |

## 1963 TRIM COMBINATIONS

### 63 IMPALA 2-DR HARDTOP

| Trim # | Color     |
|--------|-----------|
| 814    | Black     |
| 829    | Green     |
| 842    | Blue      |
| 847    | Turquoise |
| 859    | Fawn      |
| 857    | Saddle    |
| 886    | Red       |

### 63 IMPALA 4-DR SEDAN/ WAGON

| Trim # | Color     |
|--------|-----------|
| 811    | Black     |
| 826    | Green     |
| 842    | Blue      |
| 853    | Turquoise |
| 866    | Fawn      |
| 857    | Saddle    |
| 874    | Red       |

### 63 IMPALA SS CONVERTIBLE

| Trim # | Color     |
|--------|-----------|
| 815    | Black     |
| 821    | Green     |
| 831    | Blue      |
| 845    | Turquoise |
| 856    | Fawn      |
| 879    | Red       |
| 890    | Gold      |

### 63 IMPALA SS 2-DR HARDTOP

| Trim # | Color     |
|--------|-----------|
| 812    | Black     |
| 827    | Green     |
| 843    | Blue      |
| 854    | Turquoise |
| 858    | Fawn      |
| 867    | Saddle    |
| 875    | Red       |

### 63 IMPALA 2/4-DR HARDTOP

| Trim # | Color     |
|--------|-----------|
| 811    | Black     |
| 826    | Green     |
| 842    | Blue      |
| 853    | Turquoise |
| 866    | Fawn      |
| 857    | Saddle    |
| 874    | Red       |

### 63 BISCAYNE 2/4-DR SEDAN

| Trim # | Color     |
|--------|-----------|
| 852    | Turquoise |
| 863    | Fawn      |
| 876    | Red       |

All Interiors are special order items, please allow 4-6 weeks for delivery.

Interiors CANNOT be returned!

# Interior

## 1964 TRIM COMBINATIONS

### 64 IMPALA SS CONVERTIBLE/ HARDTOP

| Trim # | Color Combination |
|--------|-------------------|
| 805    | Silver            |
| 815    | Black             |
| 823    | Green             |
| 831    | Blue              |
| 845    | White/Turquoise   |
| 856    | Oyster            |
| 862    | Saddle            |
| 878    | White/Red         |
| 879    | Red               |

### 64 BEL-AIR 4-DR WAGON

| Trim # | Color Combination |
|--------|-------------------|
| 823    | Green             |
| 839    | Blue              |
| 850    | Turquoise         |
| 863    | Oyster            |
| 872    | Red               |

### 64 IMPALA CONVERTIBLE

| Trim # | Color Combination |
|--------|-------------------|
| 814    | Black             |
| 829    | Green             |
| 836    | Blue              |
| 847    | Turquoise         |
| 859    | Saddle            |
| 870    | Oyster            |
| 874    | Red               |

### 64 BEL-AIR 2/4-DR SEDAN

| Trim # | Color Combination |
|--------|-------------------|
| 823    | Green             |
| 839    | Blue              |
| 850    | Turquoise         |
| 863    | Oyster            |
| 872    | Red               |

### 64 BISCAYNE 2/4-DR SEDAN

| Trim # | Color Combination |
|--------|-------------------|
| 850    | Turquoise         |
| 863    | Oyster            |
| 872    | Red               |

### 64 IMPALA 2/4-DR HARDTOP

| Trim # | Color Combination |
|--------|-------------------|
| 811    | Black             |
| 826    | Green             |
| 842    | Blue              |
| 853    | Turquoise         |
| 857    | Saddle            |
| 866    | Oyster            |
| 886    | Red               |

### 64 IMPALA 4-DR SEDAN/ WAGON

| Trim # | Color Combination |
|--------|-------------------|
| 811    | Black             |
| 826    | Green             |
| 842    | Blue              |
| 853    | Turquoise         |
| 857    | Saddle            |
| 866    | Oyster            |
| 886    | Red               |

## 1965 TRIM COMBINATIONS

### 65 IMPALA SS CONVERTIBLE/ HARDTOP

| Trim # | Color Combination |
|--------|-------------------|
| 802    | White/Black       |
| 805    | Slate             |
| 815    | Black             |
| 831    | Blue              |
| 845    | White/Turquoise   |
| 856    | Fawn              |
| 862    | Saddle            |
| 879    | Red               |

### 65 BISCAYNE 2-DR SEDAN

| Trim # | Color Combination |
|--------|-------------------|
| 852    | Turquoise         |
| 860    | Fawn              |
| 876    | Red               |

### 65 IMPALA 2/4-DR HARDTOP

| Trim # | Color Combination |
|--------|-------------------|
| 811    | Black             |
| 826    | Green             |
| 842    | Blue              |
| 853    | Turquoise         |
| 857    | Saddle            |
| 866    | Fawn              |
| 874    | Red               |

### 65 IMPALA CONVERTIBLE

| Trim # | Color Combination |
|--------|-------------------|
| 814    | Black             |
| 829    | Green             |
| 836    | Blue              |
| 847    | Turquoise         |
| 859    | Saddle            |
| 870    | Fawn              |
| 886    | Red               |

### 65 IMPALA 4-DR SEDAN

| Trim # | Color Combination |
|--------|-------------------|
| 811    | Black             |
| 826    | Green             |
| 842    | Blue              |
| 853    | Turquoise         |
| 857    | Saddle            |
| 866    | Fawn              |
| 874    | Red               |

### 65 IMPALA 2-DR HARDTOP (ALL VINYL)

| Trim # | Color Combination |
|--------|-------------------|
| 814    | Black             |
| 829    | Green             |
| 836    | Blue              |
| 847    | Turquoise         |
| 859    | Saddle            |
| 870    | Fawn              |
| 886    | Red               |

All Interiors are special order items, please allow 4-6 weeks for delivery.

Interiors CANNOT be returned!

# Interior

## 1968 TRIM COMBINATIONS-CONTINUED

| 68 IMPALA 2-DR HARDTOP |                   |
|------------------------|-------------------|
| Trim #                 | Color Combination |
| 805                    | Black             |
| 820                    | Blue              |
| 833                    | Ivy Gold          |
| 842                    | Turquoise         |
| 853                    | Gray/Green        |

| 68 BISCAYNE 2-DR SEDAN |                   |
|------------------------|-------------------|
| Trim #                 | Color Combination |
| 805                    | Black             |
| 820                    | Medium Blue       |
| 833                    | Ivy Gold          |

## 1969 TRIM COMBINATIONS

| 69 IMPALA 2-DR HARDTOP |                   |
|------------------------|-------------------|
| Trim #                 | Color Combination |
| 806                    | Black             |
| 820                    | Medium Blue       |
| 837                    | Gold              |
| 844                    | Turquoise         |
| 852                    | Ivy Green         |
| 860                    | Dark Green        |

| 69 IMPALA 2-DR HARDTOP (ALL VINYL) |                   |
|------------------------------------|-------------------|
| Trim #                             | Color Combination |
| <b>With Bucket Seats</b>           |                   |
| 812                                | Black             |
| 824                                | Dark Blue         |
| 854                                | Ivy Green         |
| 857                                | Red               |
| 859                                | Parchment         |
| <b>With Bench Seat</b>             |                   |
| 585                                | Parchment         |
| 806                                | Black             |
| 821                                | Dark Blue         |
| 853                                | Ivy Green         |
| 866                                | Red               |

| 69 IMPALA CONVERTIBLE    |                   |
|--------------------------|-------------------|
| Trim #                   | Color Combination |
| <b>With Bucket Seats</b> |                   |
| 812                      | Black             |
| 824                      | Dark Blue         |
| 854                      | Ivy Green         |
| 857                      | Red               |
| 859                      | Parchment         |
| <b>With Bench Seat</b>   |                   |
| 585                      | Parchment         |
| 806                      | Black             |
| 821                      | Dark Blue         |
| 853                      | Ivy Green         |
| 866                      | Red               |

## 1970 TRIM COMBINATIONS

| 70 IMPALA CONVERTIBLE |                   |
|-----------------------|-------------------|
| Trim #                | Color Combination |
| 806                   | Black             |
| 821                   | Medium Blue       |
| 828                   | Sandalwood        |
| 830                   | Light Saddle      |
| 861                   | Dark Green        |
| 866                   | Red               |

| 70 IMPALA 2-DR HARDTOP |                   |
|------------------------|-------------------|
| Trim #                 | Color Combination |
| 806                    | Black             |
| 821                    | Medium Blue       |
| 828                    | Sandalwood        |
| 830                    | Light Saddle      |
| 861                    | Dark Green        |
| 866                    | Red               |

| 70 IMPALA 2-DR HARDTOP (CLOTH/VINYL) |                   |
|--------------------------------------|-------------------|
| Trim #                               | Color Combination |
| 805                                  | Black             |
| 820                                  | Medium Blue       |
| 837                                  | Gold              |
| 844                                  | Turquoise         |
| 860                                  | Dark Green        |

## 1958 SEAT COVERS

Presewn seat covers using correct grain vinyls and cloths. Set includes covers for and front and rear seats with all listings attached.

| 58 BEL-AIR 2-DR SEDAN |                   |            |
|-----------------------|-------------------|------------|
| Part #                | Color Combination | Price      |
| 13584★                | Silver            | 829.95 Set |
| 13585★                | Green             | 829.95 Set |
| 13586★                | Blue              | 829.95 Set |
| 13587★                | Turquoise         | 829.95 Set |
| 13588★                | Gold              | 829.95 Set |
| 13589★                | Coral             | 829.95 Set |

| 58 BEL-AIR 2-DR HARDTOP |                   |            |
|-------------------------|-------------------|------------|
| Part #                  | Color Combination | Price      |
| 13572★                  | Silver            | 829.95 Set |
| 13573★                  | Green             | 829.95 Set |
| 13574★                  | Blue              | 829.95 Set |
| 13575★                  | Turquoise         | 829.95 Set |
| 13576★                  | Gold              | 829.95 Set |
| 13577★                  | Coral             | 829.95 Set |

| 58 IMPALA CONVERTIBLE |                        |            |
|-----------------------|------------------------|------------|
| Part #                | Color Combination      | Price      |
| 13558★                | Black/Sliver/Turquoise | 829.95 Set |
| 13559★                | Green/Sliver/Green     | 829.95 Set |
| 13560★                | Blue/Silver/Blue       | 829.95 Set |
| 13561★                | Turquoise/Sliver/Black | 829.95 Set |
| 13562★                | Gold/Beige/Copper      | 829.95 Set |
| 13563★                | Red/Silver/Black       | 829.95 Set |
| 13564★                | Coral/Coral/Coral      | 829.95 Set |

★ = special order non-stocking item, please allow 4-6 weeks for delivery.

Interiors CANNOT be returned!

# Interior

## 1966 TRIM COMBINATIONS

### 66 IMPALA SS CONVERTIBLE/ HARDTOP

| Trim # | Color Combination |
|--------|-------------------|
| 813    | Black             |
| 844    | Bright Blue       |
| 846    | Turquoise         |
| 869    | Fawn              |
| 872    | Light Blue        |
| 873    | Red               |
| 885    | White             |

### 66 IMPALA CONVERTIBLE (CLOTH/VINYL)

| Trim # | Color Combination |
|--------|-------------------|
| 811    | Black             |
| 826    | Green             |
| 842    | Blue              |
| 853    | Turquoise         |
| 866    | Fawn              |
| 874    | Red               |

### 66 IMPALA 2-DR HARDTOP (CLOTH/VINYL)

| Trim # | Color Combination |
|--------|-------------------|
| 811    | Black             |
| 826    | Green             |
| 842    | Blue              |
| 853    | Turquoise         |
| 866    | Fawn              |
| 874    | Red               |

### 66 IMPALA CONVERTIBLE (VINYL)

| Trim # | Color Combination |
|--------|-------------------|
| 814    | Black             |
| 836    | Light Blue        |
| 844    | Bright Blue       |
| 853    | Turquoise         |
| 870    | Fawn              |
| 871    | Red               |

### 66 IMPALA 2-DR HARDTOP (VINYL)

| Trim # | Color Combination |
|--------|-------------------|
| 814    | Black             |
| 836    | Light Blue        |
| 844    | Bright Blue       |
| 853    | Turquoise         |
| 870    | Fawn              |
| 871    | Red               |

## 1967 TRIM COMBINATIONS

### 67 IMPALA SS 2-DR HARDTOP

| Trim # | Color Combination     |
|--------|-----------------------|
| 810    | Black                 |
| 844    | Bright Blue           |
| 870    | Red                   |
| 885    | Gold                  |
| 895    | Parchment (Off White) |

### 67 IMPALA SS CONVERTIBLE

| Trim # | Color Combination     |
|--------|-----------------------|
| 813    | Black                 |
| 848    | Bright Blue           |
| 873    | Red                   |
| 890    | Gold                  |
| 898    | Parchment (Off White) |

### 67 IMPALA SS CONVERTIBLE

| Trim # | Color Combination     |
|--------|-----------------------|
| 813    | Black                 |
| 848    | Bright Blue           |
| 873    | Red                   |
| 890    | Gold                  |
| 898    | Parchment (Off White) |

### 67 IMPALA 2-DR HARDTOP

| Trim # | Color Combination |
|--------|-------------------|
| 811    | Black             |
| 842    | Blue              |
| 853    | Turquoise         |
| 874    | Maroon            |
| 888    | Gold              |

### 67 IMPALA CONVERTIBLE

| Trim # | Color Combination     |
|--------|-----------------------|
| 814    | Black                 |
| 836    | Light Blue            |
| 845    | Bright Blue           |
| 871    | Red                   |
| 889    | Gold                  |
| 894    | Parchment (Off White) |

### 67 IMPALA 2-DR HARDTOP (ALL VINYL)

| Trim # | Color Combination     |
|--------|-----------------------|
| 814    | Black                 |
| 836    | Light Blue            |
| 845    | Bright Blue           |
| 871    | Red                   |
| 889    | Gold                  |
| 894    | Parchment (Off White) |

## 1968 TRIM COMBINATIONS

### 68 IMPALA CONVERTIBLE

| Trim # | Color Combination     |
|--------|-----------------------|
| 813    | Black                 |
| 821    | Medium Blue           |
| 841    | Ivy Gold              |
| 858    | Parchment (Off White) |
| 864    | Teal Blue             |
| 866    | Red                   |

### 68 IMPALA 2-DR HARDTOP (ALL VINYL)

| Trim # | Color Combination     |
|--------|-----------------------|
| 813    | Black                 |
| 821    | Medium Blue           |
| 841    | Ivy Gold              |
| 858    | Parchment (Off White) |
| 864    | Teal Blue             |
| 866    | Red                   |

### 68 IMPALA SS CONVERTIBLE / 2-DR HARDTOP

| Trim # | Color Combination     |
|--------|-----------------------|
| 812    | Black                 |
| 836    | Ivy Gold              |
| 859    | Parchment (Off White) |
| 862    | Teal Blue             |
| 868    | Red                   |

All Interiors are special order items, please allow 4-6 weeks for delivery.

Interiors CANNOT be returned!

# Interior

## 1958 SEAT COVERS-CONTINUED

Presewn seat covers using correct grain vinyls and cloths. Set includes covers for the front and rear seats with all listings attached.

### 58 IMPALA 2-DR HARDTOP

| Part # | Color Combination      | Price      |
|--------|------------------------|------------|
| 13565★ | Black/Sliver/Turquoise | 719.95 Set |
| 13566★ | Green/Sliver/Green     | 719.95 Set |
| 13567★ | Blue/Silver/Blue       | 719.95 Set |
| 13568★ | Turquoise/Sliver/Black | 719.95 Set |
| 13569★ | Gold/Beige/Copper      | 719.95 Set |
| 13570★ | Red/Silver/Black       | 719.95 Set |
| 13571★ | Coral/Coral/Coral      | 719.95 Set |

### 58 BEL-AIR 4-DR HARDTOP

| Part # | Color Combination | Price      |
|--------|-------------------|------------|
| 13578★ | Silver            | 829.95 Set |
| 13579★ | Green             | 829.95 Set |
| 13580★ | Blue              | 829.95 Set |
| 13581★ | Turquoise         | 829.95 Set |
| 13582★ | Gold              | 829.95 Set |
| 13583★ | Coral             | 829.95 Set |

### 58 BEL-AIR 4-DR SEDAN

| Part # | Color Combination | Price      |
|--------|-------------------|------------|
| 13590★ | Silver            | 829.95 Set |
| 13591★ | Green             | 829.95 Set |
| 13592★ | Blue              | 829.95 Set |
| 13593★ | Turquoise         | 829.95 Set |
| 13594★ | Gold              | 829.95 Set |
| 13595★ | Coral             | 829.95 Set |

### 58 BISCAYNE 2-DR SEDAN

| Part # | Color Combination | Price      |
|--------|-------------------|------------|
| 16377★ | Blue              | 829.95 Set |
| 16378★ | Gold/Silver       | 829.95 Set |
| 16379★ | Green             | 829.95 Set |
| 16380★ | Gray/Silver       | 829.95 Set |
| 16381★ | Turquoise         | 829.95 Set |

### 58 BISCAYNE 4-DR SEDAN

| Part # | Color Combination | Price      |
|--------|-------------------|------------|
| 16382★ | Blue              | 829.95 Set |
| 16383★ | Gold/Silver       | 829.95 Set |
| 16384★ | Green             | 829.95 Set |
| 16385★ | Gray/Silver       | 829.95 Set |
| 16386★ | Turquoise         | 829.95 Set |

### 58 NOMAD 4-DR WAGON

| Part # | Color Combination | Price      |
|--------|-------------------|------------|
| 13596★ | Silver            | 829.95 Set |
| 13597★ | Green             | 829.95 Set |
| 13598★ | Blue              | 829.95 Set |
| 13599★ | Turquoise         | 829.95 Set |
| 13600★ | Gold              | 829.95 Set |
| 13601★ | Coral             | 829.95 Set |

## 1959 SEAT COVERS

Presewn seat covers using correct grain vinyls and cloths. Set includes covers for the front and rear seats with all listings attached.

### 59 BROOKWOOD 2-DR WAGON

| Part # | Color Combination | Price      |
|--------|-------------------|------------|
| 16387★ | Blue/Blue         | 769.95 Set |
| 16388★ | Gray/Gray         | 769.95 Set |
| 16389★ | Green/Green       | 769.95 Set |

### 59 IMPALA CONVERTIBLE

| Part # | Color Combination | Price      |
|--------|-------------------|------------|
| 13602★ | Red               | 769.95 Set |
| 13603★ | Blue              | 769.95 Set |
| 13604★ | Turquoise         | 769.95 Set |
| 13605★ | Green             | 769.95 Set |
| 13606★ | Gray              | 769.95 Set |
| 13607★ | Copper            | 769.95 Set |

### 59 IMPALA 2-DR HARDTOP

| Part # | Color Combination | Price      |
|--------|-------------------|------------|
| 13608★ | Red               | 769.95 Set |
| 13609★ | Blue              | 769.95 Set |
| 13610★ | Turquoise         | 769.95 Set |
| 13611★ | Green             | 769.95 Set |
| 13612★ | Gray              | 769.95 Set |
| 13613★ | Copper            | 769.95 Set |

### 59 IMPALA 4-DR WAGON (6-PASS)

| Part # | Color Combination | Price      |
|--------|-------------------|------------|
| 13626★ | Red               | 769.95 Set |
| 13627★ | Blue              | 769.95 Set |
| 13628★ | Turquoise         | 769.95 Set |
| 13629★ | Green             | 769.95 Set |
| 13630★ | Gray              | 769.95 Set |
| 13631★ | Copper            | 769.95 Set |

### 59 IMPALA 4-DR HARDTOP

| Part # | Color Combination | Price      |
|--------|-------------------|------------|
| 13614★ | Gray              | 769.95 Set |
| 13615★ | Green             | 769.95 Set |
| 13616★ | Blue              | 769.95 Set |
| 13617★ | Copper            | 769.95 Set |
| 13618★ | Turquoise         | 769.95 Set |
| 13619★ | Red               | 769.95 Set |

### 59 IMPALA 4-DR SEDAN

| Part # | Color Combination | Price      |
|--------|-------------------|------------|
| 13620★ | Gray              | 769.95 Set |
| 13621★ | Green             | 769.95 Set |
| 13622★ | Blue              | 769.95 Set |
| 13623★ | Copper            | 769.95 Set |
| 13624★ | Turquoise         | 769.95 Set |
| 13625★ | Red               | 769.95 Set |

### 59 EL CAMINO

| Part # | Color Combination | Price      |
|--------|-------------------|------------|
| 13632★ | Red               | 529.95 Set |
| 13633★ | Blue              | 529.95 Set |
| 13634★ | Turquoise         | 529.95 Set |
| 13635★ | Green             | 529.95 Set |
| 13636★ | Gray              | 529.95 Set |
| 13637★ | Copper            | 529.95 Set |

### 59 IMPALA 4-DR WAGON (9-PASS)

| Part # | Color Combination | Price      |
|--------|-------------------|------------|
| 16390★ | Blue              | 969.95 Set |
| 16391★ | Copper            | 969.95 Set |
| 16392★ | Green             | 969.95 Set |

★ = special order non-stocking item, please allow 4-6 weeks for delivery.

Interiors CANNOT be returned!

# Interior

## 1960 SEAT COVERS

Presewn seat covers using correct grain vinyls and cloths. Set includes covers for the front and rear seats with all listings attached.

| 60 IMPALA 2-DR HARDTOP |                   |            |
|------------------------|-------------------|------------|
| Part #                 | Color Combination | Price      |
| 13644★                 | Red               | 769.95 Set |
| 13645★                 | Black             | 769.95 Set |
| 13646★                 | Turquoise         | 769.95 Set |
| 13647★                 | Blue              | 769.95 Set |
| 13648★                 | Green             | 769.95 Set |
| 13649★                 | Copper            | 769.95 Set |

| 60 IMPALA CONVERTIBLE |                   |            |
|-----------------------|-------------------|------------|
| Part #                | Color Combination | Price      |
| 13638★                | Red               | 809.95 Set |
| 13639★                | Black             | 809.95 Set |
| 13640★                | Turquoise         | 809.95 Set |
| 13641★                | Blue              | 809.95 Set |
| 13642★                | Green             | 809.95 Set |
| 13643★                | Copper            | 809.95 Set |

| 60 BEL-AIR 2-DR HARDTOP |                     |            |
|-------------------------|---------------------|------------|
| Part #                  | Color Combination   | Price      |
| 15390★                  | Gray/White          | 829.95 Set |
| 15391★                  | Green/Green         | 829.95 Set |
| 15392★                  | Blue/Blue           | 829.95 Set |
| 15393★                  | Copper/Copper       | 829.95 Set |
| 15394★                  | Turquoise/Turquoise | 829.95 Set |

| 60 IMPALA 4-DR HARDTOP |                   |            |
|------------------------|-------------------|------------|
| Part #                 | Color Combination | Price      |
| 13650★                 | Black             | 769.95 Set |
| 13651★                 | Green             | 769.95 Set |
| 13652★                 | Blue              | 769.95 Set |
| 13653★                 | Copper            | 769.95 Set |
| 13654★                 | Turquoise         | 769.95 Set |
| 13655★                 | Red               | 769.95 Set |

| 60 IMPALA 4-DR WAGON |                   |            |
|----------------------|-------------------|------------|
| Part #               | Color Combination | Price      |
| 13662★               | Red               | 769.95 Set |
| 13663★               | Black             | 769.95 Set |
| 13664★               | Turquoise         | 769.95 Set |
| 13665★               | Blue              | 769.95 Set |
| 13666★               | Green             | 769.95 Set |
| 13667★               | Copper            | 769.95 Set |

| 60 BEL-AIR 4-DR SEDAN |                   |            |
|-----------------------|-------------------|------------|
| Part #                | Color Combination | Price      |
| 16393★                | Gray              | 829.95 Set |
| 16394★                | Green             | 829.95 Set |
| 16395★                | Blue              | 829.95 Set |
| 16396★                | Copper            | 829.95 Set |
| 16397★                | Turquoise         | 829.95 Set |

| 60 BROOKWOOD 2-DR WAGON |                   |            |
|-------------------------|-------------------|------------|
| Part #                  | Color Combination | Price      |
| 16398★                  | Blue/Blue         | 829.95 Set |
| 16399★                  | Gray              | 829.95 Set |
| 16400★                  | Green/Green       | 829.95 Set |

| 60 IMPALA 4-DR SEDAN |                   |            |
|----------------------|-------------------|------------|
| Part #               | Color Combination | Price      |
| 13656★               | Black             | 769.95 Set |
| 13657★               | Green             | 769.95 Set |
| 13658★               | Blue              | 769.95 Set |
| 13659★               | Copper            | 769.95 Set |
| 13660★               | Turquoise         | 769.95 Set |
| 13661★               | Red               | 769.95 Set |

| 60 BEL-AIR 2-DR SEDAN |                   |            |
|-----------------------|-------------------|------------|
| Part #                | Color Combination | Price      |
| 13668★                | Gray              | 829.95 Set |
| 13669★                | Green             | 829.95 Set |
| 13670★                | Blue              | 829.95 Set |
| 13671★                | Copper            | 829.95 Set |
| 13672★                | Turquoise         | 829.95 Set |

| 60 EL CAMINO |                   |            |
|--------------|-------------------|------------|
| Part #       | Color Combination | Price      |
| 13673★       | Red               | 529.95 Set |
| 13674★       | Turquoise         | 529.95 Set |
| 13675★       | Black             | 529.95 Set |
| 13676★       | Blue              | 529.95 Set |
| 13677★       | Green             | 529.95 Set |
| 13678★       | Copper            | 529.95 Set |

## 1961 SEAT COVERS

Presewn seat covers using correct grain vinyls and cloths. Set includes covers for the front and rear seats with all listings attached.

| 61 IMPALA 2-DR HARDTOP |                   |            |
|------------------------|-------------------|------------|
| Part #                 | Color Combination | Price      |
| 13685★                 | Red               | 769.95 Set |
| 13686★                 | Fawn              | 769.95 Set |
| 13687★                 | Blue              | 769.95 Set |
| 13688★                 | Green             | 769.95 Set |
| 13689★                 | Turquoise         | 769.95 Set |
| 13690★                 | Gray              | 769.95 Set |



| 61 IMPALA CONVERTIBLE |                   |            |
|-----------------------|-------------------|------------|
| Part #                | Color Combination | Price      |
| 13679★                | Red               | 839.95 Set |
| 13680★                | Fawn              | 839.95 Set |
| 13681★                | Blue              | 839.95 Set |
| 13682★                | Green             | 839.95 Set |
| 13683★                | Gray              | 839.95 Set |
| 13684★                | Turquoise         | 839.95 Set |

★ = special order non-stocking item, please allow 4-6 weeks for delivery.

Interiors CANNOT be returned!

# Interior

## 1961 SEAT COVERS-CONTINUED

Presewn seat covers using correct grain vinyls and cloths. Set includes covers for the front and rear seats with all listings attached.

| <b>61 IMPALA 4-DR HARDTOP</b> |                   |            |
|-------------------------------|-------------------|------------|
| Part #                        | Color Combination | Price      |
| 13691★                        | Gray              | 769.95 Set |
| 13692★                        | Red               | 769.95 Set |
| 13693★                        | Green             | 769.95 Set |
| 13694★                        | Blue              | 769.95 Set |
| 13695★                        | Fawn              | 769.95 Set |
| 13696★                        | Turquoise         | 769.95 Set |

| <b>61 IMPALA 4-DR WAGON (6-PASS)</b> |                   |            |
|--------------------------------------|-------------------|------------|
| Part #                               | Color Combination | Price      |
| 13709★                               | Gray              | 769.95 Set |
| 13710★                               | Red               | 769.95 Set |
| 13711★                               | Green             | 769.95 Set |
| 13712★                               | Blue              | 769.95 Set |
| 13713★                               | Fawn              | 769.95 Set |
| 13714★                               | Turquoise         | 769.95 Set |

| <b>61 BEL-AIR 4-DR HARDTOP</b> |                   |            |
|--------------------------------|-------------------|------------|
| Part #                         | Color Combination | Price      |
| 13727★                         | Gray              | 829.95 Set |
| 13728★                         | Green             | 829.95 Set |
| 13729★                         | Blue              | 829.95 Set |
| 13730★                         | Red               | 829.95 Set |
| 13731★                         | Fawn              | 829.95 Set |
| 13732★                         | Turquoise         | 829.95 Set |

| <b>BISCAYNE 2-DR SEDAN</b> |                   |            |
|----------------------------|-------------------|------------|
| Part #                     | Color Combination | Price      |
| 16401★                     | Green             | 829.95 Set |
| 1961★                      | Gray/White        | 829.95 Set |
| 16403★                     | Blue              | 829.95 Set |

| <b>61 BEL-AIR 4-DR WAGON (9-PASS)</b> |                   |            |
|---------------------------------------|-------------------|------------|
| Part #                                | Color Combination | Price      |
| 13749★                                | Gray              | 999.95 Set |
| 13750★                                | Green             | 999.95 Set |
| 13751★                                | Blue              | 999.95 Set |
| 13752★                                | Turquoise         | 999.95 Set |
| 13753★                                | Fawn              | 999.95 Set |
| 13754★                                | Red               | 999.95 Set |

| <b>61 IMPALA 2-DR SEDAN</b> |                   |            |
|-----------------------------|-------------------|------------|
| Part #                      | Color Combination | Price      |
| 13697★                      | Gray              | 769.95 Set |
| 13698★                      | Red               | 769.95 Set |
| 13699★                      | Green             | 769.95 Set |
| 13700★                      | Blue              | 769.95 Set |
| 13701★                      | Fawn              | 769.95 Set |
| 13702★                      | Turquoise         | 769.95 Set |

| <b>61 IMPALA 4-DR WAGON (9-PASS)</b> |                   |            |
|--------------------------------------|-------------------|------------|
| Part #                               | Color Combination | Price      |
| 13715★                               | Gray              | 999.95 Set |
| 13716★                               | Red               | 999.95 Set |
| 13717★                               | Green             | 999.95 Set |
| 13718★                               | Blue              | 999.95 Set |
| 13719★                               | Fawn              | 999.95 Set |
| 13720★                               | Turquoise         | 999.95 Set |

| <b>61 BEL-AIR 4-DR SEDAN</b> |                   |            |
|------------------------------|-------------------|------------|
| Part #                       | Color Combination | Price      |
| 13738★                       | Gray              | 829.95 Set |
| 13739★                       | Green             | 829.95 Set |
| 13740★                       | Blue              | 829.95 Set |
| 13741★                       | Turquoise         | 829.95 Set |
| 13742★                       | Fawn              | 829.95 Set |

| <b>61 BEL-AIR 2-DR SEDAN</b> |                   |            |
|------------------------------|-------------------|------------|
| Part #                       | Color Combination | Price      |
| 13733★                       | Gray              | 829.95 Set |
| 13734★                       | Green             | 829.95 Set |
| 13735★                       | Blue              | 829.95 Set |
| 13736★                       | Turquoise         | 829.95 Set |
| 13737★                       | Fawn              | 829.95 Set |

| <b>61 IMPALA 4-DR SEDAN</b> |                   |            |
|-----------------------------|-------------------|------------|
| Part #                      | Color Combination | Price      |
| 13703★                      | Gray              | 769.95 Set |
| 13704★                      | Red               | 769.95 Set |
| 13705★                      | Green             | 769.95 Set |
| 13706★                      | Blue              | 769.95 Set |
| 13707★                      | Fawn              | 769.95 Set |
| 13708★                      | Turquoise         | 769.95 Set |

| <b>61 BEL-AIR 2-DR HARDTOP</b> |                   |            |
|--------------------------------|-------------------|------------|
| Part #                         | Color Combination | Price      |
| 13721★                         | Gray              | 829.95 Set |
| 13722★                         | Green             | 829.95 Set |
| 13723★                         | Blue              | 829.95 Set |
| 13724★                         | Red               | 829.95 Set |
| 13725★                         | Fawn              | 829.95 Set |
| 13726★                         | Turquoise         | 829.95 Set |

| <b>61 BEL-AIR 4-DR WAGON (6-PASS)</b> |                   |            |
|---------------------------------------|-------------------|------------|
| Part #                                | Color Combination | Price      |
| 13743★                                | Gray              | 829.95 Set |
| 13744★                                | Green             | 829.95 Set |
| 13745★                                | Blue              | 829.95 Set |
| 13746★                                | Turquoise         | 829.95 Set |
| 13747★                                | Fawn              | 829.95 Set |
| 13748★                                | Red               | 829.95 Set |



★ = special order non-stocking item, please allow 4-6 weeks for delivery.

Interiors CANNOT be returned!

# Interior

## 1962 SEAT COVERS

Presewn seat covers using correct grain vinyls and cloths. Set includes covers for the front and rear seats with all listings attached.

### 62 IMPALA SS CONVERTIBLE

| Part # | Color Combination | Price      |
|--------|-------------------|------------|
| 13755★ | Fawn              | 829.95 Set |
| 13756★ | Blue              | 829.95 Set |
| 13757★ | Turquoise         | 829.95 Set |
| 13758★ | Green             | 829.95 Set |
| 13759★ | Gold              | 829.95 Set |
| 13760★ | Red               | 829.95 Set |
| 13761★ | Black             | 829.95 Set |



### 62 IMPALA CONVERTIBLE

| Part # | Color Combination | Price      |
|--------|-------------------|------------|
| 13762★ | Fawn              | 829.95 Set |
| 13763★ | Blue              | 829.95 Set |
| 13764★ | Turquoise         | 829.95 Set |
| 13765★ | Green             | 829.95 Set |
| 13766★ | Gold              | 829.95 Set |
| 13767★ | Red               | 829.95 Set |
| 13768★ | Black             | 829.95 Set |

### 62 IMPALA SS 2-DR HARDTOP

| Part # | Color Combination | Price      |
|--------|-------------------|------------|
| 13769★ | Fawn              | 829.95 Set |
| 13770★ | Blue              | 829.95 Set |
| 13771★ | Turquoise         | 829.95 Set |
| 13772★ | Green             | 829.95 Set |
| 13773★ | Gold              | 829.95 Set |
| 13774★ | Red               | 829.95 Set |
| 13775★ | Black             | 829.95 Set |

### 62 IMPALA 4-DR HARDTOP

| Part # | Color Combination | Price      |
|--------|-------------------|------------|
| 13782★ | Fawn              | 769.95 Set |
| 13783★ | Blue              | 769.95 Set |
| 13784★ | Turquoise         | 769.95 Set |
| 13785★ | Green             | 769.95 Set |
| 13786★ | Gold              | 769.95 Set |
| 13787★ | Red               | 769.95 Set |

### 62 IMPALA 2-DR HARDTOP

| Part # | Color Combination | Price      |
|--------|-------------------|------------|
| 13776★ | Fawn              | 799.95 Set |
| 13777★ | Blue              | 799.95 Set |
| 13778★ | Turquoise         | 799.95 Set |
| 13779★ | Green             | 799.95 Set |
| 13780★ | Gold              | 799.95 Set |
| 13781★ | Red               | 799.95 Set |

### 62 BEL-AIR 2-DR HARDTOP

| Part # | Color Combination | Price      |
|--------|-------------------|------------|
| 13806★ | Red               | 829.95 Set |
| 13807★ | Blue              | 829.95 Set |
| 13808★ | Turquoise         | 829.95 Set |
| 13809★ | Green             | 829.95 Set |
| 13810★ | Fawn              | 829.95 Set |

### 62 IMPALA 4-DR SEDAN

| Part # | Color Combination | Price      |
|--------|-------------------|------------|
| 13788★ | Fawn              | 769.95 Set |
| 13789★ | Blue              | 769.95 Set |
| 13790★ | Turquoise         | 769.95 Set |
| 13791★ | Green             | 769.95 Set |
| 13792★ | Gold              | 769.95 Set |
| 13793★ | Red               | 769.95 Set |

### 62 IMPALA 4-DR WAGON (6-PASS)

| Part # | Color Combination | Price      |
|--------|-------------------|------------|
| 13794★ | Fawn              | 769.95 Set |
| 13795★ | Blue              | 769.95 Set |
| 13796★ | Turquoise         | 769.95 Set |
| 13797★ | Green             | 769.95 Set |
| 13798★ | Gold              | 769.95 Set |
| 13799★ | Red               | 769.95 Set |

### 62 IMPALA 4-DR WAGON (9-PASS)

| Part # | Color Combination | Price      |
|--------|-------------------|------------|
| 13800★ | Fawn              | 999.95 Set |
| 13801★ | Blue              | 999.95 Set |
| 13802★ | Turquoise         | 999.95 Set |
| 13803★ | Green             | 999.95 Set |
| 13804★ | Gold              | 999.95 Set |
| 13805★ | Red               | 999.95 Set |

### 62 BEL-AIR 4-DR SEDAN

| Part # | Color Combination | Price      |
|--------|-------------------|------------|
| 13816★ | Red               | 829.95 Set |
| 13817★ | Blue              | 829.95 Set |
| 13818★ | Turquoise         | 829.95 Set |
| 13819★ | Green             | 829.95 Set |
| 13820★ | Fawn              | 829.95 Set |

### 62 BEL-AIR 2-DR SEDAN

| Part # | Color Combination | Price      |
|--------|-------------------|------------|
| 13811★ | Red               | 829.95 Set |
| 13812★ | Blue              | 829.95 Set |
| 13813★ | Turquoise         | 829.95 Set |
| 13814★ | Green             | 829.95 Set |
| 13815★ | Fawn              | 829.95 Set |

### 62 BEL-AIR 4-DR WAGON (9-PASS)

| Part # | Color Combination | Price      |
|--------|-------------------|------------|
| 13826★ | Fawn              | 999.95 Set |
| 13827★ | Blue              | 999.95 Set |
| 13828★ | Turquoise         | 999.95 Set |
| 13829★ | Green             | 999.95 Set |
| 13830★ | Red               | 999.95 Set |

### 62 BEL-AIR 4-DR WAGON (6-PASS)

| Part # | Color Combination | Price      |
|--------|-------------------|------------|
| 13821★ | Fawn              | 829.95 Set |
| 13822★ | Blue              | 829.95 Set |
| 13823★ | Turquoise         | 829.95 Set |
| 13824★ | Green             | 829.95 Set |
| 13825★ | Red               | 829.95 Set |

### 62 BISCAYNE 4-DR SEDAN

| Part # | Color Combination | Price      |
|--------|-------------------|------------|
| 13834★ | Red               | 829.95 Set |
| 13835★ | Turquoise         | 829.95 Set |
| 13836★ | Fawn              | 829.95 Set |

★ = special order non-stocking item, please allow 4-6 weeks for delivery.

Interiors CANNOT be returned!

# Interior

## 1962 SEAT COVERS-CONTINUED

Presewn seat covers using correct grain vinyls and cloths. Set includes covers for the front and rear seats with all listings attached.

### 62 BISCAYNE 2-DR SEDAN

| Part # | Color Combination | Price      |
|--------|-------------------|------------|
| 13831★ | Red               | 999.95 Set |
| 13832★ | Turquoise         | 999.95 Set |
| 13833★ | Fawn              | 999.95 Set |



## 1963 SEAT COVERS

Presewn seat covers using correct grain vinyls and cloths. Set includes covers for the front and rear seats with all listings attached.

### 63 IMPALA CONVERTIBLE

| Part # | Color Combination | Price      |
|--------|-------------------|------------|
| 13844★ | Fawn              | 599.95 Set |
| 13845★ | Turquoise         | 599.95 Set |
| 13846★ | Red               | 599.95 Set |
| 13847★ | Blue              | 599.95 Set |
| 13848★ | Saddle            | 599.95 Set |
| 13849★ | Black             | 599.95 Set |



### 63 IMPALA 2-DR HARDTOP

| Part # | Color Combination | Price      |
|--------|-------------------|------------|
| 13858★ | Fawn              | 769.95 Set |
| 13859★ | Turquoise         | 769.95 Set |
| 13860★ | Red               | 769.95 Set |
| 13861★ | Blue              | 769.95 Set |
| 13862★ | Saddle            | 769.95 Set |
| 13863★ | Black             | 769.95 Set |

### 63 IMPALA SS 2-DR HARDTOP

| Part # | Color Combination | Price      |
|--------|-------------------|------------|
| 13851★ | Fawn              | 599.95 Set |
| 13852★ | Turquoise         | 599.95 Set |
| 13853★ | Red               | 599.95 Set |
| 13854★ | Blue              | 599.95 Set |
| 13855★ | Saddle            | 599.95 Set |
| 13856★ | Black             | 599.95 Set |

### 63 IMPALA SS CONVERTIBLE

| Part # | Color Combination | Price      |
|--------|-------------------|------------|
| 13837★ | Fawn              | 599.95 Set |
| 13838★ | Turquoise         | 599.95 Set |
| 13839★ | Red               | 599.95 Set |
| 13840★ | Blue              | 599.95 Set |
| 13841★ | Saddle            | 599.95 Set |
| 13842★ | Black             | 599.95 Set |

### 63 IMPALA 4-DR HARDTOP

| Part # | Color Combination | Price      |
|--------|-------------------|------------|
| 13865★ | Fawn              | 769.95 Set |
| 13866★ | Turquoise         | 769.95 Set |
| 13867★ | Red               | 769.95 Set |
| 13868★ | Blue              | 769.95 Set |
| 13869★ | Saddle            | 769.95 Set |
| 13870★ | Black             | 769.95 Set |
| 13871★ | Green             | 769.95 Set |

### 63 IMPALA 4-DR SEDAN

| Part # | Color Combination | Price      |
|--------|-------------------|------------|
| 13872★ | Fawn              | 769.95 Set |
| 13873★ | Turquoise         | 769.95 Set |
| 13874★ | Red               | 769.95 Set |
| 13875★ | Blue              | 769.95 Set |
| 13876★ | Saddle            | 769.95 Set |
| 13877★ | Black             | 769.95 Set |
| 13878★ | Green             | 769.95 Set |

### 63 IMPALA 4-DR WAGON (6-PASS)

| Part # | Color Combination | Price      |
|--------|-------------------|------------|
| 13879★ | Fawn              | 769.95 Set |
| 13880★ | Blue              | 769.95 Set |
| 13881★ | Turquoise         | 769.95 Set |
| 13882★ | Green             | 769.95 Set |
| 13883★ | Saddle            | 769.95 Set |
| 13884★ | Red               | 769.95 Set |
| 13885★ | Black             | 769.95 Set |

### 63 BEL-AIR 4-DR SEDAN

| Part # | Color Combination | Price      |
|--------|-------------------|------------|
| 13898★ | Turquoise         | 829.95 Set |
| 13899★ | Fawn              | 829.95 Set |
| 13900★ | Blue              | 829.95 Set |
| 13901★ | Red               | 829.95 Set |
| 13902★ | Green             | 829.95 Set |

### 63 IMPALA 4-DR WAGON (9-PASS)

| Part # | Color Combination | Price      |
|--------|-------------------|------------|
| 13886★ | Fawn              | 999.95 Set |
| 13887★ | Blue              | 999.95 Set |
| 13888★ | Turquoise         | 999.95 Set |
| 13889★ | Green             | 999.95 Set |
| 13890★ | Saddle            | 999.95 Set |
| 13891★ | Red               | 999.95 Set |
| 13892★ | Black             | 999.95 Set |

### 63 BISCAYNE 2-DR SEDAN

| Part # | Color Combination | Price      |
|--------|-------------------|------------|
| 13913★ | Red               | 829.95 Set |
| 13914★ | Fawn              | 829.95 Set |
| 13915★ | Turquoise         | 829.95 Set |

### 63 BISCAYNE 4-DR SEDAN

| Part # | Color Combination | Price      |
|--------|-------------------|------------|
| 13916★ | Red               | 829.95 Set |
| 13917★ | Fawn              | 829.95 Set |
| 13918★ | Turquoise         | 829.95 Set |

★ = special order non-stocking item, please allow 4-6 weeks for delivery.

Interiors CANNOT be returned!

# Interior

## 1963 SEAT COVERS-CONTINUED

Presewn seat covers using correct grain vinyls and cloths. Set includes covers for the front and rear seats with all listings attached.

### 63 BEL-AIR 2-DR SEDAN

| Part # | Color Combination | Price      |
|--------|-------------------|------------|
| 13893★ | Turquoise         | 829.95 Set |
| 13894★ | Fawn              | 829.95 Set |
| 13895★ | Blue              | 829.95 Set |
| 13896★ | Red               | 829.95 Set |
| 13897★ | Green             | 829.95 Set |



### 63 BEL-AIR 4-DR WAGON (9-PASS)

| Part # | Color Combination | Price      |
|--------|-------------------|------------|
| 13908★ | Fawn              | 999.95 Set |
| 13909★ | Turquoise         | 999.95 Set |
| 13910★ | Red               | 999.95 Set |
| 13911★ | Blue              | 999.95 Set |
| 13912★ | Green             | 999.95 Set |

## 1964 SEAT COVERS

Presewn seat covers using correct grain vinyls and cloths. Set includes covers for the front and rear seats with all listings attached.

### 64 IMPALA 4-DR SEDAN

| Part # | Color Combination | Price      |
|--------|-------------------|------------|
| 13960★ | Red               | 769.95 Set |
| 13961★ | Blue              | 769.95 Set |
| 13962★ | Saddle            | 769.95 Set |
| 13963★ | Black             | 769.95 Set |
| 13964★ | Oyster            | 769.95 Set |
| 13965★ | Turquoise         | 769.95 Set |
| 13966★ | Green             | 769.95 Set |



### 64 IMPALA CONVERTIBLE

| Part # | Color Combination | Price      |
|--------|-------------------|------------|
| 13929★ | Red               | 599.95 Set |
| 13930★ | Blue              | 599.95 Set |
| 13931★ | Saddle            | 599.95 Set |
| 13932★ | Black             | 599.95 Set |
| 13933★ | Oyster            | 599.95 Set |
| 13934★ | Turquoise         | 599.95 Set |

### 64 IMPALA 2-DR HARDTOP

| Part # | Color Combination | Price      |
|--------|-------------------|------------|
| 13946★ | Red               | 769.95 Set |
| 13947★ | Blue              | 769.95 Set |
| 13948★ | Saddle            | 769.95 Set |
| 13949★ | Black             | 769.95 Set |
| 13950★ | Oyster            | 769.95 Set |
| 13951★ | Turquoise         | 769.95 Set |

### 64 IMPALA 4-DR HARDTOP

| Part # | Color Combination | Price      |
|--------|-------------------|------------|
| 13953★ | Red               | 769.95 Set |
| 13954★ | Blue              | 769.95 Set |
| 13955★ | Saddle            | 769.95 Set |
| 13956★ | Black             | 769.95 Set |
| 13957★ | Oyster            | 769.95 Set |
| 13958★ | Turquoise         | 769.95 Set |
| 13959★ | Green             | 769.95 Set |

### 64 IMPALA SS 2-DR HARDTOP

| Part # | Color Combination | Price      |
|--------|-------------------|------------|
| 13936★ | Red               | 599.95 Set |
| 13937★ | Blue              | 599.95 Set |
| 13938★ | Saddle            | 599.95 Set |
| 13939★ | Black             | 599.95 Set |
| 13940★ | Oyster            | 599.95 Set |
| 13941★ | White/Turquoise   | 599.95 Set |
| 13942★ | White/Red         | 599.95 Set |
| 13944★ | Silver/Black      | 599.95 Set |
| 13945★ | White/Black       | 599.95 Set |

### 64 IMPALA SS CONVERTIBLE

| Part # | Color Combination | Price      |
|--------|-------------------|------------|
| 13919★ | Red               | 599.95 Set |
| 13920★ | Blue              | 599.95 Set |
| 13921★ | Saddle            | 599.95 Set |
| 13922★ | Black             | 599.95 Set |
| 13923★ | Oyster            | 599.95 Set |
| 13924★ | White/Turquoise   | 599.95 Set |
| 13925★ | White/Red         | 599.95 Set |
| 13927★ | Silver/Black      | 599.95 Set |
| 13928★ | White/Black       | 599.95 Set |



### 64 BEL-AIR 4-DR SEDAN

| Part # | Color Combination | Price      |
|--------|-------------------|------------|
| 13986★ | Oyster            | 829.95 Set |
| 13987★ | Turquoise         | 829.95 Set |
| 13988★ | Red               | 829.95 Set |
| 13989★ | Blue              | 829.95 Set |
| 13990★ | Green             | 829.95 Set |

### 64 BISCAYNE 2-DR SEDAN

| Part # | Color Combination | Price      |
|--------|-------------------|------------|
| 14001★ | Red               | 829.95 Set |
| 14002★ | Oyster            | 829.95 Set |
| 14003★ | Turquoise         | 829.95 Set |

★ = special order non-stocking item, please allow 4-6 weeks for delivery.

Interiors CANNOT be returned!

## Interior

### 1964 SEAT COVERS-CONTINUED

Presewn seat covers using correct grain vinyls and cloths. Set includes covers for the front and rear seats with all listings attached.

#### 64 IMPALA 4-DR WAGON (6-PASS)

| Part # | Color Combination | Price      |
|--------|-------------------|------------|
| 13967★ | Red               | 769.95 Set |
| 13968★ | Blue              | 769.95 Set |
| 13969★ | Saddle            | 769.95 Set |
| 13970★ | Black             | 769.95 Set |
| 13971★ | Oyster            | 769.95 Set |
| 13972★ | Turquoise         | 769.95 Set |
| 13973★ | Green             | 769.95 Set |

#### 64 BEL-AIR 4-DR WAGON (6-PASS)

| Part # | Color Combination | Price      |
|--------|-------------------|------------|
| 13991★ | Red               | 829.95 Set |
| 13992★ | Oyster            | 829.95 Set |
| 13993★ | Turquoise         | 829.95 Set |
| 13994★ | Green             | 829.95 Set |
| 13995★ | Blue              | 829.95 Set |

#### 64 BISCAYNE 4-DR SEDAN

| Part # | Color Combination | Price      |
|--------|-------------------|------------|
| 14004★ | Red               | 829.95 Set |
| 14005★ | Oyster            | 829.95 Set |
| 14006★ | Turquoise         | 829.95 Set |

#### 64 IMPALA 4-DR WAGON (9-PASS)

| Part # | Color Combination | Price      |
|--------|-------------------|------------|
| 13974★ | Red               | 999.95 Set |
| 13975★ | Blue              | 999.95 Set |
| 13976★ | Saddle            | 999.95 Set |
| 13977★ | Black             | 999.95 Set |
| 13978★ | Oyster            | 999.95 Set |
| 13979★ | Turquoise         | 999.95 Set |
| 13980★ | Green             | 999.95 Set |

#### 64 BEL-AIR 2-DR SEDAN

| Part # | Color Combination | Price      |
|--------|-------------------|------------|
| 13981★ | Oyster            | 829.95 Set |
| 13982★ | Turquoise         | 829.95 Set |
| 13983★ | Red               | 829.95 Set |
| 13984★ | Blue              | 829.95 Set |
| 13985★ | Green             | 829.95 Set |

#### 64 BEL-AIR 4-DR WAGON (9-PASS)

| Part # | Color Combination | Price      |
|--------|-------------------|------------|
| 13996★ | Red               | 999.95 Set |
| 13997★ | Oyster            | 999.95 Set |
| 13998★ | Turquoise         | 999.95 Set |
| 13999★ | Green             | 999.95 Set |
| 14000★ | Blue              | 999.95 Set |



### 1965 SEAT COVERS

Presewn seat covers using correct grain vinyls and cloths. Set includes covers for the front and rear seats with all listings attached.

#### 65 IMPALA CONVERTIBLE

| Part # | Color Combination | Price      |
|--------|-------------------|------------|
| 14016★ | Red               | 599.95 Set |
| 14017★ | Blue              | 599.95 Set |
| 14018★ | Black             | 599.95 Set |
| 14019★ | Fawn              | 599.95 Set |
| 14020★ | Turquoise         | 599.95 Set |
| 14021★ | Saddle            | 599.95 Set |

#### 65 IMPALA SS 2-DR HARDTOP

| Part # | Color Combination | Price      |
|--------|-------------------|------------|
| 14023★ | Red               | 599.95 Set |
| 14024★ | Blue              | 599.95 Set |
| 14025★ | Saddle            | 599.95 Set |
| 14026★ | Black             | 599.95 Set |
| 14027★ | Fawn              | 599.95 Set |
| 14028★ | White/Turquoise   | 599.95 Set |
| 14029★ | White/Black       | 599.95 Set |
| 14030★ | Slate             | 579.95 Set |
| 14031★ | White/Red         | 599.95 Set |

#### 65 IMPALA 2-DR HARDTOP (CLOTH/VINYL)

| Part # | Color Combination | Price      |
|--------|-------------------|------------|
| 14039★ | Red               | 769.95 Set |
| 14040★ | Blue              | 769.95 Set |
| 14041★ | Black             | 769.95 Set |
| 14042★ | Fawn              | 769.95 Set |
| 14043★ | Turquoise         | 769.95 Set |
| 14044★ | Green             | 769.95 Set |
| 14045★ | Saddle            | 769.95 Set |



#### 65 IMPALA 4-DR WAGON (6-PASS)

| Part # | Color Combination | Price      |
|--------|-------------------|------------|
| 15395★ | Fawn              | 769.95 Set |
| 15396★ | Turquoise         | 769.95 Set |
| 15397★ | Red               | 769.95 Set |
| 15398★ | Light Blue        | 769.95 Set |
| 15399★ | Light Green       | 769.95 Set |
| 15400★ | Saddle            | 769.95 Set |

#### 65 BEL-AIR 2-DR SEDAN

| Part # | Color Combination | Price      |
|--------|-------------------|------------|
| 15991★ | Red               | 829.95 Set |
| 15992★ | Blue              | 829.95 Set |
| 15993★ | Green             | 829.95 Set |
| 15994★ | Turquoise         | 829.95 Set |
| 15995★ | Fawn              | 829.95 Set |

★ = special order non-stocking item, please allow 4-6 weeks for delivery.

Interiors CANNOT be returned!

# Interior

## 1965 SEAT COVERS-CONTINUED

Presewn seat covers using correct grain vinyls and cloths. Set includes covers for the front and rear seats with all listings attached.

### 65 IMPALA 2-DR HARDTOP (ALL VINYL)

| Part # | Color Combination | Price      |
|--------|-------------------|------------|
| 14032★ | Red               | 599.95 Set |
| 14033★ | Blue              | 599.95 Set |
| 14034★ | Black             | 599.95 Set |
| 14035★ | Fawn              | 599.95 Set |
| 14036★ | Turquoise         | 599.95 Set |
| 14037★ | Saddle            | 599.95 Set |

### 65 IMPALA 4-DR HARDTOP

| Part # | Color Combination | Price      |
|--------|-------------------|------------|
| 14046★ | Red               | 809.95 Set |
| 14047★ | Blue              | 809.95 Set |
| 14048★ | Black             | 809.95 Set |
| 14049★ | Fawn              | 809.95 Set |
| 14050★ | Turquoise         | 809.95 Set |
| 14051★ | Green             | 809.95 Set |
| 14052★ | Saddle            | 809.95 Set |

### 65 IMPALA SS CONVERTIBLE

| Part # | Color Combination | Price      |
|--------|-------------------|------------|
| 14007★ | Red               | 599.95 Set |
| 14008★ | Blue              | 599.95 Set |
| 14009★ | Saddle            | 599.95 Set |
| 14010★ | Black             | 599.95 Set |
| 14011★ | Fawn              | 599.95 Set |
| 14012★ | White/Turquoise   | 599.95 Set |
| 14013★ | White/Black       | 599.95 Set |
| 14014★ | Slate             | 599.95 Set |
| 14015★ | White/Red         | 599.95 Set |

### 65 BISCAYNE 2-DR SEDAN

| Part # | Color Combination | Price      |
|--------|-------------------|------------|
| 14060★ | Fawn              | 829.95 Set |
| 14061★ | Turquoise         | 829.95 Set |
| 14062★ | Red               | 829.95 Set |

### 65 IMPALA 4-DR SEDAN

| Part # | Color Combination | Price      |
|--------|-------------------|------------|
| 14053★ | Red               | 809.95 Set |
| 14054★ | Blue              | 809.95 Set |
| 14055★ | Black             | 809.95 Set |
| 14056★ | Fawn              | 809.95 Set |
| 14057★ | Turquoise         | 809.95 Set |
| 14058★ | Green             | 809.95 Set |
| 14059★ | Saddle            | 809.95 Set |

### 65 BISCAYNE 4-DR SEDAN

| Part # | Color Combination | Price      |
|--------|-------------------|------------|
| 16404★ | Fawn              | 869.95 Set |
| 16405★ | Red               | 869.95 Set |
| 16406★ | Turquoise         | 869.95 Set |

## 1966 SEAT COVERS

Presewn seat covers using correct grain vinyls and cloths. Set includes covers for the front and rear seats with all listings attached.

### 66 IMPALA SS CONVERTIBLE

| Part # | Color Combination | Price      |
|--------|-------------------|------------|
| 14063★ | Black             | 599.95 Set |
| 14064★ | White             | 599.95 Set |
| 14065★ | Red               | 599.95 Set |
| 14066★ | Fawn              | 599.95 Set |
| 14067★ | Turquoise         | 599.95 Set |
| 14068★ | Blue              | 599.95 Set |
| 14070★ | Bright Blue       | 599.95 Set |

### 66 IMPALA CONVERTIBLE

| Part # | Color Combination | Price      |
|--------|-------------------|------------|
| 14071★ | Black             | 599.95 Set |
| 14072★ | White             | 599.95 Set |
| 14073★ | Red               | 599.95 Set |
| 14074★ | Fawn              | 599.95 Set |
| 14075★ | Turquoise         | 599.95 Set |
| 14076★ | Blue              | 599.95 Set |

### 66 IMPALA SS 2-DR HARDTOP

| Part # | Color Combination | Price      |
|--------|-------------------|------------|
| 14078★ | Black             | 599.95 Set |
| 14079★ | White             | 599.95 Set |
| 14080★ | Red               | 599.95 Set |
| 14081★ | Fawn              | 599.95 Set |
| 14082★ | Turquoise         | 599.95 Set |
| 14083★ | Blue              | 599.95 Set |
| 14085★ | Bright Blue       | 599.95 Set |

### 66 IMPALA 2-DR HARDTOP (CLOTH/VINYL)

| Part # | Color Combination | Price      |
|--------|-------------------|------------|
| 14093★ | Black             | 769.95 Set |
| 14094★ | Red               | 769.95 Set |
| 14095★ | Fawn              | 769.95 Set |
| 14096★ | Turquoise         | 769.95 Set |
| 14097★ | Blue              | 769.95 Set |
| 14098★ | Green             | 769.95 Set |



### 66 IMPALA 2-DR HARDTOP (ALL VINYL)

| Part # | Color Combination | Price      |
|--------|-------------------|------------|
| 14086★ | Black             | 599.95 Set |
| 14087★ | White             | 599.95 Set |
| 14088★ | Red               | 599.95 Set |
| 14089★ | Fawn              | 599.95 Set |
| 14090★ | Turquoise         | 599.95 Set |
| 14091★ | Blue              | 509.95 Set |

### 66 CAPRICE 2-DR HARDTOP (CLOTH)

| Part # | Color Combination | Price      |
|--------|-------------------|------------|
| 15983★ | Blue              | 829.95 Set |
| 15984★ | Fawn              | 829.95 Set |
| 15985★ | Black             | 809.95 Set |

★ = special order non-stocking item, please allow 4-6 weeks for delivery.

Interiors CANNOT be returned!

# Interior

## 1966 SEAT COVERS-CONTINUED

Presewn seat covers using correct grain vinyls and cloths. Set includes covers for the front and rear seats with all listings attached.

### 66 IMPALA 4-DR HARDTOP

| Part # | Color Combination | Price      |
|--------|-------------------|------------|
| 14099★ | Black             | 809.95 Set |
| 14100★ | Red               | 809.95 Set |
| 14101★ | Fawn              | 809.95 Set |
| 14102★ | Turquoise         | 809.95 Set |
| 14103★ | Blue              | 809.95 Set |
| 14104★ | Green             | 809.95 Set |

### 66 BEL-AIR 2-DR SEDAN

| Part # | Color Combination | Price      |
|--------|-------------------|------------|
| 16407★ | Blue              | 829.95 Set |
| 16408★ | Fawn              | 829.95 Set |
| 16409★ | Red               | 829.95 Set |
| 16410★ | Turquoise         | 829.95 Set |

### 66 IMPALA 4-DR SEDAN

| Part # | Color Combination | Price      |
|--------|-------------------|------------|
| 14105★ | Black             | 809.95 Set |
| 14106★ | Red               | 809.95 Set |
| 14107★ | Fawn              | 809.95 Set |
| 14108★ | Turquoise         | 809.95 Set |
| 14109★ | Blue              | 809.95 Set |
| 14110★ | Green             | 809.95 Set |

### 66 BEL-AIR 4-DR SEDAN

| Part # | Color Combination | Price      |
|--------|-------------------|------------|
| 16411★ | Blue              | 829.95 Set |
| 16412★ | Fawn              | 829.95 Set |
| 6413★  | Red               | 829.95 Set |
| 16414★ | Turquoise         | 829.95 Set |

### 66 IMPALA 4-DR WAGON (6-PASS)

| Part # | Color Combination | Price      |
|--------|-------------------|------------|
| 16415★ | Blue              | 729.95 Set |
| 16416★ | Fawn              | 729.95 Set |
| 6417★  | Red               | 729.95 Set |
| 16418★ | Turquoise         | 729.95 Set |

### 66 BISCAYNE 2-DR SEDAN

| Part # | Color Combination | Price      |
|--------|-------------------|------------|
| 14111★ | Blue              | 829.95 Set |
| 14112★ | Fawn              | 829.95 Set |
| 14113★ | Red               | 829.95 Set |

### BISCAYNE 4-DR SEDAN

| Part # | Color Combination | Price      |
|--------|-------------------|------------|
| 16419★ | Blue              | 829.95 Set |
| 16420★ | Fawn              | 829.95 Set |
| 16421★ | Red               | 829.95 Set |

## 1967 SEAT COVERS

Presewn seat covers using correct grain vinyls and cloths. Set includes covers for the front and rear seats with all listings attached.

### 67 IMPALA SS CONVERTIBLE W/BUCKETS

| Part # | Color Combination | Price      |
|--------|-------------------|------------|
| 14114★ | Black             | 509.95 Set |
| 14115★ | Off White         | 509.95 Set |
| 14116★ | Red               | 509.95 Set |
| 14117★ | Bright Blue       | 509.95 Set |
| 14118★ | Gold              | 509.95 Set |

### 67 IMPALA SS CONVERTIBLE W/BENCH

| Part # | Color Combination | Price      |
|--------|-------------------|------------|
| 14119★ | Black             | 509.95 Set |
| 14120★ | Gold              | 509.95 Set |
| 14121★ | Red               | 509.95 Set |
| 14122★ | Off White         | 509.95 Set |
| 14123★ | Bright Blue       | 509.95 Set |

### 67 IMPALA 2-DR HARDTOP W/VINYL BENCH

| Part # | Color Combination | Price      |
|--------|-------------------|------------|
| 14141★ | Black             | 509.95 Set |
| 14142★ | Off White         | 509.95 Set |
| 14143★ | Red               | 509.95 Set |
| 14144★ | Bright Blue       | 509.95 Set |
| 14145★ | Gold              | 509.95 Set |
| 14146★ | Light Blue        | 509.95 Set |
| 14147★ | Turquoise         | 509.95 Set |

### 67 IMPALA SS 2-DR HARDTOP W/BUCKETS

| Part # | Color Combination | Price      |
|--------|-------------------|------------|
| 14131★ | Black             | 509.95 Set |
| 14132★ | Off White         | 509.95 Set |
| 14133★ | Red               | 509.95 Set |
| 14134★ | Bright Blue       | 509.95 Set |
| 14135★ | Gold              | 509.95 Set |

### 67 IMPALA CONVERTIBLE

| Part # | Color Combination | Price      |
|--------|-------------------|------------|
| 14124★ | Black             | 509.95 Set |
| 14125★ | Off White         | 509.95 Set |
| 14126★ | Red               | 509.95 Set |
| 14127★ | Bright Blue       | 509.95 Set |
| 14128★ | Gold              | 509.95 Set |
| 14129★ | Light Blue        | 509.95 Set |
| 14130★ | Turquoise         | 509.95 Set |

### 67 IMPALA 4-DR HARDTOP/SEDAN

| Part # | Color Combination | Price      |
|--------|-------------------|------------|
| 16422★ | Blue              | 809.95 Set |
| 16423★ | Gold              | 809.95 Set |
| 16424★ | Maroon            | 809.95 Set |
| 16425★ | Turquoise         | 809.95 Set |



### 67 IMPALA SS 2-DR HARDTOP W/BENCH

| Part # | Color Combination | Price      |
|--------|-------------------|------------|
| 14136★ | Black             | 509.95 Set |
| 14137★ | Off White         | 509.95 Set |
| 14138★ | Red               | 509.95 Set |
| 14139★ | Bright Blue       | 509.95 Set |
| 14140★ | Gold              | 509.95 Set |

### 67 IMPALA 2-DR HARDTOP W/CLOTH BENCH

| Part # | Color Combination | Price      |
|--------|-------------------|------------|
| 14148★ | Black             | 769.95 Set |
| 14149★ | Maroon            | 769.95 Set |
| 14150★ | Turquoise         | 769.95 Set |
| 14151★ | Gold              | 769.95 Set |
| 14152★ | Blue              | 749.95 Set |

★ = special order non-stocking item, please allow 4-6 weeks for delivery.

Interiors CANNOT be returned!

# Interior

## 1967 SEAT COVERS-CONTINUED

Presewn seat covers using correct grain vinyls and cloths. Set includes covers for the front and rear seats with all listings attached.

### 67 IMPALA 4-DR WAGON (6-PASS)

| Part # | Color Combination | Price      |
|--------|-------------------|------------|
| 16426★ | Gold              | 769.95 Set |
| 16427★ | Blue              | 769.95 Set |
| 16428★ | Red               | 769.95 Set |
| 16429★ | Turquoise         | 769.95 Set |

### 67 BISCAYNE 2-DR SEDAN

| Part # | Color Combination | Price      |
|--------|-------------------|------------|
| 16430★ | Fawn              | 809.95 Set |
| 16431★ | Light Blue        | 809.95 Set |
| 16432★ | Black             | 809.95 Set |

## 1968 SEAT COVERS

Presewn seat covers using correct grain vinyls and cloths. Set includes covers for the front and rear seats with all listings attached.

### 68 IMPALA 2-DR HARDTOP (CLOTH BENCH)

| Part # | Color Combination | Price      |
|--------|-------------------|------------|
| 14175★ | Black             | 749.95 Set |
| 14176★ | Medium Blue       | 749.95 Set |
| 14177★ | Ivy Gold          | 749.95 Set |
| 14178★ | Gray/Green        | 749.95 Set |
| 14179★ | Turquoise         | 749.95 Set |

### 68 IMPALA CONVERTIBLE

| Part # | Color Combination | Price      |
|--------|-------------------|------------|
| 14159★ | Black             | 509.95 Set |
| 14160★ | Ivy Gold          | 509.95 Set |
| 14161★ | Parchment         | 509.95 Set |
| 14162★ | Teal Blue         | 509.95 Set |
| 14163★ | Red               | 509.95 Set |

### 68 IMPALA SS 2-DR HARDTOP

| Part # | Color Combination | Price      |
|--------|-------------------|------------|
| 14164★ | Black             | 509.95 Set |
| 14165★ | Red               | 509.95 Set |
| 14166★ | Parchment         | 509.95 Set |
| 14167★ | Blue              | 509.95 Set |
| 14168★ | Ivy Gold          | 509.95 Set |
| 14169★ | Black/Parchment   | 509.95 Set |

### 68 IMPALA 2-DR HARDTOP (VINYL BENCH)

| Part # | Color Combination | Price      |
|--------|-------------------|------------|
| 14170★ | Black             | 509.95 Set |
| 14171★ | Ivy Gold          | 509.95 Set |
| 14172★ | Parchment         | 509.95 Set |
| 14173★ | Medium Blue       | 509.95 Set |
| 14174★ | Teal Blue         | 509.95 Set |

### 68 IMPALA SS CONVERTIBLE

| Part # | Color Combination | Price      |
|--------|-------------------|------------|
| 14153★ | Black             | 509.95 Set |
| 14154★ | Red               | 509.95 Set |
| 14155★ | Parchment         | 509.95 Set |
| 14156★ | Blue              | 509.95 Set |
| 14157★ | Ivy Gold          | 509.95 Set |
| 14158★ | Black/Parchment   | 509.95 Set |

### 68 BISCAYNE 2-DR SEDAN

| Part # | Color Combination | Price      |
|--------|-------------------|------------|
| 14180★ | Black             | 809.95 Set |
| 14181★ | Medium Blue       | 809.95 Set |
| 14182★ | Ivy Gold          | 809.95 Set |

## 1969 SEAT COVERS

Presewn seat covers using correct grain vinyls and cloths. Set includes covers for the front and rear seats with all listings attached.

### 69 IMPALA CONVERTIBLE (VINYL BUCKETS)

| Part # | Color Combination | Price      |
|--------|-------------------|------------|
| 14183★ | Black             | 509.95 Set |
| 14184★ | Red               | 509.95 Set |
| 14185★ | Parchment         | 509.95 Set |
| 14186★ | Dark Blue         | 509.95 Set |
| 14187★ | Ivy Green         | 509.95 Set |

### 69 IMPALA 2-DR HARDTOP (VINYL BENCH)

| Part # | Color Combination | Price      |
|--------|-------------------|------------|
| 14198★ | Black             | 509.95 Set |
| 14199★ | Red               | 509.95 Set |
| 14200★ | Parchment         | 509.95 Set |
| 14201★ | Dark Blue         | 509.95 Set |
| 14202★ | Ivy Green         | 509.95 Set |

### 69 IMPALA CONVERTIBLE (VINYL BENCH)

| Part # | Color Combination | Price      |
|--------|-------------------|------------|
| 14188★ | Black             | 509.95 Set |
| 14189★ | Red               | 509.95 Set |
| 14190★ | Parchment         | 509.95 Set |
| 14191★ | Dark Blue         | 509.95 Set |
| 14192★ | Ivy Green         | 509.95 Set |

### 69 IMPALA 2-DR HARDTOP (CLOTH BENCH)

| Part # | Color Combination | Price      |
|--------|-------------------|------------|
| 14203★ | Black             | 769.95 Set |
| 14204★ | Dark Blue         | 769.95 Set |
| 14205★ | Dark Green        | 769.95 Set |
| 14206★ | Ivy Green         | 769.95 Set |
| 14207★ | Turquoise         | 769.95 Set |
| 14208★ | Gold              | 769.95 Set |

### 69 IMPALA 2-DR HARDTOP (VINYL BUCKETS)

| Part # | Color Combination | Price      |
|--------|-------------------|------------|
| 14193★ | Black             | 509.95 Set |
| 14194★ | Red               | 509.95 Set |
| 14195★ | Parchment         | 509.95 Set |
| 14196★ | Dark Blue         | 509.95 Set |
| 14197★ | Ivy Green         | 509.95 Set |

★ = special order non-stocking item, please allow 4-6 weeks for delivery.

Interiors CANNOT be returned!

# Interior

## 1970 SEAT COVERS

Presewn seat covers using correct grain vinyls and cloths. Set includes covers for athe front and rear seats with all listings attached.

### 70 IMPALA CONVERTIBLE

| Part # | Color Combination | Price      |
|--------|-------------------|------------|
| 14209★ | Black             | 509.95 Set |
| 14210★ | Dark Green        | 509.95 Set |
| 14211★ | Red               | 509.95 Set |
| 14212★ | Light Saddle      | 509.95 Set |

### 70 IMPALA 2-DR HARDTOP (VINYL BENCH)

| Part # | Color Combination | Price      |
|--------|-------------------|------------|
| 14213★ | Black             | 509.95 Set |
| 14214★ | Medium Blue       | 509.95 Set |
| 14215★ | Red               | 509.95 Set |
| 14216★ | Dark Green        | 509.95 Set |
| 14217★ | Light Saddle      | 509.95 Set |
| 14218★ | Sandalwood        | 509.95 Set |

### 70 IMPALA 2-DR HARDTOP (CLOTH BENCH)

| Part # | Color Combination | Price      |
|--------|-------------------|------------|
| 14219★ | Medium Blue       | 769.95 Set |
| 14220★ | Gold              | 769.95 Set |
| 14221★ | Turquoise         | 769.95 Set |
| 14222★ | Dark Green        | 769.95 Set |
| 14223★ | Black             | 769.95 Set |

## 1958 DOOR PANELS

These front and rear door panels are completely assembled and ready to install with nails welded to metal edge door bands. The sets include front and rear armrest covers, Piston covers on Convertible models, colored kick panels to match your original interior and presewn windlace.

### 58 IMPALA CONVERTIBLE

| Part # | Color Combination      | Price      |
|--------|------------------------|------------|
| 14224★ | Red/Silver/Black       | 709.95 Set |
| 14225★ | Black/Silver/Turquoise | 709.95 Set |
| 14226★ | Green/Silver/Green     | 709.95 Set |
| 14227★ | Blue/Silver/Blue       | 709.95 Set |
| 14228★ | Turquoise/Silver/Black | 709.95 Set |
| 14229★ | Gold/Beige/Copper      | 709.95 Set |
| 14230★ | Coral/Coral/Coral      | 709.95 Set |

### 58 IMPALA 2-DR HARDTOP

| Part # | Color Combination      | Price      |
|--------|------------------------|------------|
| 14231★ | Black/Silver/Turquoise | 709.95 Set |
| 14232★ | Green/Silver/Green     | 709.95 Set |
| 14233★ | Blue/Silver/Blue       | 709.95 Set |
| 14234★ | Turquoise/Silver/Black | 709.95 Set |
| 14235★ | Gold/Beige/Copper      | 709.95 Set |
| 14236★ | Red/Silver/Black       | 709.95 Set |
| 14237★ | Coral/Coral/Coral      | 709.95 Set |

### 58 BEL-AIR 2-DR HARDTOP

| Part # | Color Combination | Price      |
|--------|-------------------|------------|
| 14238★ | Silver            | 839.95 Set |
| 14239★ | Green             | 839.95 Set |
| 14240★ | Blue              | 839.95 Set |
| 14241★ | Turquoise         | 839.95 Set |
| 14242★ | Gold              | 839.95 Set |
| 14243★ | Coral             | 839.95 Set |

### 58 BEL-AIR 4-DR HARDTOP

| Part # | Color Combination | Price      |
|--------|-------------------|------------|
| 14244★ | Silver            | 889.95 Set |
| 14245★ | Green             | 889.95 Set |
| 14246★ | Blue              | 889.95 Set |
| 14247★ | Turquoise         | 889.95 Set |
| 14248★ | Gold              | 889.95 Set |
| 14249★ | Coral             | 889.95 Set |

### 58 BEL-AIR 4-DR SEDAN

| Part # | Color Combination | Price      |
|--------|-------------------|------------|
| 14256★ | Silver            | 889.95 Set |
| 14257★ | Green             | 889.95 Set |
| 14258★ | Blue              | 889.95 Set |
| 14259★ | Turquoise         | 889.95 Set |
| 14260★ | Gold              | 889.95 Set |
| 14261★ | Coral             | 889.95 Set |



### 58 BISCAYNE 4-DR SEDAN

| Part # | Color Combination | Price      |
|--------|-------------------|------------|
| 16437★ | Blue              | 889.95 Set |
| 16438★ | Gold/Silver       | 889.95 Set |
| 16439★ | Green             | 889.95 Set |
| 16440★ | Gray/Silver       | 889.95 Set |

### 58 BISCAYNE 2-DR SEDAN

| Part # | Color Combination | Price      |
|--------|-------------------|------------|
| 16433★ | Blue              | 839.95 Set |
| 16434★ | Gold/Silver       | 839.95 Set |
| 16435★ | Green             | 839.95 Set |
| 16436★ | Gray/Silver       | 839.95 Set |

### 58 BEL-AIR 2-DR SEDAN

| Part # | Color Combination | Price      |
|--------|-------------------|------------|
| 14250★ | Silver            | 839.95 Set |
| 14251★ | Green             | 839.95 Set |
| 14252★ | Blue              | 839.95 Set |
| 14253★ | Turquoise         | 839.95 Set |
| 14254★ | Gold              | 839.95 Set |
| 14255★ | Coral             | 839.95 Set |

### 58 NOMAD 4-DR WAGON

| Part # | Color Combination | Price      |
|--------|-------------------|------------|
| 14262★ | Silver            | 899.95 Set |
| 14263★ | Green             | 899.95 Set |
| 14264★ | Blue              | 899.95 Set |
| 14265★ | Turquoise         | 899.95 Set |
| 14266★ | Gold              | 899.95 Set |
| 14267★ | Coral             | 899.95 Set |

★ = special order non-stocking item, please allow 4-6 weeks for delivery.

Interiors CANNOT be returned!

# Interior

## 1959 DOOR PANELS

Correct side panel sets with original brushed vinyl insert design. Side panels come ready to install with welded door nail fasteners, colored kick panels, windlace set, and material to recover armrests. Hardtop and Convertible models will have pre-sewn covers for the armrests. Before these can be built we will need the top rails out of your door panels. They need to be cleaned and painted ready to install.

### 59 IMPALA CONVERTIBLE

| Part # | Color Combination | Price      |
|--------|-------------------|------------|
| 14268★ | Copper            | 869.95 Set |
| 14269★ | Red               | 869.95 Set |
| 14270★ | Blue              | 869.95 Set |
| 14271★ | Turquoise         | 869.95 Set |
| 14272★ | Green             | 869.95 Set |
| 14273★ | Gray              | 869.95 Set |

### 59 IMPALA 4-DR SEDAN

| Part # | Color Combination | Price      |
|--------|-------------------|------------|
| 14286★ | Gray              | 899.95 Set |
| 14287★ | Green             | 899.95 Set |
| 14288★ | Blue              | 899.95 Set |
| 14289★ | Copper            | 899.95 Set |
| 14290★ | Turquoise         | 899.95 Set |
| 14291★ | Red               | 899.95 Set |

### 59 BROOKWOOD 2-DR WAGON

| Part # | Color Combination | Price      |
|--------|-------------------|------------|
| 16441★ | Blue              | 899.95 Set |
| 16442★ | Gray              | 899.95 Set |
| 16443★ | Green             | 899.95 Set |

### 59 IMPALA 2-DR HARDTOP

| Part # | Color Combination | Price      |
|--------|-------------------|------------|
| 14274★ | Copper            | 869.95 Set |
| 14275★ | Red               | 869.95 Set |
| 14276★ | Blue              | 869.95 Set |
| 14277★ | Turquoise         | 869.95 Set |
| 14278★ | Green             | 869.95 Set |
| 14279★ | Gray              | 869.95 Set |

### 59 IMPALA 4-DR WAGON

| Part # | Color Combination | Price      |
|--------|-------------------|------------|
| 10060★ | Gray/White        | 899.95 Set |
| 10061★ | Copper            | 899.95 Set |
| 10062★ | Green             | 899.95 Set |
| 10063★ | Blue              | 899.95 Set |
| 10064★ | Turquoise         | 899.95 Set |
| 10065★ | Red               | 899.95 Set |

### 59 IMPALA 4-DR HARDTOP

| Part # | Color Combination | Price      |
|--------|-------------------|------------|
| 14280★ | Gray              | 899.95 Set |
| 14281★ | Green             | 899.95 Set |
| 14282★ | Blue              | 899.95 Set |
| 14283★ | Copper            | 899.95 Set |
| 14284★ | Turquoise         | 899.95 Set |
| 14285★ | Red               | 899.95 Set |



### 59 EL CAMINO

| Part # | Color Combination | Price      |
|--------|-------------------|------------|
| 14292★ | Copper            | 639.95 Set |
| 14293★ | Red               | 639.95 Set |
| 14294★ | Blue              | 639.95 Set |
| 14295★ | Turquoise         | 639.95 Set |
| 14296★ | Green             | 639.95 Set |
| 14297★ | Gray              | 639.95 Set |

## 1960 DOOR PANELS

Correct side panels sets with original-type patterned vinyl and cloth materials. The door and rear panels come ready to install with welded door nail fasteners, colored kick panels, windlace, and material to recover armrests. Hardtop and Convertible models will have pre-sewn covers for the armrests. Before these can be built we will need the top rails out of your door panels. They need to be cleaned and painted ready to install.

### 60 IMPALA CONVERTIBLE

| Part # | Color Combination | Price      |
|--------|-------------------|------------|
| 14298★ | Copper            | 869.95 Set |
| 14299★ | Red               | 869.95 Set |
| 14300★ | Black             | 869.95 Set |
| 14301★ | Turquoise         | 869.95 Set |
| 14302★ | Blue              | 869.95 Set |
| 14303★ | Green             | 869.95 Set |

### 60 IMPALA 2-DR HARDTOP

| Part # | Color Combination | Price      |
|--------|-------------------|------------|
| 14304★ | Copper            | 869.95 Set |
| 14305★ | Red               | 869.95 Set |
| 14306★ | Black             | 869.95 Set |
| 14307★ | Turquoise         | 869.95 Set |
| 14308★ | Blue              | 869.95 Set |
| 14309★ | Green             | 869.95 Set |

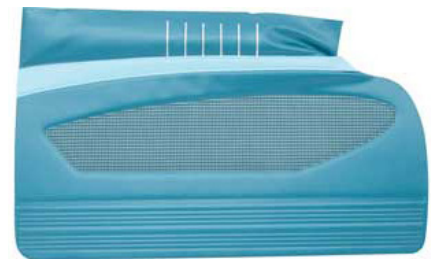

### 60 BROOKWOOD 2-DR WAGON

| Part # | Color Combination | Price      |
|--------|-------------------|------------|
| 16449★ | Blue/Blue         | 899.95 Set |
| 16450★ | Gray              | 899.95 Set |
| 16451★ | Green/Green       | 899.95 Set |

★ = special order non-stocking item, please allow 4-6 weeks for delivery.

Interiors CANNOT be returned!

# Interior

## 1960 DOOR PANELS

Correct side panels sets with original-type patterned vinyl and cloth materials. The door and rear panels come ready to install with welded door nail fasteners, colored kick panels, windlace, and material to recover armrests. Hardtop and Convertible models will have presewn covers for the armrests. Before these can be built we will need the top rails out of your door panels. They need to be cleaned and painted ready to install.

### 60 IMPALA 4-DR HARDTOP

| Part # | Color Combination | Price      |
|--------|-------------------|------------|
| 14310★ | Black             | 899.95 Set |
| 14311★ | Green             | 899.95 Set |
| 14312★ | Blue              | 899.95 Set |
| 14313★ | Copper            | 899.95 Set |
| 14314★ | Turquoise         | 899.95 Set |
| 14315★ | Red               | 899.95 Set |

### 60 BEL-AIR 2-DR SEDAN

| Part # | Color Combination | Price      |
|--------|-------------------|------------|
| 14328★ | Gray              | 839.95 Set |
| 14329★ | Green             | 839.95 Set |
| 14330★ | Blue              | 839.95 Set |
| 14331★ | Copper            | 839.95 Set |
| 14332★ | Turquoise         | 819.95 Set |

### 60 EL CAMINO

| Part # | Color Combination | Price      |
|--------|-------------------|------------|
| 14333★ | Copper            | 639.95 Set |
| 14334★ | Red               | 639.95 Set |
| 14335★ | Black             | 639.95 Set |
| 14336★ | Turquoise         | 639.95 Set |
| 14337★ | Blue              | 639.95 Set |
| 14338★ | Green             | 639.95 Set |

### 60 IMPALA 4-DR SEDAN

| Part # | Color Combination | Price      |
|--------|-------------------|------------|
| 14316★ | Black             | 899.95 Set |
| 14317★ | Green             | 899.95 Set |
| 14318★ | Blue              | 899.95 Set |
| 14319★ | Copper            | 899.95 Set |
| 14320★ | Turquoise         | 899.95 Set |
| 14321★ | Red               | 899.95 Set |

### 60 BEL-AIR 4-DR SEDAN

| Part # | Color Combination | Price      |
|--------|-------------------|------------|
| 16444★ | Gray/Silver       | 899.95 Set |
| 16445★ | Green             | 899.95 Set |
| 16446★ | Blue              | 899.95 Set |
| 16447★ | Copper            | 899.95 Set |
| 16448★ | Turquoise         | 899.95 Set |

### 60 BEL-AIR 2-DR HARDTOP

| Part # | Color Combination   | Price      |
|--------|---------------------|------------|
| 11036★ | Gray/White          | 839.95 Set |
| 11037★ | Green/Green         | 839.95 Set |
| 11038★ | Blue/Blue           | 839.95 Set |
| 11039★ | Copper/Copper       | 839.95 Set |
| 11040★ | Turquoise/Turquoise | 809.95 Set |

### 60 IMPALA 4-DR WAGON

| Part # | Color Combination | Price      |
|--------|-------------------|------------|
| 14322★ | Red               | 899.95 Set |
| 14323★ | Black             | 899.95 Set |
| 14324★ | Turquoise         | 899.95 Set |
| 14325★ | Blue              | 899.95 Set |
| 14326★ | Green             | 899.95 Set |
| 14327★ | Copper            | 899.95 Set |

## 1961 DOOR PANELS

Ready to install with your rails! Front and rear trim panels are assembled on new boards featuring correct grained vinyl and cloth materials. Set includes material to recover armrests, windlace, colored kick panels. Hardtop and Convertible models will have presewn covers for the armrests. Before these can be built we will need the top rails out of your door panels. They need to be cleaned and painted ready to install.

### 61 IMPALA CONVERTIBLE

| Part # | Color Combination | Price      |
|--------|-------------------|------------|
| 14339★ | Red               | 869.95 Set |
| 14340★ | Fawn              | 869.95 Set |
| 14341★ | Blue              | 869.95 Set |
| 14342★ | Green             | 869.95 Set |
| 14343★ | Turquoise         | 869.95 Set |
| 14344★ | Gray              | 869.95 Set |



### 61 IMPALA 4-DR HARDTOP

| Part # | Color Combination | Price      |
|--------|-------------------|------------|
| 14351★ | Gray              | 899.95 Set |
| 14352★ | Red               | 899.95 Set |
| 14353★ | Green             | 899.95 Set |
| 14354★ | Blue              | 899.95 Set |
| 14355★ | Fawn              | 899.95 Set |
| 14356★ | Turquoise         | 899.95 Set |

★ = special order non-stocking item, please allow 4-6 weeks for delivery.

Interiors CANNOT be returned!

# Interior

## 1961 DOOR PANELS-CONTINUED

Ready to install with your rails! Front and rear trim panels are assembled on new boards featuring correct grained vinyl and cloth materials. Set includes material to recover armrests, windlace, colored kick panels. Hardtop and Convertible models will have pre-sewn covers for the armrests. Before these can be built we will need the top rails out of your door panels. They need to be cleaned and painted ready to install.

### 61 IMPALA 2-DR SEDAN

| Part # | Color Combination | Price      |
|--------|-------------------|------------|
| 14357★ | Gray              | 869.95 Set |
| 14358★ | Red               | 869.95 Set |
| 14359★ | Green             | 869.95 Set |
| 14360★ | Blue              | 869.95 Set |
| 14361★ | Fawn              | 869.95 Set |
| 14362★ | Turquoise         | 869.95 Set |

### 61 BEL-AIR 2-DR HARDTOP

| Part # | Color Combination | Price      |
|--------|-------------------|------------|
| 14375★ | Gray              | 839.95 Set |
| 14376★ | Green             | 839.95 Set |
| 14377★ | Blue              | 839.95 Set |
| 14378★ | Turquoise         | 839.95 Set |
| 14379★ | Fawn              | 839.95 Set |
| 14380★ | Red               | 839.95 Set |

### 61 BEL-AIR 4-DR WAGON

| Part # | Color Combination | Price      |
|--------|-------------------|------------|
| 14387★ | Gray              | 899.95 Set |
| 14388★ | Green             | 899.95 Set |
| 14389★ | Blue              | 899.95 Set |
| 14390★ | Turquoise         | 899.95 Set |
| 14391★ | Fawn              | 899.95 Set |
| 14392★ | Red               | 899.95 Set |

### 61 IMPALA 2-DR HARDTOP

| Part # | Color Combination | Price      |
|--------|-------------------|------------|
| 14345★ | Red               | 869.95 Set |
| 14346★ | Fawn              | 869.95 Set |
| 14347★ | Blue              | 869.95 Set |
| 14348★ | Green             | 869.95 Set |
| 14349★ | Turquoise         | 869.95 Set |
| 14350★ | Gray              | 869.95 Set |

### 61 BEL-AIR 4-DR HARDTOP

| Part # | Color Combination | Price      |
|--------|-------------------|------------|
| 14381★ | Gray              | 899.95 Set |
| 14382★ | Green             | 899.95 Set |
| 14383★ | Blue              | 899.95 Set |
| 14384★ | Turquoise         | 899.95 Set |
| 14385★ | Fawn              | 899.95 Set |
| 14386★ | Red               | 899.95 Set |

### 61 BISCAYNE 2-DR SEDAN

| Part # | Color Combination | Price      |
|--------|-------------------|------------|
| 16452★ | Blue              | 839.95 Set |
| 16453★ | Green             | 839.95 Set |
| 16454★ | Gray/White        | 839.95 Set |

### 61 IMPALA 4-DR SEDAN

| Part # | Color Combination | Price      |
|--------|-------------------|------------|
| 14363★ | Gray              | 899.95 Set |
| 14364★ | Red               | 899.95 Set |
| 14365★ | Green             | 899.95 Set |
| 14366★ | Blue              | 899.95 Set |
| 14367★ | Fawn              | 899.95 Set |
| 14368★ | Turquoise         | 899.95 Set |

### 61 IMPALA 4-DR WAGON

| Part # | Color Combination | Price      |
|--------|-------------------|------------|
| 14369★ | Gray              | 899.95 Set |
| 14370★ | Red               | 899.95 Set |
| 14371★ | Green             | 899.95 Set |
| 14372★ | Blue              | 899.95 Set |
| 14373★ | Fawn              | 899.95 Set |
| 14374★ | Turquoise         | 899.95 Set |

## 1962 DOOR PANELS

Ready to install with your rails! Front and rear trim panels are assembled on new boards featuring correct grained vinyl and cloth materials. Set includes material to recover armrests, windlace, colored kick panels. Hardtop and Convertible models will have pre-sewn covers for the armrests. Before these can be built we will need the top rails out of your door panels. They need to be cleaned and painted ready to install.

### 62 IMPALA & SS CONVERTIBLE

| Part # | Color Combination | Price      |
|--------|-------------------|------------|
| 14393★ | Black             | 809.95 Set |
| 14394★ | Blue              | 809.95 Set |
| 14395★ | Turquoise         | 809.95 Set |
| 14396★ | Green             | 809.95 Set |
| 14397★ | Gold              | 809.95 Set |
| 14398★ | Red               | 809.95 Set |
| 14399★ | Fawn              | 809.95 Set |
| 11042★ | White             | 809.95 Set |

### 62 IMPALA & SS 2-DR HARDTOP

| Part # | Color Combination | Price      |
|--------|-------------------|------------|
| 14400★ | Fawn              | 809.95 Set |
| 14401★ | Blue              | 809.95 Set |
| 14402★ | Turquoise         | 809.95 Set |
| 14403★ | Green             | 809.95 Set |
| 14404★ | Gold              | 809.95 Set |
| 14405★ | Red               | 809.95 Set |
| 14406★ | Black             | 809.95 Set |
| 11041★ | White             | 809.95 Set |

### 62 IMPALA 4-DR HARDTOP

| Part # | Color Combination | Price      |
|--------|-------------------|------------|
| 14407★ | Fawn              | 839.95 Set |
| 14408★ | Blue              | 839.95 Set |
| 14409★ | Turquoise         | 839.95 Set |
| 14410★ | Green             | 839.95 Set |
| 14411★ | Gold              | 839.95 Set |
| 14412★ | Red               | 839.95 Set |

★ = special order non-stocking item, please allow 4-6 weeks for delivery.

Interiors CANNOT be returned!

# Interior

## 1962 DOOR PANELS-CONTINUED

Ready to install with your rails! Front and rear trim panels are assembled on new boards featuring correct grained vinyl and cloth materials. Set includes material to recover armrests, windlace, colored kick panels. Hardtop and Convertible models will have pre-sewn covers for the armrests. Before these can be built we will need the top rails out of your door panels. They need to be cleaned and painted ready to install.

### 62 IMPALA 4-DR SEDAN

| Part # | Color Combination | Price      |
|--------|-------------------|------------|
| 14413★ | Fawn              | 839.95 Set |
| 14414★ | Blue              | 839.95 Set |
| 14415★ | Turquoise         | 839.95 Set |
| 14416★ | Green             | 839.95 Set |
| 14417★ | Gold              | 839.95 Set |
| 14418★ | Red               | 839.95 Set |

### 62 BEL-AIR 2-DR SEDAN

| Part # | Color Combination | Price      |
|--------|-------------------|------------|
| 14430★ | Red               | 839.95 Set |
| 14431★ | Blue              | 839.95 Set |
| 14432★ | Turquoise         | 839.95 Set |
| 14433★ | Green             | 839.95 Set |
| 14434★ | Fawn              | 839.95 Set |

### 62 BISCAYNE 2-DR SEDAN

| Part # | Color Combination | Price      |
|--------|-------------------|------------|
| 14445★ | Red               | 839.95 Set |
| 14446★ | Turquoise         | 839.95 Set |
| 14447★ | Fawn              | 839.95 Set |

### 62 IMPALA 4-DR WAGON

| Part # | Color Combination | Price      |
|--------|-------------------|------------|
| 14419★ | Fawn              | 839.95 Set |
| 14420★ | Blue              | 839.95 Set |
| 14421★ | Turquoise         | 839.95 Set |
| 14422★ | Green             | 839.95 Set |
| 14423★ | Gold              | 839.95 Set |
| 14424★ | Red               | 839.95 Set |

### 62 BEL-AIR 4-DR SEDAN

| Part # | Color Combination | Price      |
|--------|-------------------|------------|
| 14435★ | Red               | 899.95 Set |
| 14436★ | Blue              | 899.95 Set |
| 14437★ | Turquoise         | 899.95 Set |
| 14438★ | Green             | 899.95 Set |
| 14439★ | Fawn              | 899.95 Set |

### 62 BISCAYNE 4-DR SEDAN

| Part # | Color Combination | Price      |
|--------|-------------------|------------|
| 14448★ | Red               | 899.95 Set |
| 14449★ | Turquoise         | 899.95 Set |
| 14450★ | Fawn              | 899.95 Set |

### 62 BEL-AIR 2-DR HARDTOP

| Part # | Color Combination | Price      |
|--------|-------------------|------------|
| 14425★ | Red               | 839.95 Set |
| 14426★ | Blue              | 839.95 Set |
| 14427★ | Turquoise         | 839.95 Set |
| 14428★ | Green             | 839.95 Set |
| 14429★ | Fawn              | 839.95 Set |

### 62 BEL-AIR 4-DR WAGON

| Part # | Color Combination | Price      |
|--------|-------------------|------------|
| 14440★ | Fawn              | 899.95 Set |
| 14441★ | Blue              | 899.95 Set |
| 14442★ | Turquoise         | 899.95 Set |
| 14443★ | Green             | 899.95 Set |
| 14444★ | Red               | 899.95 Set |

## 1963 DOOR PANELS

Ready to install with your rails! Front and rear trim panels are assembled on new boards featuring correct grained vinyl and cloth materials. Set includes material to recover armrests, windlace, colored kick panels. Hardtop and Convertible models will have pre-sewn covers for the rear armrests. To build these items, we will need your top rails out of your door and quarter panel boards. They need to be cleaned and painted ready to install.

### 63 IMPALA & SS CONVERTIBLE

| Part # | Color Combination | Price      |
|--------|-------------------|------------|
| 14451★ | Fawn              | 799.95 Set |
| 14452★ | Turquoise         | 799.95 Set |
| 14453★ | Red               | 799.95 Set |
| 14454★ | Blue              | 799.95 Set |
| 14455★ | Saddle            | 799.95 Set |
| 14456★ | Black             | 799.95 Set |
| 11044★ | White             | 799.95 Set |

### 63 BEL-AIR 2-DR SEDAN

| Part # | Color Combination | Price      |
|--------|-------------------|------------|
| 14486★ | Turquoise         | 839.95 Set |
| 14487★ | Fawn              | 839.95 Set |
| 14488★ | Blue              | 839.95 Set |
| 14489★ | Red               | 839.95 Set |
| 14490★ | Green             | 839.95 Set |

### 63 IMPALA & SS 2-DR HARDTOP

| Part # | Color Combination | Price      |
|--------|-------------------|------------|
| 14458★ | Fawn              | 799.95 Set |
| 14459★ | Turquoise         | 799.95 Set |
| 14460★ | Red               | 799.95 Set |
| 14461★ | Blue              | 799.95 Set |
| 14462★ | Saddle            | 799.95 Set |
| 14463★ | Black             | 799.95 Set |
| 11043★ | White             | 799.95 Set |

### 63 BISCAYNE 4-DR SEDAN

| Part # | Color Combination | Price      |
|--------|-------------------|------------|
| 14504★ | Red               | 879.95 Set |
| 14505★ | Fawn              | 879.95 Set |
| 14506★ | Turquoise         | 879.95 Set |

### 63 IMPALA 4-DR HARDTOP

| Part # | Color Combination | Price      |
|--------|-------------------|------------|
| 14465★ | Fawn              | 869.95 Set |
| 14466★ | Turquoise         | 869.95 Set |
| 14467★ | Red               | 869.95 Set |
| 14468★ | Blue              | 869.95 Set |
| 14469★ | Saddle            | 869.95 Set |
| 14470★ | Black             | 869.95 Set |
| 14471★ | Green             | 869.95 Set |

### 63 BISCAYNE 2-DR SEDAN

| Part # | Color Combination | Price      |
|--------|-------------------|------------|
| 14501★ | Red               | 839.95 Set |
| 14502★ | Fawn              | 839.95 Set |
| 14503★ | Turquoise         | 839.95 Set |

★ = special order non-stocking item, please allow 4-6 weeks for delivery.

Interiors CANNOT be returned!

# Interior

## 1963 DOOR PANELS-CONTINUED

Ready to install with your rails! Front and rear trim panels are assembled on new boards featuring correct grained vinyl and cloth materials. Set includes material to recover armrests, windlace, colored kick panels. Hardtop and Convertible models will have presewn covers for the rear armrests. To build these items, we will need your top rails out of your door and quarter panel boards. They need to be cleaned and painted ready to install.

### 63 BEL-AIR 4-DR WAGON

| Part # | Color Combination | Price      |
|--------|-------------------|------------|
| 14496★ | Fawn              | 899.95 Set |
| 14497★ | Turquoise         | 899.95 Set |
| 14498★ | Red               | 899.95 Set |
| 14499★ | Blue              | 899.95 Set |
| 14500★ | Green             | 899.95 Set |

### 63 BEL-AIR 4-DR SEDAN

| Part # | Color Combination | Price      |
|--------|-------------------|------------|
| 14491★ | Turquoise         | 879.95 Set |
| 14492★ | Fawn              | 879.95 Set |
| 14493★ | Blue              | 879.95 Set |
| 14494★ | Red               | 879.95 Set |
| 14495★ | Green             | 879.95 Set |

### 63 IMPALA 4-DR SEDAN

| Part # | Color Combination | Price      |
|--------|-------------------|------------|
| 14472★ | Fawn              | 869.95 Set |
| 14473★ | Turquoise         | 869.95 Set |
| 14474★ | Red               | 869.95 Set |
| 14475★ | Blue              | 869.95 Set |
| 14476★ | Green             | 869.95 Set |
| 14477★ | Black             | 869.95 Set |
| 14478★ | Saddle            | 869.95 Set |

### 63 IMPALA 4-DR WAGON

| Part # | Color Combination | Price      |
|--------|-------------------|------------|
| 14479★ | Blue              | 869.95 Set |
| 14480★ | Turquoise         | 869.95 Set |
| 14481★ | Green             | 869.95 Set |
| 14482★ | Saddle            | 869.95 Set |
| 14483★ | Red               | 869.95 Set |
| 14484★ | Black             | 869.95 Set |
| 14485★ | Fawn              | 869.95 Set |

## 1964 DOOR PANELS

Ready to install with your rails! Front and rear trim panels are assembled on new boards featuring correct grained vinyl and cloth materials. Set includes material to recover armrests, windlace, colored kick panels. Hardtop and Convertible models will have presewn covers for the rear armrests. To build these items, we will need your top rails out of your door and quarter panel boards. They need to be cleaned and painted ready to install.

### 64 IMPALA CONVERTIBLE

| Part # | Color Combination | Price      |
|--------|-------------------|------------|
| 14517★ | Red               | 799.95 Set |
| 14518★ | Fawn              | 799.95 Set |
| 14519★ | Turquoise         | 799.95 Set |
| 14520★ | Red               | 799.95 Set |
| 14521★ | Fawn              | 799.95 Set |
| 14522★ | Turquoise         | 799.95 Set |

### 64 IMPALA 4-DR WAGON

| Part # | Color Combination | Price      |
|--------|-------------------|------------|
| 14555★ | Red               | 869.95 Set |
| 14556★ | Blue              | 869.95 Set |
| 14557★ | Saddle            | 869.95 Set |
| 14558★ | Black             | 869.95 Set |
| 14559★ | Oyster            | 869.95 Set |
| 14560★ | Turquoise         | 869.95 Set |
| 14561★ | Green             | 869.95 Set |

### 64 IMPALA SS CONVERTIBLE

| Part # | Color Combination | Price      |
|--------|-------------------|------------|
| 14507★ | Red               | 799.95 Set |
| 14508★ | Blue              | 799.95 Set |
| 14509★ | Saddle            | 799.95 Set |
| 14510★ | Black             | 799.95 Set |
| 14511★ | Oyster            | 799.95 Set |
| 14512★ | White/Turquoise   | 799.95 Set |
| 14513★ | White/Red         | 799.95 Set |
| 14515★ | Silver/Black      | 799.95 Set |
| 14516★ | White/Black       | 799.95 Set |
| 11046★ | White             | 799.95 Set |

### 64 IMPALA 4-DR HARDTOP

| Part # | Color Combination | Price      |
|--------|-------------------|------------|
| 14541★ | Red               | 869.95 Set |
| 14542★ | Blue              | 869.95 Set |
| 14543★ | Saddle            | 869.95 Set |
| 14544★ | Black             | 869.95 Set |
| 14545★ | Oyster            | 869.95 Set |
| 14546★ | Turquoise         | 869.95 Set |
| 14547★ | Green             | 869.95 Set |

### 64 IMPALA SS 2-DR HARDTOP

| Part # | Color Combination | Price      |
|--------|-------------------|------------|
| 14524★ | Red               | 799.95 Set |
| 14525★ | Blue              | 799.95 Set |
| 14526★ | Saddle            | 799.95 Set |
| 14527★ | Black             | 799.95 Set |
| 14528★ | Oyster            | 799.95 Set |
| 14529★ | White/Turquoise   | 799.95 Set |
| 14530★ | White/Red         | 799.95 Set |
| 14532★ | Silver/Black      | 799.95 Set |
| 14533★ | White/Black       | 799.95 Set |
| 11045★ | White             | 799.95 Set |

### 64 IMPALA 2-DR HARDTOP

| Part # | Color Combination | Price      |
|--------|-------------------|------------|
| 14534★ | Red               | 799.95 Set |
| 14535★ | Blue              | 799.95 Set |
| 14536★ | Saddle            | 799.95 Set |
| 14537★ | Black             | 799.95 Set |
| 14538★ | Oyster            | 799.95 Set |
| 14539★ | Turquoise         | 799.95 Set |

★ = special order non-stocking item, please allow 4-6 weeks for delivery.

Interiors CANNOT be returned!

# Interior

## 1964 DOOR PANELS-CONTINUED

Ready to install with your rails! Front and rear trim panels are assembled on new boards featuring correct grained vinyl and cloth materials. Set includes material to recover armrests, windlace, colored kick panels. Hardtop and Convertible models will have pre-sewn covers for the rear armrests. To build these items, we will need your top rails out of your door and quarter panel boards. They need to be cleaned and painted ready to install.

### 64 IMPALA 4-DR SEDAN

| Part # | Color Combination | Price      |
|--------|-------------------|------------|
| 14548★ | Red               | 869.95 Set |
| 14549★ | Blue              | 869.95 Set |
| 14550★ | Saddle            | 869.95 Set |
| 14551★ | Black             | 869.95 Set |
| 14552★ | Oyster            | 869.95 Set |
| 14553★ | Turquoise         | 869.95 Set |
| 14554★ | Green             | 869.95 Set |

### 64 BISCAYNE 2-DR SEDAN

| Part # | Color Combination | Price      |
|--------|-------------------|------------|
| 14577★ | Red               | 829.95 Set |
| 14578★ | Oyster            | 829.95 Set |
| 14579★ | Turquoise         | 829.95 Set |

### 64 BEL-AIR 2-DR SEDAN

| Part # | Color Combination | Price      |
|--------|-------------------|------------|
| 14562★ | Blue              | 829.95 Set |
| 14563★ | Turquoise         | 829.95 Set |
| 14564★ | Red               | 829.95 Set |
| 14565★ | Green             | 829.95 Set |
| 14566★ | Oyster            | 829.95 Set |

### 64 BISCAYNE 4-DR SEDAN

| Part # | Color Combination | Price      |
|--------|-------------------|------------|
| 14580★ | Red               | 829.95 Set |
| 14581★ | Oyster            | 829.95 Set |
| 14582★ | Turquoise         | 829.95 Set |

### 64 BEL-AIR 4-DR SEDAN

| Part # | Color Combination | Price      |
|--------|-------------------|------------|
| 14567★ | Blue              | 829.95 Set |
| 14568★ | Turquoise         | 829.95 Set |
| 14569★ | Red               | 829.95 Set |
| 14570★ | Green             | 829.95 Set |
| 14571★ | Oyster            | 829.95 Set |

### 64 BEL-AIR 4-DR WAGON

| Part # | Color Combination | Price      |
|--------|-------------------|------------|
| 14572★ | Red               | 829.95 Set |
| 14573★ | Oyster            | 829.95 Set |
| 14574★ | Turquoise         | 829.95 Set |
| 14575★ | Green             | 829.95 Set |
| 14576★ | Blue              | 829.95 Set |

## 1965 DOOR PANELS

Ready to install with your rails! Front and rear trim panels are assembled on new boards featuring correct grained vinyl and cloth materials. Set includes material to recover armrests, windlace, colored kick panels. Hardtop and Convertible models will have pre-sewn covers for the armrests. Two door Hardtop and Convertible Models also come installed on new top rails. Four door Hardtop, Sedans, and Wagons these can be built when we have your top rails out of your door panels. They need to be cleaned and painted ready to install.

### 65 IMPALA SS CONVERTIBLE

| Part # | Color Combination | Price      |
|--------|-------------------|------------|
| 14583★ | Slate             | 799.95 Set |
| 14584★ | Black             | 799.95 Set |
| 14585★ | Red               | 799.95 Set |
| 14586★ | White/Black       | 799.95 Set |
| 14587★ | Blue              | 799.95 Set |
| 14588★ | Saddle            | 799.95 Set |
| 14589★ | Fawn              | 799.95 Set |
| 14590★ | White/Turquoise   | 799.95 Set |
| 14591★ | White/Red         | 799.95 Set |

### 65 BISCAYNE 2-DR SEDAN

| Part # | Color Combination | Price      |
|--------|-------------------|------------|
| 16461★ | Fawn              | 849.95 Set |
| 16462★ | Turquoise         | 849.95 Set |
| 16463★ | Red               | 849.95 Set |

### 65 BISCAYNE 4-DR SEDAN

| Part # | Color Combination | Price      |
|--------|-------------------|------------|
| 16464★ | Fawn              | 849.95 Set |
| 16465★ | Turquoise         | 849.95 Set |
| 16466★ | Red               | 849.95 Set |

### 65 IMPALA CONVERTIBLE

| Part # | Color Combination | Price      |
|--------|-------------------|------------|
| 14592★ | Red               | 799.95 Set |
| 14593★ | Light Blue        | 799.95 Set |
| 14594★ | Black             | 799.95 Set |
| 14595★ | Fawn              | 799.95 Set |
| 14596★ | Turquoise         | 799.95 Set |
| 14597★ | Saddle            | 799.95 Set |

### 65 IMPALA 2-DR HARDTOP

| Part # | Color Combination | Price      |
|--------|-------------------|------------|
| 14608★ | Red               | 799.95 Set |
| 14609★ | Light Blue        | 799.95 Set |
| 14610★ | Black             | 799.95 Set |
| 14611★ | Fawn              | 799.95 Set |
| 14612★ | Turquoise         | 799.95 Set |
| 14613★ | Saddle            | 799.95 Set |

### 65 BEL-AIR 2-DR SEDAN

| Part # | Color Combination | Price      |
|--------|-------------------|------------|
| 15986★ | Red               | 849.95 Set |
| 15987★ | Blue              | 849.95 Set |
| 15988★ | Green             | 849.95 Set |
| 15989★ | Turquoise         | 849.95 Set |
| 15990★ | Fawn              | 849.95 Set |

### 65 IMPALA SS 2-DR HARDTOP

| Part # | Color Combination | Price      |
|--------|-------------------|------------|
| 14599★ | Slate             | 799.95 Set |
| 14600★ | Black             | 799.95 Set |
| 14601★ | Red               | 799.95 Set |
| 14602★ | White/Black       | 799.95 Set |
| 14603★ | Blue              | 799.95 Set |
| 14604★ | Saddle            | 799.95 Set |
| 14605★ | Fawn              | 799.95 Set |
| 14606★ | White/Turquoise   | 799.95 Set |
| 14607★ | White/Red         | 799.95 Set |

### 65 IMPALA 4-DR WAGON

| Part # | Color Combination | Price      |
|--------|-------------------|------------|
| 16455★ | Saddle            | 849.95 Set |
| 16456★ | Turquoise         | 849.95 Set |
| 16457★ | Fawn              | 849.95 Set |
| 16458★ | Red               | 849.95 Set |
| 16459★ | Light Blue        | 849.95 Set |
| 16460★ | Gray              | 849.95 Set |

★ = special order non-stocking item, please allow 4-6 weeks for delivery.

Interiors CANNOT be returned!

# Interior

## 1966 DOOR PANELS

Ready to install with your rails! Front and rear trim panels are assembled on new boards featuring correct grained vinyl and cloth materials. Set includes material to recover armrests, windlace, colored kick panels. Hardtop and Convertible models will have pre-sewn covers for the armrests. Two door Hardtop and Convertible Models also come installed on new top rails. Four door Hardtop, Sedans, and Wagons these can be built when we have your top rails out of your door panels. They need to be cleaned and painted ready to install.

### 66 IMPALA SS CONVERTIBLE

| Part # | Color Combination | Price      |
|--------|-------------------|------------|
| 14616★ | Black             | 559.95 Set |
| 14617★ | White             | 559.95 Set |
| 14618★ | Red               | 559.95 Set |
| 14619★ | Bright Blue       | 559.95 Set |
| 14620★ | Blue              | 559.95 Set |
| 14621★ | Turquoise         | 559.95 Set |
| 14622★ | Fawn              | 559.95 Set |

### 66 IMPALA CONVERTIBLE

| Part # | Color Combination | Price      |
|--------|-------------------|------------|
| 14616★ | Black             | 559.95 Set |
| 14617★ | White             | 559.95 Set |
| 14618★ | Red               | 559.95 Set |
| 14620★ | Blue              | 559.95 Set |
| 14621★ | Turquoise         | 559.95 Set |
| 14622★ | Fawn              | 559.95 Set |

### 66 IMPALA SS 2-DR HARDTOP

| Part # | Color Combination | Price      |
|--------|-------------------|------------|
| 14624★ | Black             | 559.95 Set |
| 14625★ | White             | 559.95 Set |
| 14626★ | Red               | 559.95 Set |
| 14627★ | Bright Blue       | 559.95 Set |
| 14628★ | Blue              | 559.95 Set |
| 14629★ | Turquoise         | 559.95 Set |
| 14630★ | Fawn              | 559.95 Set |

### 66 IMPALA 2-DR HARDTOP

| Part # | Color Combination | Price      |
|--------|-------------------|------------|
| 14624★ | Black             | 559.95 Set |
| 14625★ | White             | 559.95 Set |
| 14626★ | Red               | 559.95 Set |
| 14628★ | Blue              | 559.95 Set |
| 14629★ | Turquoise         | 559.95 Set |
| 14630★ | Fawn              | 559.95 Set |

### 66 IMPALA 4-DR SEDAN

| Part # | Color Combination | Price      |
|--------|-------------------|------------|
| 16473★ | Black             | 869.95 Set |
| 16474★ | Red               | 869.95 Set |
| 16475★ | Fawn              | 869.95 Set |
| 16476★ | Turquoise         | 869.95 Set |
| 16477★ | Blue              | 869.95 Set |
| 16478★ | Green             | 869.95 Set |

### 66 IMPALA 4-DR HARDTOP

| Part # | Color Combination | Price      |
|--------|-------------------|------------|
| 16467★ | Black             | 869.95 Set |
| 16468★ | Red               | 869.95 Set |
| 16469★ | Fawn              | 869.95 Set |
| 16470★ | Turquoise         | 869.95 Set |
| 16471★ | Blue              | 869.95 Set |
| 16472★ | Green             | 869.95 Set |

### 66 BISCAYNE 2-DR SEDAN

| Part # | Color Combination | Price      |
|--------|-------------------|------------|
| 14631★ | Blue              | 849.95 Set |
| 14632★ | Fawn              | 849.95 Set |
| 14633★ | Red               | 849.95 Set |

### 66 BISCAYNE 4-DR SEDAN

| Part # | Color Combination | Price      |
|--------|-------------------|------------|
| 16479★ | Black             | 849.95 Set |
| 16480★ | Fawn              | 849.95 Set |
| 16481★ | Red               | 849.95 Set |

## 1967 DOOR PANELS

Ready to install with your rails! Front and rear trim panels are assembled on new boards featuring correct grained vinyl and cloth materials. Set includes material to recover armrests, windlace, colored kick panels. Hardtop and Convertible models will have pre-sewn covers for the armrests. Two door Hardtop and Convertible Models also come installed on new top rails. Four door Hardtop, Sedans, and Wagons these can be built when we have your top rails out of your door panels. They need to be cleaned and painted ready to install.

### 67 IMPALA 2-DR HARDTOP

| Part # | Color Combination | Price      |
|--------|-------------------|------------|
| 14641★ | Black             | 729.95 Set |
| 14642★ | Red               | 729.95 Set |
| 14643★ | Bright Blue       | 729.95 Set |
| 14644★ | Light Blue        | 729.95 Set |
| 15099★ | Turquoise         | 729.95 Set |
| 14645★ | Gold              | 729.95 Set |
| 14646★ | Off White         | 729.95 Set |

### 67 IMPALA CONVERTIBLE

| Part # | Color Combination | Price      |
|--------|-------------------|------------|
| 14634★ | Black             | 699.95 Set |
| 14635★ | Red               | 699.95 Set |
| 14636★ | Bright Blue       | 699.95 Set |
| 14637★ | Light Blue        | 699.95 Set |
| 14638★ | Turquoise         | 699.95 Set |
| 14639★ | Gold              | 699.95 Set |
| 14640★ | Off White         | 699.95 Set |

### 67 IMPALA SS CONVERTIBLE

| Part # | Color Combination | Price      |
|--------|-------------------|------------|
| 14634★ | Black             | 699.95 Set |
| 14635★ | Red               | 699.95 Set |
| 14636★ | Bright Blue       | 699.95 Set |
| 14639★ | Gold              | 699.95 Set |
| 14640★ | Off White         | 699.95 Set |

### 67 IMPALA SS 2-DR HARDTOP

| Part # | Color Combination | Price      |
|--------|-------------------|------------|
| 14641★ | Black             | 729.95 Set |
| 14642★ | Red               | 729.95 Set |
| 14643★ | Bright Blue       | 729.95 Set |
| 14645★ | Gold              | 729.95 Set |
| 14646★ | Off White         | 729.95 Set |

★ = special order non-stocking item, please allow 4-6 weeks for delivery.

Interiors CANNOT be returned!

# Interior

## 1968 DOOR PANELS

Ready to install with your rails! Front and rear trim panels are assembled on new boards featuring correct grained vinyl and cloth materials. Set includes material to recover armrests, windlace, colored kick panels. Hardtop and Convertible models will have pre-sewn covers for the armrests. Two door Hardtop and Convertible Models also come installed on new top rails. Four door Hardtop, Sedans, and Wagons these can be built when we have your top rails out of your door panels. They need to be cleaned and painted ready to install.

### 68 IMPALA & SS CONVERTIBLE

| Part # | Color Combination | Price      |
|--------|-------------------|------------|
| 14647★ | Black             | 699.95 Set |
| 14648★ | Parchment         | 699.95 Set |
| 14649★ | Red               | 699.95 Set |
| 14650★ | Medium Blue       | 699.95 Set |
| 14651★ | Ivory/Gold        | 699.95 Set |
| 11049★ | Turquoise         | 779.95 Set |
| 12075★ | Light Blue        | 779.95 Set |

### 68 IMPALA & SS 2-DR HARDTOP

| Part # | Color Combination | Price      |
|--------|-------------------|------------|
| 14652★ | Black             | 699.95 Set |
| 14653★ | Parchment         | 699.95 Set |
| 14654★ | Red               | 699.95 Set |
| 14655★ | Medium Blue       | 699.95 Set |
| 14656★ | Ivory/Gold        | 699.95 Set |
| 11047★ | Turquoise         | 779.95 Set |
| 11048★ | Light Blue        | 779.95 Set |

### 68 IMPALA 4-DR HARDTOP

| Part #       | Color Combination | Price      |
|--------------|-------------------|------------|
| <b>Front</b> |                   |            |
| 16152★       | Light Aqua        | 429.95 Set |
| 16153★       | Blue              | 429.95 Set |
| 16154★       | Ivory / Gold      | 429.95 Set |
| 16155★       | Black             | 429.95 Set |
| 16156★       | Pearl             | 429.95 Set |
| 16157★       | Light Blue        | 429.95 Set |
| 16158★       | Red               | 429.95 Set |
| <b>Rear</b>  |                   |            |
| 16159★       | Light Aqua        | 429.95 Set |
| 16160★       | Blue              | 429.95 Set |
| 16161★       | Ivory / Gold      | 429.95 Set |
| 16162★       | Black             | 429.95 Set |
| 16163★       | Pearl             | 429.95 Set |
| 16164★       | Light Blue        | 429.95 Set |
| 16165★       | Red               | 429.95 Set |

## 1969 DOOR PANELS

Ready to install with your rails! Front and rear trim panels are assembled on new boards featuring correct grained vinyl and cloth materials. Set includes material to recover armrests, windlace, colored kick panels. Hardtop and Convertible models will have pre-sewn covers for the armrests. Two door Hardtop and Convertible Models also come installed on new top rails. Four door Hardtop, Sedans, and Wagons these can be built when we have your top rails out of your door panels. They need to be cleaned and painted ready to install.

### 69 IMPALA CONVERTIBLE

| Part # | Color Combination | Price      |
|--------|-------------------|------------|
| 15355★ | Black             | 459.95 Set |
| 15356★ | Ivy Green         | 459.95 Set |
| 15357★ | Parchment         | 459.95 Set |
| 15358★ | Red               | 459.95 Set |

### 69 IMPALA 2-DR HARDTOP

| Part # | Color Combination | Price      |
|--------|-------------------|------------|
| 12076★ | Black             | 779.95 Set |
| 12077★ | Dark Green        | 779.95 Set |
| 12078★ | Ivy Green         | 779.95 Set |
| 12079★ | Parchment         | 779.95 Set |
| 12080★ | Red               | 779.95 Set |
| 15354★ | Dark Blue         | 479.95 Set |

★ = special order non-stocking item, please allow 4-6 weeks for delivery.

Interiors CANNOT be returned!

# Interior

## 1958 HEADLINERS

Headliners come presewn ready to install with material included to re-cover the sunvisors. Correct Vinyl or Cloth is used.

| 58 IMPALA 2-DR HARDTOP |                   |            |
|------------------------|-------------------|------------|
| Part #                 | Color Combination | Price      |
| 14657★                 | Silver            | 169.95 Ea. |
| 14658★                 | Beige             | 169.95 Ea. |
| 14659★                 | Silver Blue       | 169.95 Ea. |
| 14660★                 | Green             | 169.95 Ea. |
| 14661★                 | Turquoise         | 169.95 Ea. |
| 15359★                 | Coral             | 169.95 Ea. |

| 58 BEL-AIR 2/4-DR HARDTOP |                   |            |
|---------------------------|-------------------|------------|
| Part #                    | Color Combination | Price      |
| 14662★                    | Silver            | 169.95 Ea. |
| 14663★                    | Green             | 169.95 Ea. |
| 14664★                    | Blue              | 169.95 Ea. |
| 14665★                    | Turquoise         | 169.95 Ea. |
| 14666★                    | Beige             | 169.95 Ea. |
| 14667★                    | Coral             | 169.95 Ea. |

| 58 BEL-AIR SEDAN |                   |            |
|------------------|-------------------|------------|
| Part #           | Color Combination | Price      |
| 14668★           | Gold              | 169.95 Ea. |
| 14669★           | Gray              | 169.95 Ea. |
| 14670★           | Turquoise         | 169.95 Ea. |
| 1f★              | Blue              | 169.95 Ea. |
| 14672★           | Beige             | 169.95 Ea. |
| 14673★           | Green             | 169.95 Ea. |
| 15360★           | Coral             | 169.95 Ea. |

| 58 NOMAD WAGON |                   |            |
|----------------|-------------------|------------|
| Part #         | Color Combination | Price      |
| 14674★         | Silver            | 189.95 Ea. |
| 14675★         | Green             | 189.95 Ea. |
| 14676★         | Blue              | 189.95 Ea. |
| 14677★         | Turquoise         | 189.95 Ea. |
| 14678★         | Beige             | 189.95 Ea. |
| 14679★         | Coral             | 189.95 Ea. |

## 1959 HEADLINERS

Headliners come presewn ready to install with material included to re-cover the sunvisors. Correct Vinyl or Cloth is used.

| 59 IMPALA 2-DR HARDTOP |                   |            |
|------------------------|-------------------|------------|
| Part #                 | Color Combination | Price      |
| 14680★                 | Blue              | 169.95 Ea. |
| 14681★                 | Green             | 169.95 Ea. |
| 14682★                 | Copper            | 169.95 Ea. |
| 14683★                 | Turquoise         | 169.95 Ea. |
| 14684★                 | Sliver            | 169.95 Ea. |
| 14685★                 | White             | 169.95 Ea. |

| 59 IMPALA 4-DR HARDTOP |                   |            |
|------------------------|-------------------|------------|
| Part #                 | Color Combination | Price      |
| 14686★                 | Blue              | 169.95 Ea. |
| 14687★                 | Green             | 169.95 Ea. |
| 14688★                 | Copper            | 169.95 Ea. |
| 14689★                 | Turquoise         | 169.95 Ea. |
| 14690★                 | Sliver            | 169.95 Ea. |

| 59 IMPALA 4-DR SEDAN |                   |            |
|----------------------|-------------------|------------|
| Part #               | Color Combination | Price      |
| 14691★               | Gray              | 169.95 Ea. |
| 14692★               | Blue              | 169.95 Ea. |
| 14693★               | Turquoise         | 169.95 Ea. |
| 14694★               | Green             | 169.95 Ea. |
| 14695★               | Copper            | 169.95 Ea. |

| 59 IMPALA WAGON |                   |            |
|-----------------|-------------------|------------|
| Part #          | Color Combination | Price      |
| 15361★          | Silver            | 189.95 Ea. |
| 15362★          | Blue              | 189.95 Ea. |
| 15363★          | Turquoise         | 189.95 Ea. |
| 15364★          | Green             | 189.95 Ea. |
| 15365★          | Copper            | 189.95 Ea. |
| 15366★          | White             | 189.95 Ea. |

| 59 EL CAMINO |                   |            |
|--------------|-------------------|------------|
| Part #       | Color Combination | Price      |
| 15372★       | Copper            | 169.95 Ea. |
| 15373★       | Blue              | 169.95 Ea. |
| 15374★       | Silver            | 169.95 Ea. |
| 15375★       | Green             | 169.95 Ea. |
| 15376★       | Turquoise         | 169.95 Ea. |

## 1960 HEADLINERS

Headliners come presewn ready to install with material included to re-cover the sunvisors. Correct Vinyl or Cloth is used.

| 60 IMPALA 2-DR HARDTOP |                   |            |
|------------------------|-------------------|------------|
| Part #                 | Color Combination | Price      |
| 14680★                 | Blue              | 169.95 Ea. |
| 14681★                 | Green             | 169.95 Ea. |
| 14682★                 | Cooper            | 169.95 Ea. |
| 14683★                 | Turquoise         | 169.95 Ea. |
| 14685★                 | White             | 169.95 Ea. |

| 60 IMPALA 4-DR HARDTOP |                   |            |
|------------------------|-------------------|------------|
| Part #                 | Color Combination | Price      |
| 14696★                 | Green             | 169.95 Ea. |
| 14697★                 | Copper            | 169.95 Ea. |
| 14698★                 | Blue              | 169.95 Ea. |
| 14699★                 | Turquoise         | 169.95 Ea. |
| 14700★                 | White             | 169.95 Ea. |

★ = special order non-stocking item, please allow 4-6 weeks for delivery.

Interiors CANNOT be returned!

# Interior

## 1960 HEADLINERS-CONTINUED

Headliners come pre-sewn ready to install with material included to re-cover the sunvisors. Correct Vinyl or Cloth is used.

| 60 IMPALA SEDAN |                   |            |
|-----------------|-------------------|------------|
| Part #          | Color Combination | Price      |
| 14691★          | Gray              | 169.95 Ea. |
| 14692★          | Blue              | 169.95 Ea. |
| 14693★          | Turquoise         | 169.95 Ea. |
| 14694★          | Green             | 169.95 Ea. |
| 14695★          | Copper            | 169.95 Ea. |
| 59 IMPALA WAGON |                   |            |
| Part #          | Color Combination | Price      |
| 15361★          | Silver            | 189.95 Ea. |
| 15362★          | Blue              | 189.95 Ea. |
| 15363★          | Turquoise         | 189.95 Ea. |
| 15364★          | Green             | 189.95 Ea. |
| 15365★          | Copper            | 189.95 Ea. |
| 15366★          | White             | 189.95 Ea. |

| 60 BEL-AIR 2-DR SEDAN |                   |            |
|-----------------------|-------------------|------------|
| Part #                | Color Combination | Price      |
| 14691★                | Gray              | 169.95 Ea. |
| 14692★                | Blue              | 169.95 Ea. |
| 14693★                | Turquoise         | 169.95 Ea. |
| 14694★                | Green             | 169.95 Ea. |
| 14695★                | Copper            | 169.95 Ea. |
| 59 EL CAMINO          |                   |            |
| Part #                | Color Combination | Price      |
| 15372★                | Copper            | 169.95 Ea. |
| 15373★                | Blue              | 169.95 Ea. |
| 15374★                | Silver            | 169.95 Ea. |
| 15375★                | Green             | 169.95 Ea. |
| 15376★                | Turquoise         | 169.95 Ea. |

| 60 BEL-AIR 2-DR HARDTOP |                   |            |
|-------------------------|-------------------|------------|
| Part #                  | Color Combination | Price      |
| 15367★                  | Gray              | 169.95 Ea. |
| 15368★                  | Light Green       | 169.95 Ea. |
| 15369★                  | Blue              | 169.95 Ea. |
| 15370★                  | Copper            | 169.95 Ea. |
| 15371★                  | Turquoise         | 169.95 Ea. |

## 1961 HEADLINERS

Headliners come pre-sewn ready to install with material included to re-cover the sunvisors. Correct Vinyl or Cloth is used.

| 61 IMPALA 2-DR HARDTOP |                   |            |
|------------------------|-------------------|------------|
| Part #                 | Color Combination | Price      |
| 14701★                 | Green             | 119.95 Ea. |
| 14702★                 | Beige             | 119.95 Ea. |
| 14703★                 | White             | 119.95 Ea. |
| 14704★                 | Turquoise         | 119.95 Ea. |
| 14705★                 | Blue              | 119.95 Ea. |
| 61 IMPALA 4-DR WAGON   |                   |            |
| Part #                 | Color Combination | Price      |
| 14716★                 | Gray              | 189.95 Ea. |
| 14717★                 | Green             | 189.95 Ea. |
| 14718★                 | Blue              | 189.95 Ea. |
| 14719★                 | Turquoise         | 189.95 Ea. |
| 14720★                 | Fawn              | 189.95 Ea. |
| 15377★                 | White             | 189.95 Ea. |
| 61 BEL-AIR WAGON       |                   |            |
| Part #                 | Color Combination | Price      |
| 14717★                 | Green             | 189.95 Ea. |
| 14718★                 | Blue              | 189.95 Ea. |
| 14719★                 | Turquoise         | 189.95 Ea. |
| 14720★                 | Fawn              | 189.95 Ea. |
| 15377★                 | White             | 189.95 Ea. |

| 61 IMPALA 4-DR HARDTOP  |                   |            |
|-------------------------|-------------------|------------|
| Part #                  | Color Combination | Price      |
| 14706★                  | Green             | 169.95 Ea. |
| 14707★                  | Beige             | 169.95 Ea. |
| 14708★                  | White             | 169.95 Ea. |
| 14709★                  | Turquoise         | 169.95 Ea. |
| 14710★                  | Blue              | 169.95 Ea. |
| 61 BEL-AIR 2-DR HARDTOP |                   |            |
| Part #                  | Color Combination | Price      |
| 14721★                  | White             | 189.95 Ea. |
| 14722★                  | Blue              | 189.95 Ea. |
| 14723★                  | Turquoise         | 189.95 Ea. |
| 14724★                  | Beige             | 189.95 Ea. |
| 14725★                  | Green             | 189.95 Ea. |

| 61 IMPALA SEDAN         |                   |            |
|-------------------------|-------------------|------------|
| Part #                  | Color Combination | Price      |
| 14711★                  | Gray              | 169.95 Ea. |
| 14712★                  | Green             | 169.95 Ea. |
| 14713★                  | Blue              | 169.95 Ea. |
| 14714★                  | Turquoise         | 169.95 Ea. |
| 14715★                  | Fawn              | 169.95 Ea. |
| 61 BEL-AIR 4-DR HARDTOP |                   |            |
| Part #                  | Color Combination | Price      |
| 14726★                  | White             | 169.95 Ea. |
| 14727★                  | Green             | 169.95 Ea. |
| 14728★                  | Blue              | 169.95 Ea. |
| 14729★                  | Turquoise         | 169.95 Ea. |
| 14730★                  | Fawn              | 169.95 Ea. |

★ = special order non-stocking item, please allow 4-6 weeks for delivery.

Interiors CANNOT be returned!

# Interior

## HEADLINER TRIM



| Part #  | Year  | Model          | Part               | Price      |
|---------|-------|----------------|--------------------|------------|
| 15691 ① | 62-64 | Impala Hardtop | Headliner Trim Set | 229.95 Set |

## 1962 HEADLINERS

Headliners come pre-sewn ready to install with material included to re-cover the sunvisors. Correct Vinyl or Cloth is used.

### 62 IMPALA & SS 2-DR HARDTOP

| Part # | Color Combination | Price      |
|--------|-------------------|------------|
| 14731★ | Fawn              | 139.95 Ea. |
| 14732★ | Blue              | 139.95 Ea. |
| 14733★ | Turquoise         | 139.95 Ea. |
| 14734★ | Green             | 139.95 Ea. |
| 14735★ | Gold              | 139.95 Ea. |
| 14736★ | White             | 139.95 Ea. |
| 14737★ | Black             | 139.95 Ea. |

### 62 BEL-AIR 2-DR HARDTOP

| Part # | Color Combination | Price      |
|--------|-------------------|------------|
| 14721★ | White             | 169.95 Ea. |
| 14722★ | Blue              | 169.95 Ea. |
| 14723★ | Turquoise         | 169.95 Ea. |
| 14724★ | Beige             | 169.95 Ea. |
| 14725★ | Green             | 169.95 Ea. |

### 62 BEL-AIR SEDAN

| Part # | Color Combination | Price      |
|--------|-------------------|------------|
| 14760★ | Gray              | 169.95 Ea. |
| 14761★ | Turquoise         | 169.95 Ea. |
| 14762★ | Blue              | 169.95 Ea. |
| 14763★ | Green             | 169.95 Ea. |
| 14764★ | Beige             | 169.95 Ea. |

### 62 IMPALA 4-DR HARDTOP

| Part # | Color Combination | Price      |
|--------|-------------------|------------|
| 14738★ | Fawn              | 169.95 Ea. |
| 14739★ | Blue              | 169.95 Ea. |
| 14740★ | Turquoise         | 169.95 Ea. |
| 14741★ | Green             | 169.95 Ea. |
| 14742★ | Gold              | 169.95 Ea. |
| 14743★ | White             | 169.95 Ea. |
| 14744★ | Black             | 169.95 Ea. |

### 62 IMPALA 4-DR WAGON

| Part # | Color Combination | Price      |
|--------|-------------------|------------|
| 14752★ | Fawn              | 189.95 Ea. |
| 14753★ | Blue              | 189.95 Ea. |
| 14754★ | Turquoise         | 189.95 Ea. |
| 14755★ | Green             | 189.95 Ea. |
| 14756★ | Gold              | 189.95 Ea. |
| 14757★ | White             | 189.95 Ea. |
| 14759★ | Black             | 189.95 Ea. |

### 62 IMPALA 4-DR SEDAN

| Part # | Color Combination | Price      |
|--------|-------------------|------------|
| 14745★ | Fawn              | 169.95 Ea. |
| 14746★ | Blue              | 169.95 Ea. |
| 14747★ | Turquoise         | 169.95 Ea. |
| 14748★ | Green             | 169.95 Ea. |
| 14749★ | Gold              | 169.95 Ea. |
| 14750★ | White             | 169.95 Ea. |
| 14751★ | Black             | 169.95 Ea. |

### 62 BEL-AIR WAGON

| Part # | Color Combination | Price      |
|--------|-------------------|------------|
| 14717★ | Green             | 189.95 Ea. |
| 14718★ | Blue              | 189.95 Ea. |
| 14719★ | Turquoise         | 189.95 Ea. |
| 14720★ | Fawn              | 189.95 Ea. |
| 15377★ | White             | 189.95 Ea. |

### 62 BISCAYNE 2/4-DR SEDAN

| Part # | Color Combination | Price      |
|--------|-------------------|------------|
| 14783★ | Fawn              | 169.95 Ea. |
| 14784★ | Blue              | 169.95 Ea. |
| 14785★ | Turquoise         | 169.95 Ea. |
| 14786★ | Green             | 169.95 Ea. |
| 14787★ | White             | 169.95 Ea. |

## 1963 HEADLINERS

Headliners come pre-sewn ready to install with material included to re-cover the sunvisors. Correct Vinyl or Cloth is used.

### 63 BEL-AIR/BISCAYNE SEDAN

| Part # | Color Combination | Price      |
|--------|-------------------|------------|
| 14776★ | Turquoise         | 169.95 Ea. |
| 14777★ | White             | 169.95 Ea. |
| 14778★ | Green             | 169.95 Ea. |
| 14779★ | Fawn              | 169.95 Ea. |
| 14780★ | Blue              | 169.95 Ea. |

### 63 IMPALA 4-DR SEDAN

| Part # | Color Combination | Price      |
|--------|-------------------|------------|
| 14745★ | Fawn              | 169.95 Ea. |
| 14746★ | Blue              | 169.95 Ea. |
| 14747★ | Turquoise         | 169.95 Ea. |
| 14748★ | Green             | 169.95 Ea. |
| 14750★ | White             | 169.95 Ea. |
| 14773★ | Saddle            | 169.95 Ea. |
| 14751★ | Black             | 169.95 Ea. |
| 14774★ | Red               | 169.95 Ea. |

### 63 IMPALA & SS 2-DR HARDTOP

| Part # | Color Combination | Price      |
|--------|-------------------|------------|
| 14731★ | Fawn              | 139.95 Ea. |
| 14732★ | Blue              | 139.95 Ea. |
| 14733★ | Turquoise         | 139.95 Ea. |
| 14734★ | Green             | 139.95 Ea. |
| 14735★ | Gold              | 139.95 Ea. |
| 14736★ | White             | 139.95 Ea. |
| 14737★ | Black             | 139.95 Ea. |
| 14770★ | Saddle            | 139.95 Ea. |
| 14781★ | Red               | 139.95 Ea. |

★ = special order non-stocking item, please allow 4-6 weeks for delivery.

① = add \$8.95 handling per item

Interiors CANNOT be returned!

# Interior

## 1963 HEADLINERS-CONTINUED

Headliners come pre-sewn ready to install with material included to re-cover the sunvisors. Correct Vinyl or Cloth is used.

| 63 IMPALA 4-DR WAGON |                   |            |
|----------------------|-------------------|------------|
| Part #               | Color Combination | Price      |
| 14752★               | Fawn              | 189.95 Ea. |
| 14753★               | Blue              | 189.95 Ea. |
| 14754★               | Turquoise         | 189.95 Ea. |
| 14755★               | Green             | 189.95 Ea. |
| 14756★               | White             | 189.95 Ea. |
| 14757★               | Saddle            | 189.95 Ea. |
| 14758★               | Black             | 189.95 Ea. |
| 14775★               | Red               | 189.95 Ea. |

| 63 IMPALA 4-DR HARDTOP |                   |            |
|------------------------|-------------------|------------|
| Part #                 | Color Combination | Price      |
| 14765★                 | Fawn              | 169.95 Ea. |
| 14766★                 | Blue              | 169.95 Ea. |
| 14767★                 | Turquoise         | 169.95 Ea. |
| 14768★                 | Green             | 169.95 Ea. |
| 14769★                 | White             | 169.95 Ea. |
| 14771★                 | Saddle            | 169.95 Ea. |
| 14772★                 | Black             | 169.95 Ea. |

| 63 BEL-AIR WAGON |                   |            |
|------------------|-------------------|------------|
| Part #           | Color Combination | Price      |
| 15378★           | Fawn              | 189.95 Ea. |
| 15379★           | Green             | 189.95 Ea. |
| 15380★           | Light Blue        | 189.95 Ea. |
| 15381★           | White             | 189.95 Ea. |
| 15382★           | Turquoise         | 189.95 Ea. |

## 1964 HEADLINERS

Headliners come pre-sewn ready to install with material included to re-cover the sunvisors. Correct Vinyl or Cloth is used.

| 64 BEL-AIR WAGON |                   |            |
|------------------|-------------------|------------|
| Part #           | Color Combination | Price      |
| 15378★           | Fawn              | 189.95 Ea. |
| 15379★           | Green             | 189.95 Ea. |
| 15380★           | Light Blue        | 189.95 Ea. |
| 15381★           | White             | 189.95 Ea. |
| 15382★           | Turquoise         | 189.95 Ea. |

| 64 IMPALA 4-DR SEDAN |                   |            |
|----------------------|-------------------|------------|
| Part #               | Color Combination | Price      |
| 14745★               | Oyster            | 169.95 Ea. |
| 14746★               | Blue              | 169.95 Ea. |
| 14747★               | Turquoise         | 169.95 Ea. |
| 14748★               | Green             | 169.95 Ea. |
| 14750★               | White             | 169.95 Ea. |
| 14773★               | Saddle            | 169.95 Ea. |
| 14751★               | Black             | 169.95 Ea. |

| 64 IMPALA & SS 2-DR HARDTOP |                   |            |
|-----------------------------|-------------------|------------|
| Part #                      | Color Combination | Price      |
| 14731★                      | Oyster            | 169.95 Ea. |
| 14732★                      | Blue              | 169.95 Ea. |
| 14733★                      | Turquoise         | 169.95 Ea. |
| 14736★                      | White             | 169.95 Ea. |
| 14770★                      | Saddle            | 169.95 Ea. |
| 14737★                      | Black             | 169.95 Ea. |
| 14781★                      | Red               | 169.95 Ea. |
| 14782★                      | Silver            | 169.95 Ea. |

| 64 BEL-AIR/BISCAYNE SEDAN |                   |            |
|---------------------------|-------------------|------------|
| Part #                    | Color Combination | Price      |
| 14783★                    | Fawn              | 169.95 Ea. |
| 14784★                    | Blue              | 169.95 Ea. |
| 14785★                    | Turquoise         | 169.95 Ea. |
| 14786★                    | Green             | 169.95 Ea. |
| 14787★                    | White             | 169.95 Ea. |

| 64 IMPALA 4-DR HARDTOP |                   |            |
|------------------------|-------------------|------------|
| Part #                 | Color Combination | Price      |
| 14765★                 | Oyster            | 169.95 Ea. |
| 14766★                 | Blue              | 169.95 Ea. |
| 14767★                 | Turquoise         | 169.95 Ea. |
| 14768★                 | Green             | 169.95 Ea. |
| 14769★                 | White             | 169.95 Ea. |
| 14771★                 | Saddle            | 169.95 Ea. |
| 14772★                 | Black             | 169.95 Ea. |

| 64 IMPALA 4-DR WAGON |                   |            |
|----------------------|-------------------|------------|
| Part #               | Color Combination | Price      |
| 14752★               | Oyster            | 189.95 Ea. |
| 14753★               | Blue              | 189.95 Ea. |
| 14754★               | Turquoise         | 189.95 Ea. |
| 14755★               | Green             | 189.95 Ea. |
| 14757★               | White             | 189.95 Ea. |
| 14758★               | Saddle            | 189.95 Ea. |
| 14759★               | Black             | 189.95 Ea. |
| 15383★               | Red               | 189.95 Ea. |

## 1965 HEADLINERS

Headliners come pre-sewn ready to install with material included to re-cover the sunvisors. Correct Vinyl or Cloth is used.

| 65 IMPALA 2-DR HARDTOP |                   |            |
|------------------------|-------------------|------------|
| Part #                 | Color Combination | Price      |
| 14788★                 | Dark Red          | 139.95 Ea. |
| 14789★                 | Medium Blue       | 139.95 Ea. |
| 14791★                 | Black             | 139.95 Ea. |
| 14792★                 | Fawn              | 139.95 Ea. |
| 14793★                 | Turquoise         | 139.95 Ea. |
| 14794★                 | White             | 139.95 Ea. |
| 14795★                 | Saddle            | 139.95 Ea. |
| 14796★                 | Green             | 139.95 Ea. |

| 65 IMPALA 4-DR HARDTOP |                   |            |
|------------------------|-------------------|------------|
| Part #                 | Color Combination | Price      |
| 14797★                 | Dark Red          | 169.95 Ea. |
| 14798★                 | Medium Blue       | 169.95 Ea. |
| 14799★                 | Black             | 169.95 Ea. |
| 14800★                 | Fawn              | 169.95 Ea. |
| 14801★                 | Turquoise         | 169.95 Ea. |
| 14802★                 | White             | 169.95 Ea. |
| 14803★                 | Saddle            | 169.95 Ea. |
| 14804★                 | Green             | 169.95 Ea. |

| 65 IMPALA SS 2-DR HARDTOP |                   |            |
|---------------------------|-------------------|------------|
| Part #                    | Color Combination | Price      |
| 14788★                    | Dark Red          | 139.95 Ea. |
| 14789★                    | Medium Blue       | 139.95 Ea. |
| 14790★                    | Slate             | 139.95 Ea. |
| 14791★                    | Black             | 139.95 Ea. |
| 14792★                    | Fawn              | 139.95 Ea. |

★ = special order non-stocking item, please allow 4-6 weeks for delivery.

Interiors CANNOT be returned!

# Interior

## 1965 HEADLINERS-CONTINUED

Headliners come presewn ready to install with material included to re-cover the sunvisors. Correct Vinyl or Cloth is used.

### 65 IMPALA 4-DR SEDAN

| Part # | Color Combination | Price      |
|--------|-------------------|------------|
| 14805★ | Dark Red          | 169.95 Ea. |
| 14806★ | Medium Blue       | 169.95 Ea. |
| 14807★ | Black             | 169.95 Ea. |
| 14808★ | Fawn              | 169.95 Ea. |
| 14809★ | Turquoise         | 169.95 Ea. |
| 14810★ | White             | 169.95 Ea. |
| 14811★ | Saddle            | 169.95 Ea. |
| 14812★ | Green             | 169.95 Ea. |

### 65 BISCAYNE 2-DR SEDAN

| Part # | Color Combination | Price      |
|--------|-------------------|------------|
| 14813★ | Fawn              | 169.95 Ea. |
| 14814★ | Blue              | 169.95 Ea. |
| 14815★ | Turquoise         | 169.95 Ea. |
| 14816★ | Green             | 169.95 Ea. |
| 14817★ | White             | 169.95 Ea. |

### 65 IMPALA WAGON

| Part # | Color Combination | Price      |
|--------|-------------------|------------|
| 15384★ | Fawn              | 199.95 Ea. |
| 15385★ | Turquoise         | 199.95 Ea. |
| 15386★ | White             | 199.95 Ea. |
| 15387★ | Light Blue        | 199.95 Ea. |
| 15388★ | Green             | 199.95 Ea. |
| 15389★ | Saddle            | 199.95 Ea. |

## 1966 HEADLINERS

Headliners come presewn ready to install with material included to re-cover the sunvisors. Correct Vinyl or Cloth is used.

### 66 IMPALA SS 2-DR HARDTOP

| Part # | Color Combination | Price      |
|--------|-------------------|------------|
| 14818★ | Black             | 139.95 Ea. |
| 14819★ | Red               | 139.95 Ea. |
| 14820★ | White             | 139.95 Ea. |
| 14821★ | Turquoise         | 139.95 Ea. |
| 14822★ | Medium Blue       | 139.95 Ea. |
| 14823★ | Bright Blue       | 139.95 Ea. |
| 14824★ | Fawn              | 139.95 Ea. |
| 14825★ | Green             | 139.95 Ea. |

### 66 IMPALA 2-DR HARDTOP

| Part # | Color Combination | Price      |
|--------|-------------------|------------|
| 14818★ | Black             | 139.95 Ea. |
| 14819★ | Red               | 139.95 Ea. |
| 14820★ | White             | 139.95 Ea. |
| 14821★ | Turquoise         | 139.95 Ea. |
| 14822★ | Medium Blue       | 139.95 Ea. |
| 14824★ | Fawn              | 139.95 Ea. |
| 14825★ | Green             | 139.95 Ea. |

### 66 IMPALA 4-DR HARDTOP

| Part # | Color Combination | Price      |
|--------|-------------------|------------|
| 14826★ | Black             | 169.95 Ea. |
| 14827★ | Red               | 169.95 Ea. |
| 14828★ | White             | 169.95 Ea. |
| 14829★ | Turquoise         | 169.95 Ea. |
| 14830★ | Medium Blue       | 169.95 Ea. |
| 14831★ | Fawn              | 169.95 Ea. |
| 14832★ | Green             | 169.95 Ea. |

### 66 IMPALA 4-DR SEDAN

| Part # | Color Combination | Price      |
|--------|-------------------|------------|
| 14833★ | Black             | 169.95 Ea. |
| 14834★ | Red               | 169.95 Ea. |
| 14835★ | White             | 169.95 Ea. |
| 14836★ | Turquoise         | 169.95 Ea. |
| 14837★ | Medium Blue       | 169.95 Ea. |
| 14838★ | Fawn              | 169.95 Ea. |
| 14839★ | Green             | 169.95 Ea. |

## 1966 HEADLINERS

Headliners come presewn ready to install with material included to re-cover the sunvisors. Correct Vinyl or Cloth is used.

### 67 IMPALA SS 2-DR HARDTOP

| Part # | Color Combination | Price      |
|--------|-------------------|------------|
| 14840★ | Bright Blue       | 139.95 Ea. |
| 14841★ | Gold              | 139.95 Ea. |
| 14842★ | Black             | 139.95 Ea. |
| 14845★ | Red               | 139.95 Ea. |

### 67 IMPALA 2-DR HARDTOP

| Part # | Color Combination | Price      |
|--------|-------------------|------------|
| 14840★ | Bright Blue       | 139.95 Ea. |
| 14841★ | Gold              | 139.95 Ea. |
| 14842★ | Black             | 139.95 Ea. |
| 14843★ | Light Blue        | 139.95 Ea. |
| 14844★ | Turquoise         | 139.95 Ea. |
| 14845★ | Red               | 139.95 Ea. |

★ = special order non-stocking item, please allow 4-6 weeks for delivery.

Interiors CANNOT be returned!

# Interior

## 1968 HEADLINERS

Headliners come pre-sewn ready to install with material included to re-cover the sunvisors. Correct Vinyl or Cloth is used.

| 68 IMPALA & SS 2-DR HARDTOP |                   |            |
|-----------------------------|-------------------|------------|
| Part #                      | Color Combination | Price      |
| 14846★                      | Black             | 139.95 Ea. |
| 14847★                      | Red               | 139.95 Ea. |
| 14848★                      | Blue              | 139.95 Ea. |
| 14849★                      | Ivy Gold          | 139.95 Ea. |

| 68 IMPALA CUSTOM HARDTOP |                   |            |
|--------------------------|-------------------|------------|
| Part #                   | Color Combination | Price      |
| 14850★                   | Blue              | 169.95 Ea. |
| 14851★                   | Ivy Gold          | 169.95 Ea. |
| 14852★                   | Black             | 169.95 Ea. |
| 14853★                   | Red               | 169.95 Ea. |
| 14854★                   | Turquoise         | 169.95 Ea. |

| 68 BISCAYNE 2-DR SEDAN |                   |            |
|------------------------|-------------------|------------|
| Part #                 | Color Combination | Price      |
| 14855★                 | Black             | 169.95 Ea. |
| 14856★                 | Blue              | 169.95 Ea. |
| 14857★                 | Ivy Gold          | 169.95 Ea. |

## 1969 HEADLINERS

Headliners come pre-sewn ready to install with material included to re-cover the sunvisors. Correct Vinyl or Cloth is used.

| 69 IMPALA SS 2-DR HARDTOP |                   |            |
|---------------------------|-------------------|------------|
| Part #                    | Color Combination | Price      |
| 14858★                    | Black             | 139.95 Ea. |
| 14859★                    | Red               | 139.95 Ea. |
| 14860★                    | Parchment         | 139.95 Ea. |
| 14861★                    | Dark Blue         | 139.95 Ea. |
| 14862★                    | Ivy Green         | 139.95 Ea. |

| 69 IMPALA CUSTOM 2-DR HARDTOP |                   |            |
|-------------------------------|-------------------|------------|
| Part #                        | Color Combination | Price      |
| 14863★                        | Black             | 169.95 Ea. |
| 14864★                        | Red               | 169.95 Ea. |
| 14865★                        | Parchment         | 169.95 Ea. |
| 14866★                        | Dark Blue         | 169.95 Ea. |
| 14867★                        | Ivy Green         | 169.95 Ea. |

## 1970 HEADLINERS

Headliners come pre-sewn ready to install with material included to re-cover the sunvisors. Correct Vinyl or Cloth is used.

| 70 IMPALA SS 2-DR HARDTOP |                   |            |
|---------------------------|-------------------|------------|
| Part #                    | Color Combination | Price      |
| 14868★                    | Black             | 139.95 Ea. |
| 14869★                    | Red               | 139.95 Ea. |
| 14870★                    | Medium Blue       | 139.95 Ea. |
| 14871★                    | Light Saddle      | 139.95 Ea. |
| 14872★                    | Dark Green        | 139.95 Ea. |
| 14873★                    | Sandalwood        | 139.95 Ea. |

| 70 IMPALA CUSTOM 2-DR HARDTOP |                   |            |
|-------------------------------|-------------------|------------|
| Part #                        | Color Combination | Price      |
| 14863★                        | Black             | 169.95 Ea. |
| 14874★                        | Red               | 169.95 Ea. |
| 14875★                        | Medium Blue       | 169.95 Ea. |
| 14876★                        | Light Saddle      | 169.95 Ea. |
| 14877★                        | Dark Green        | 169.95 Ea. |

### HEADLINER BOWS

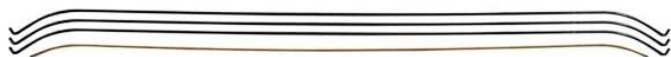

| Part # | Year  | Model        | Part           | Price     |
|--------|-------|--------------|----------------|-----------|
| 16022  | 61-62 | Bubble Top   | Headliner Bows | 59.95 Set |
| 16023  | 62    | 2-Dr Hardtop | Headliner Bows | 69.95 Set |
| 16024  | 63-64 | 2-Dr Hardtop | Headliner Bows | 69.95 Set |
| 16025  | 63-64 | 4-Dr Hardtop | Headliner Bows | 69.95 Set |
| 16026  | 65-66 | 2-Dr Hardtop | Headliner Bows | 65.95 Set |
| 16027  | 67-68 | 2-Dr Hardtop | Headliner Bows | 69.95 Set |

### SAIL PANELS



| Part # | Year  | Model           | Part        | Price      |
|--------|-------|-----------------|-------------|------------|
| 15576  | 58    | Impala Hardtop  | Sail Panels | 13.95 Pair |
| 15577  | 58    | Bel-Air Hardtop | Sail Panels | 15.95 Pair |
| 15579  | 62-64 | Impala Hardtop  | Sail Panels | 16.95 Pair |
| 15580  | 65-66 | Impala Hardtop  | Sail Panels | 18.95 Pair |
| 15581  | 67-68 | Impala Hardtop  | Sail Panels | 16.95 Pair |

★ = special order non-stocking item, please allow 4-6 weeks for delivery.

Interiors CANNOT be returned!

# Interior

## 1958 SUNVISORS

Presewn pairs on new boards with correct Vinyl or Cloth material, binding, rods and clips. Ready to install.

### 58 IMPALA CONVERTIBLE

| Part # | Color Combination | Price       |
|--------|-------------------|-------------|
| 14878★ | Dark Turquoise    | 135.95 Pair |
| 3502 ★ | Silver            | 135.95 Pair |
| 14880★ | Gold              | 135.95 Pair |
| 3473 ★ | Red               | 135.95 Pair |
| 14881★ | Coral             | 135.95 Pair |
| 3478 ★ | Black             | 135.95 Pair |
| 3491 ★ | Dark Green        | 135.95 Pair |
| 3492 ★ | Dark Blue         | 135.95 Pair |

### 58 IMPALA 2-DR HARDTOP

| Part # | Color Combination | Price       |
|--------|-------------------|-------------|
| 14882★ | Silver            | 135.95 Pair |
| 3495 ★ | Beige             | 135.95 Pair |
| 3498 ★ | Light Turquoise   | 135.95 Pair |
| 3499 ★ | Green             | 135.95 Pair |
| 14883★ | Blue              | 135.95 Pair |
| 3496 ★ | Coral             | 135.95 Pair |

### 58 BEL-AIR HARDTOP

| Part # | Color Combination | Price       |
|--------|-------------------|-------------|
| 14884★ | Coral             | 135.95 Pair |
| 3507 ★ | Silver            | 135.95 Pair |
| 3508 ★ | Turquoise         | 135.95 Pair |
| 3509 ★ | Blue              | 135.95 Pair |
| 3510 ★ | Beige             | 135.95 Pair |
| 3511 ★ | Green             | 135.95 Pair |

### 58 BEL-AIR SEDAN

| Part # | Color Combination | Price       |
|--------|-------------------|-------------|
| 14885★ | Gold              | 135.95 Pair |
| 3514 ★ | Beige             | 135.95 Pair |
| 3515 ★ | Gray              | 135.95 Pair |
| 3516 ★ | Blue              | 135.95 Pair |
| 3518 ★ | Turquoise         | 135.95 Pair |
| 3517 ★ | Green             | 135.95 Pair |
| 14879★ | Coral             | 135.95 Pair |

### 58 NOMAD WAGON

| Part # | Color Combination | Price       |
|--------|-------------------|-------------|
| 14886★ | Gold              | 135.95 Pair |
| 14887★ | Beige             | 135.95 Pair |
| 14888★ | Gray              | 135.95 Pair |
| 14889★ | Blue              | 135.95 Pair |
| 14890★ | Turquoise         | 135.95 Pair |
| 3507 ★ | Silver            | 135.95 Pair |
| 3511 ★ | Green             | 135.95 Pair |

## 1959 SUNVISORS

Presewn pairs on new boards with correct Vinyl or Cloth material, binding, rods and clips. Ready to install.

### 59 IMPALA CONVERTIBLE

| Part # | Color Combination | Price       |
|--------|-------------------|-------------|
| 14891★ | Red               | 135.95 Pair |
| 14892★ | Jewel Blue        | 135.95 Pair |
| 14893★ | Dark Turquoise    | 135.95 Pair |
| 14894★ | Dark Green        | 135.95 Pair |
| 14895★ | Copper            | 135.95 Pair |
| 14896★ | Gray              | 135.95 Pair |
| 14897★ | Black             | 135.95 Pair |

### 59 IMPALA HARDTOP

| Part # | Color Combination | Price       |
|--------|-------------------|-------------|
| 14898★ | Silver            | 135.95 Pair |
| 14899★ | Copper            | 135.95 Pair |
| 14900★ | Turquoise         | 135.95 Pair |
| 14901★ | Blue              | 135.95 Pair |
| 14902★ | Green             | 135.95 Pair |

### 59 IMPALA SEDAN

| Part # | Color Combination | Price       |
|--------|-------------------|-------------|
| 15401★ | Gray              | 135.95 Pair |
| 15402★ | Light Blue        | 135.95 Pair |
| 15403★ | Turquoise         | 135.95 Pair |
| 15404★ | Light Green       | 135.95 Pair |
| 15405★ | Copper            | 135.95 Pair |

### 59 EL CAMINO

| Part # | Color Combination | Price       |
|--------|-------------------|-------------|
| 14903★ | Copper            | 135.95 Pair |
| 14904★ | Silver            | 135.95 Pair |
| 14905★ | Turquoise         | 135.95 Pair |
| 14906★ | Blue              | 135.95 Pair |
| 14907★ | Green             | 135.95 Pair |

## 1960 SUNVISORS

Presewn pairs on new boards with correct Vinyl or Cloth material, binding, rods and clips. Ready to install.

### 60 IMPALA SEDAN

| Part # | Color Combination | Price       |
|--------|-------------------|-------------|
| 15401★ | Gray              | 135.95 Pair |
| 15402★ | Light Blue        | 135.95 Pair |
| 15403★ | Turquoise         | 135.95 Pair |
| 15404★ | Light Green       | 135.95 Pair |
| 15405★ | Copper            | 135.95 Pair |

### 60 IMPALA CONVERTIBLE

| Part # | Color Combination | Price       |
|--------|-------------------|-------------|
| 14891★ | Red               | 135.95 Pair |
| 14892★ | Jewel Blue        | 135.95 Pair |
| 14893★ | Dark Turquoise    | 135.95 Pair |
| 14894★ | Dark Green        | 135.95 Pair |
| 14895★ | Copper            | 135.95 Pair |

★ = special order non-stocking item, please allow 4-6 weeks for delivery.

Interiors CANNOT be returned!

# Interior

## 1960 SUNVISORS-CONTINUED

Presewn pairs on new boards with correct Vinyl or Cloth material, binding, rods and clips. Ready to install.

| 60 IMPALA HARDTOP |                   |             |
|-------------------|-------------------|-------------|
| Part #            | Color Combination | Price       |
| 14899★            | Copper            | 135.95 Pair |
| 14900★            | Turquoise         | 135.95 Pair |
| 14901★            | Blue              | 135.95 Pair |
| 14902★            | Green             | 135.95 Pair |
| 14908★            | White             | 135.95 Pair |

| 60 BEL-AIR 2-DR SEDAN |                   |             |
|-----------------------|-------------------|-------------|
| Part #                | Color Combination | Price       |
| 15401★                | Gray              | 135.95 Pair |
| 15402★                | Light Blue        | 135.95 Pair |
| 15403★                | Turquoise         | 135.95 Pair |
| 15404★                | Light Green       | 135.95 Pair |
| 15405★                | Copper            | 135.95 Pair |

| 60 EL CAMINO |                   |             |
|--------------|-------------------|-------------|
| Part #       | Color Combination | Price       |
| 14903★       | Copper            | 135.95 Pair |
| 14904★       | Silver            | 135.95 Pair |
| 14905★       | Turquoise         | 135.95 Pair |
| 14906★       | Blue              | 135.95 Pair |
| 14907★       | Green             | 135.95 Pair |

## 1961 SUNVISORS

Presewn pairs on new boards with correct Vinyl or Cloth material, binding, rods and clips. Ready to install.

| 61 IMPALA CONVERTIBLE |                   |            |
|-----------------------|-------------------|------------|
| Part #                | Color Combination | Price      |
| 14909★                | Red               | 99.95 Pair |
| 14910★                | Fawn              | 99.95 Pair |
| 14911★                | Jewel Blue        | 99.95 Pair |
| 14912★                | Dark Green        | 99.95 Pair |
| 14913★                | Dark Turquoise    | 99.95 Pair |
| 14914★                | Gold              | 99.95 Pair |
| 14918★                | Gray              | 99.95 Pair |

| 61 IMPALA HARDTOP |                   |            |
|-------------------|-------------------|------------|
| Part #            | Color Combination | Price      |
| 14919★            | White             | 99.95 Pair |
| 14920★            | Turquoise         | 99.95 Pair |
| 14921★            | Blue              | 99.95 Pair |
| 14922★            | Beige             | 99.95 Pair |
| 14923★            | Green             | 99.95 Pair |

| 61 IMPALA/BEL-AIR SEDAN |                   |             |
|-------------------------|-------------------|-------------|
| Part #                  | Color Combination | Price       |
| 15411★                  | Gray              | 135.95 Pair |
| 15412★                  | Light Blue        | 135.95 Pair |
| 15413★                  | Turquoise         | 135.95 Pair |
| 15414★                  | Fawn              | 135.95 Pair |
| 15415★                  | Light Green       | 135.95 Pair |

| 61 BEL-AIR HARDTOP/WAGON |                   |             |
|--------------------------|-------------------|-------------|
| Part #                   | Color Combination | Price       |
| 15406★                   | White             | 135.95 Pair |
| 15407★                   | Blue              | 135.95 Pair |
| 15408★                   | Turquoise         | 135.95 Pair |
| 15409★                   | Fawn              | 135.95 Pair |
| 15410★                   | Green             | 135.95 Pair |

## 1962 SUNVISORS

Presewn pairs on new boards with correct Vinyl or Cloth material, binding, rods and clips. Ready to install.

| 62 IMPALA & SS CONVERTIBLE |                   |            |
|----------------------------|-------------------|------------|
| Part #                     | Color Combination | Price      |
| 14909★                     | Red               | 99.95 Pair |
| 14910★                     | Fawn              | 99.95 Pair |
| 14914★                     | Blue              | 99.95 Pair |
| 14915★                     | Turquoise         | 99.95 Pair |
| 14916★                     | Green             | 99.95 Pair |
| 14917★                     | Gold              | 99.95 Pair |
| 14924★                     | Black             | 99.95 Pair |

| 62 IMPALA HARDTOP/SEDAN/WAGON |                   |            |
|-------------------------------|-------------------|------------|
| Part #                        | Color Combination | Price      |
| 14925★                        | White             | 99.95 Pair |
| 14926★                        | Black             | 99.95 Pair |
| 14927★                        | Blue              | 99.95 Pair |
| 14928★                        | Fawn              | 99.95 Pair |
| 14929★                        | Turquoise         | 99.95 Pair |
| 14931★                        | Green             | 99.95 Pair |
| 14932★                        | Gold              | 99.95 Pair |

| 62 BEL-AIR SEDAN |                   |             |
|------------------|-------------------|-------------|
| Part #           | Color Combination | Price       |
| 15411★           | Gray              | 135.95 Pair |
| 15412★           | Light Blue        | 135.95 Pair |
| 15413★           | Turquoise         | 135.95 Pair |
| 15414★           | Fawn              | 135.95 Pair |
| 15415★           | Light Green       | 135.95 Pair |

| 62 BEL-AIR 2-DR HARDTOP |                   |             |
|-------------------------|-------------------|-------------|
| Part #                  | Color Combination | Price       |
| 15406★                  | White             | 135.95 Pair |
| 15407★                  | Blue              | 135.95 Pair |
| 15408★                  | Turquoise         | 135.95 Pair |
| 15409★                  | Fawn              | 135.95 Pair |
| 15410★                  | Green             | 135.95 Pair |

| 62 BEL-AIR WAGON |                   |             |
|------------------|-------------------|-------------|
| Part #           | Color Combination | Price       |
| 15416★           | White             | 135.95 Pair |
| 15417★           | Light Blue        | 135.95 Pair |
| 15418★           | Turquoise         | 135.95 Pair |
| 15419★           | Fawn              | 135.95 Pair |
| 15420★           | Green             | 135.95 Pair |

★ = special order non-stocking item, please allow 4-6 weeks for delivery.

Interiors CANNOT be returned!

# Interior

## 1963 SUNVISORS

Presewn pairs on new boards with correct Vinyl or Cloth material, binding, rods and clips. Ready to install.

### 63 BEL-AIR WAGON

| Part # | Color Combination | Price       |
|--------|-------------------|-------------|
| 15416★ | White             | 135.95 Pair |
| 15417★ | Light Blue        | 135.95 Pair |
| 15418★ | Turquoise         | 135.95 Pair |
| 15419★ | Fawn              | 135.95 Pair |
| 15420★ | Green             | 135.95 Pair |

### 63 IMPALA SEDAN

| Part # | Color Combination | Price      |
|--------|-------------------|------------|
| 14925★ | White             | 99.95 Pair |
| 14926★ | Black             | 99.95 Pair |
| 14927★ | Blue              | 99.95 Pair |
| 14928★ | Fawn              | 99.95 Pair |
| 14929★ | Turquoise         | 99.95 Pair |
| 14930★ | Saddle            | 99.95 Pair |
| 14931★ | Green             | 99.95 Pair |
| 15426★ | Dark Red          | 99.95 Pair |

### 63 BEL-AIR/BISCAYNE SEDAN

| Part # | Color Combination | Price       |
|--------|-------------------|-------------|
| 15421★ | Blue              | 135.95 Pair |
| 15422★ | Turquoise         | 135.95 Pair |
| 15423★ | Fawn              | 135.95 Pair |
| 15424★ | Green             | 135.95 Pair |
| 15425★ | White             | 135.95 Pair |

### 63 IMPALA WAGON

| Part # | Color Combination | Price      |
|--------|-------------------|------------|
| 14925★ | White             | 99.95 Pair |
| 14926★ | Black             | 99.95 Pair |
| 14927★ | Blue              | 99.95 Pair |
| 14928★ | Fawn              | 99.95 Pair |
| 14929★ | Turquoise         | 99.95 Pair |
| 14930★ | Saddle            | 99.95 Pair |
| 14931★ | Green             | 99.95 Pair |
| 15426★ | Dark Red          | 99.95 Pair |

### 63 IMPALA HARDTOP

| Part # | Color Combination | Price      |
|--------|-------------------|------------|
| 14925★ | White             | 99.95 Pair |
| 14926★ | Black             | 99.95 Pair |
| 14927★ | Blue              | 99.95 Pair |
| 14928★ | Fawn              | 99.95 Pair |
| 14929★ | Turquoise         | 99.95 Pair |
| 14930★ | Saddle            | 99.95 Pair |
| 14931★ | Green             | 99.95 Pair |
| 15426★ | Dark Red          | 99.95 Pair |

### 63 IMPALA & SS CONVERTIBLE

| Part # | Color Combination | Price      |
|--------|-------------------|------------|
| 14933★ | Fawn              | 99.95 Pair |
| 14934★ | Blue              | 99.95 Pair |
| 14935★ | Turquoise         | 99.95 Pair |
| 14936★ | Green             | 99.95 Pair |
| 14937★ | Saddle            | 99.95 Pair |
| 14938★ | Dark Red          | 99.95 Pair |
| 14939★ | Black             | 99.95 Pair |
| 14940★ | White             | 99.95 Pair |

## 1964 SUNVISORS

Presewn pairs on new boards with correct Vinyl or Cloth material, binding, rods and clips. Ready to install.

### 64 IMPALA & SS CONVERTIBLE

| Part # | Color Combination | Price      |
|--------|-------------------|------------|
| 14941★ | Oyster            | 99.95 Pair |
| 14942★ | White             | 99.95 Pair |
| 14943★ | Black             | 99.95 Pair |
| 14944★ | Turquoise         | 99.95 Pair |
| 14945★ | Dark Red          | 99.95 Pair |
| 14946★ | Green             | 99.95 Pair |
| 14947★ | Saddle            | 99.95 Pair |
| 14948★ | Blue              | 99.95 Pair |
| 15432★ | Silver            | 99.95 Pair |

### 64 IMPALA HARDTOP/SEDAN

| Part # | Color Combination | Price      |
|--------|-------------------|------------|
| 14949★ | White             | 99.95 Pair |
| 14950★ | Black             | 99.95 Pair |
| 14951★ | Blue              | 99.95 Pair |
| 14952★ | Oyster            | 99.95 Pair |
| 14953★ | Red               | 99.95 Pair |
| 14954★ | Saddle            | 99.95 Pair |
| 14955★ | Turquoise         | 99.95 Pair |
| 14956★ | Green             | 99.95 Pair |

### 64 IMPALA WAGON

| Part # | Color Combination | Price      |
|--------|-------------------|------------|
| 14949★ | White             | 99.95 Pair |
| 14950★ | Black             | 99.95 Pair |
| 14951★ | Blue              | 99.95 Pair |
| 14952★ | Oyster            | 99.95 Pair |
| 14953★ | Red               | 99.95 Pair |
| 14954★ | Saddle            | 99.95 Pair |
| 14955★ | Turquoise         | 99.95 Pair |
| 14956★ | Green             | 99.95 Pair |

### 64 BEL-AIR SEDAN/WAGON

| Part # | Color Combination | Price      |
|--------|-------------------|------------|
| 14949★ | White             | 99.95 Pair |
| 14951★ | Light Blue        | 99.95 Pair |
| 14952★ | Oyster            | 99.95 Pair |
| 14953★ | Dark Red          | 99.95 Pair |
| 14955★ | Turquoise         | 99.95 Pair |
| 14956★ | Green             | 99.95 Pair |

### 64 BEL-AIR HARDTOP

| Part # | Color Combination | Price      |
|--------|-------------------|------------|
| 14949★ | White             | 99.95 Pair |
| 14951★ | Light Blue        | 99.95 Pair |
| 14952★ | Oyster            | 99.95 Pair |
| 14953★ | Dark Red          | 99.95 Pair |
| 14955★ | Turquoise         | 99.95 Pair |
| 14956★ | Green             | 99.95 Pair |

### 64 BEL-AIR/BISCAYNE SEDAN

| Part # | Color Combination | Price       |
|--------|-------------------|-------------|
| 15427★ | Blue              | 135.95 Pair |
| 15428★ | Light Turquoise   | 135.95 Pair |
| 15429★ | Oyster            | 135.95 Pair |
| 15430★ | Light Green       | 135.95 Pair |
| 15431★ | Ivory             | 135.95 Pair |

★ = special order non-stocking item, please allow 4-6 weeks for delivery.

Interiors CANNOT be returned!

# Interior

## 1965 SUNVISORS

Presewn pairs on new boards with correct Vinyl or Cloth material, binding, rods and clips. Ready to install.

### 65 IMPALA & SS CONVERTIBLE

| Part # | Color Combination | Price      |
|--------|-------------------|------------|
| 14957★ | Red               | 99.95 Pair |
| 14958★ | Blue              | 99.95 Pair |
| 14959★ | Black             | 99.95 Pair |
| 14960★ | Fawn              | 99.95 Pair |
| 14961★ | Turquoise         | 99.95 Pair |
| 14962★ | White             | 99.95 Pair |
| 14963★ | Saddle            | 99.95 Pair |
| 14964★ | Green             | 99.95 Pair |
| 15433★ | White (SS Only)   | 99.95 Pair |

### 65 IMPALA HARDTOP/SS HARDTOP/SEDAN

| Part # | Color Combination | Price      |
|--------|-------------------|------------|
| 14965★ | Dark Red          | 99.95 Pair |
| 14966★ | Light Blue        | 99.95 Pair |
| 14967★ | Slate             | 99.95 Pair |
| 14968★ | Black             | 99.95 Pair |
| 14969★ | Fawn              | 99.95 Pair |
| 14970★ | Turquoise         | 99.95 Pair |
| 14971★ | White             | 99.95 Pair |
| 14972★ | Saddle            | 99.95 Pair |
| 14973★ | Green (Not SS)    | 99.95 Pair |

### 65 BISCAYNE 2-DR SEDAN

| Part # | Color Combination | Price       |
|--------|-------------------|-------------|
| 15434★ | Blue              | 135.95 Pair |
| 15435★ | Light Turquoise   | 135.95 Pair |
| 15436★ | Fawn              | 135.95 Pair |
| 15437★ | Green             | 135.95 Pair |
| 15438★ | White             | 135.95 Pair |

## 1966 SUNVISORS

Presewn pairs on new boards with correct Vinyl or Cloth material, binding, rods and clips. Ready to install.

### 66 BISCAYNE 2-DR SEDAN

| Part # | Color Combination | Price       |
|--------|-------------------|-------------|
| 15434★ | Blue              | 135.95 Pair |
| 15435★ | Light Turquoise   | 135.95 Pair |
| 15436★ | Fawn              | 135.95 Pair |
| 15437★ | Green             | 135.95 Pair |
| 15438★ | White             | 135.95 Pair |

### 66 IMPALA HARDTOP/SEDAN/WAGON

| Part # | Color Combination | Price      |
|--------|-------------------|------------|
| 14983★ | Black             | 99.95 Pair |
| 14984★ | Red               | 99.95 Pair |
| 14985★ | White             | 99.95 Pair |
| 14986★ | Turquoise         | 99.95 Pair |
| 14987★ | Medium Blue       | 99.95 Pair |
| 14988★ | Bright Blue       | 99.95 Pair |
| 14989★ | Fawn              | 99.95 Pair |
| 14990★ | Green             | 99.95 Pair |

### 66 IMPALA & SS CONVERTIBLE

| Part # | Color Combination | Price      |
|--------|-------------------|------------|
| 14974★ | Dark Red          | 99.95 Pair |
| 14975★ | Light Blue        | 99.95 Pair |
| 14976★ | Black             | 99.95 Pair |
| 14977★ | Fawn              | 99.95 Pair |
| 14978★ | Turquoise         | 99.95 Pair |
| 14979★ | White             | 99.95 Pair |
| 14980★ | Bright Blue       | 99.95 Pair |
| 14981★ | Green             | 99.95 Pair |

## 1967 SUNVISORS

Presewn pairs on new boards with correct Vinyl or Cloth material, binding, rods and clips. Ready to install.

### 67 IMPALA & SS CONVERTIBLE

| Part # | Color Combination | Price      |
|--------|-------------------|------------|
| 14974★ | Red               | 99.95 Pair |
| 14975★ | Light Blue        | 99.95 Pair |
| 14976★ | Black             | 99.95 Pair |
| 14978★ | Turquoise         | 99.95 Pair |
| 14980★ | Bright Blue       | 99.95 Pair |
| 14991★ | Off White         | 99.95 Pair |
| 14992★ | Gold              | 99.95 Pair |

### 67 IMPALA & SS 2-DR HARDTOP

| Part # | Color Combination | Price      |
|--------|-------------------|------------|
| 14993★ | Bright Blue       | 99.95 Pair |
| 14994★ | Gold              | 99.95 Pair |
| 14995★ | Black             | 99.95 Pair |
| 14996★ | Light Blue        | 99.95 Pair |
| 14997★ | Turquoise         | 99.95 Pair |
| 14998★ | Red               | 99.95 Pair |

★ = special order non-stocking item, please allow 4-6 weeks for delivery.

Interiors CANNOT be returned!

# Interior

## 1968 SUNVISORS

Presewn pairs on new boards with correct Vinyl or Cloth material, binding, rods and clips. Ready to install.

### 68 IMPALA & SS CONVERTIBLE

| Part # | Color Combination | Price      |
|--------|-------------------|------------|
| 14974★ | Red               | 99.95 Pair |
| 14975★ | Light Blue        | 99.95 Pair |
| 14976★ | Black             | 99.95 Pair |
| 14999★ | Parchment         | 99.95 Pair |
| 15000★ | Ivy Gold          | 99.95 Pair |

### 68 IMPALA & SS 2-DR HARDTOP

| Part # | Color Combination | Price      |
|--------|-------------------|------------|
| 15001★ | Blue              | 99.95 Pair |
| 15002★ | Ivy Gold          | 99.95 Pair |
| 15003★ | Black             | 99.95 Pair |
| 15004★ | Red               | 99.95 Pair |

## 1969 SUNVISORS

Presewn pairs on new boards with correct Vinyl or Cloth material, binding, rods and clips. Ready to install.

### 69 IMPALA CONVERTIBLE

| Part # | Color Combination | Price      |
|--------|-------------------|------------|
| 14974★ | Red               | 99.95 Pair |
| 14976★ | Black             | 99.95 Pair |
| 15005★ | Ivy Green         | 99.95 Pair |
| 15006★ | Dark Blue         | 99.95 Pair |
| 15007★ | Parchment         | 99.95 Pair |

### 69 IMPALA CUSTOM 2-DR HARDTOP

| Part # | Color Combination | Price       |
|--------|-------------------|-------------|
| 15012★ | Black             | 135.95 Pair |
| 15013★ | Red               | 135.95 Pair |
| 15014★ | Parchment         | 135.95 Pair |
| 15015★ | Dark Blue         | 135.95 Pair |
| 15440★ | Dark Green        | 135.95 Pair |

### 69 IMPALA SS 2-DR HARDTOP

| Part # | Color Combination | Price      |
|--------|-------------------|------------|
| 15008★ | Black             | 99.95 Pair |
| 15009★ | Red               | 99.95 Pair |
| 15010★ | Parchment         | 99.95 Pair |
| 15011★ | Dark Blue         | 99.95 Pair |
| 15439★ | Ivy Green         | 99.95 Pair |

## 1970 SUNVISORS

Presewn pairs on new boards with correct Vinyl or Cloth material, binding, rods and clips. Ready to install.

### 70 IMPALA CUSTOM HARDTOP

| Part # | Color Combination | Price       |
|--------|-------------------|-------------|
| 15012★ | Black             | 135.95 Pair |
| 15013★ | Red               | 135.95 Pair |
| 15014★ | Sandalwood        | 135.95 Pair |
| 15018★ | Light Saddle      | 135.95 Pair |
| 15440★ | Dark Green        | 135.95 Pair |
| 15441★ | Medium Blue       | 135.95 Pair |
| 15442★ | Turquoise         | 135.95 Pair |

### 70 IMPALA CONVERTIBLE

| Part # | Color Combination | Price      |
|--------|-------------------|------------|
| 14976★ | Black             | 99.95 Pair |
| 15016★ | Dark Green        | 99.95 Pair |
| 15017★ | Bright Red        | 99.95 Pair |

## CLOTH WINDLACE/SEDAN

Woven cloth windlace yardage on 1/2" foam core with kraft paper edging for all sedan models and wagons with the exception of Nomad.

| Part # | Color Combination | Price     |
|--------|-------------------|-----------|
| 2967 ★ | Black             | 8.50 Yard |
| 2968 ★ | Dark Blue         | 8.50 Yard |
| 2972 ★ | Light Blue        | 8.50 Yard |
| 2977 ★ | Red               | 8.50 Yard |
| 2970 ★ | Turquoise         | 8.50 Yard |
| 2973 ★ | Gray              | 8.50 Yard |
| 15094★ | Ivory             | 8.50 Yard |
| 2975 ★ | Beige             | 8.50 Yard |
| 2976 ★ | Brown             | 8.50 Yard |
| 2969 ★ | Dark Green        | 8.50 Yard |

| Part # | Color Combination | Price     |
|--------|-------------------|-----------|
| 15093★ | Light Green       | 8.50 Yard |
| 15095★ | Fawn              | 8.50 Yard |
| 15096★ | Coral             | 8.50 Yard |
| 2974 ★ | Copper            | 8.50 Yard |

★ = special order non-stocking item, please allow 4-6 weeks for delivery.

Interiors CANNOT be returned!

# Interior

## KICK PANELS



| Part # | Year  | Model         | Part  | Price      |
|--------|-------|---------------|-------|------------|
| 11480  | 58    | Hardtop/Sedan | Black | 15.95 Pair |
| 11481  | 58    | Hardtop/Sedan | Red   | 15.95 Pair |
| 11482  | 58    | Convertible   | Black | 15.95 Pair |
| 11483  | 58    | Convertible   | Red   | 15.95 Pair |
| 11484  | 59-60 | All           | Black | 15.95 Pair |
| 11485  | 59-60 | All           | Red   | 15.95 Pair |
| 11486  | 61-62 | w/AC          | Black | 15.95 Pair |
| 11487  | 61-62 | w/AC          | Red   | 15.95 Pair |
| 11488  | 61-62 | w/o AC        | Black | 15.95 Pair |
| 11489  | 61-62 | w/o AC        | Red   | 15.95 Pair |
| 11490  | 63-64 | w/AC          | Black | 15.95 Pair |
| 11491  | 63-64 | w/AC          | Red   | 15.95 Pair |
| 11492  | 63-64 | w/o AC        | Black | 15.95 Pair |
| 11493  | 63-64 | w/o AC        | Red   | 15.95 Pair |

## PACKAGE TRAYS



| Part # | Year  | Model                 | Part  | Price     |
|--------|-------|-----------------------|-------|-----------|
| 11501  | 58    | Bel-Air Hardtop/Sedan | Black | 22.95 Ea. |
| 11502  | 58    | Bel-Air Hardtop/Sedan | Red   | 22.95 Ea. |
| 11503  | 59-60 | Impala 2-Dr Hardtop   | Black | 22.95 Ea. |
| 11504  | 59-60 | Impala 2-Dr Hardtop   | Red   | 25.95 Ea. |
| 11505  | 59-60 | Impala 4-Dr Hardtop   | Black | 29.95 Ea. |
| 11506  | 59-60 | Impala 4-Dr Hardtop   | Red   | 25.95 Ea. |
| 11507  | 61    | Impala 2-Dr Hardtop   | Black | 28.95 Ea. |
| 11508  | 61    | Impala 2-Dr Hardtop   | Red   | 28.95 Ea. |
| 11509  | 61    | 2/4-Dr Sedan          | Black | 25.95 Ea. |
| 11510  | 61    | 2/4-Dr Sedan          | Red   | 25.95 Ea. |
| 11511  | 62-64 | Impala 2-Dr Hardtop   | Black | 28.95 Ea. |
| 11512  | 62-64 | Impala 2-Dr Hardtop   | Red   | 28.95 Ea. |
| 11513  | 63    | Impala 4-Dr Hardtop   | Black | 22.95 Ea. |
| 11514  | 64    | Impala 4-Dr Hardtop   | Black | 22.95 Ea. |
| 11515  | 62-64 | Impala 2/4-Dr Sedan   | Black | 22.95 Ea. |
| 11516  | 62-64 | Impala 2/4-Dr Sedan   | Red   | 22.95 Ea. |
| 11517  | 65-66 | Impala 2-Dr Hardtop   | Black | 29.95 Ea. |
| 11518  | 65-66 | Impala 2-Dr Hardtop   | Red   | 29.95 Ea. |
| 11519  | 65-66 | 2/4-Dr Sedan          | Black | 22.95 Ea. |
| 11520  | 65-66 | 2/4-Dr Sedan          | Red   | 22.95 Ea. |
| 11521  | 65-66 | Caprice 4-Dr Hardtop  | Black | 22.95 Ea. |
| 11522  | 66-67 | Caprice Coupe         | Black | 22.95 Ea. |
| 11523  | 67-68 | Impala Fastback       | Black | 23.95 Ea. |
| 11524  | 67-68 | Impala Fastback       | Red   | 23.95 Ea. |
| 11525  | 67-68 | Impala Coupe          | Black | 22.95 Ea. |
| 11526  | 67-68 | Impala Coupe          | Red   | 22.95 Ea. |
| 11527  | 67    | 4-Door Hardtop        | Black | 29.95 Ea. |
| 11528  | 68    | Caprice Coupe         | Black | 19.95 Ea. |
| 11529  | 68    | Caprice Coupe         | Red   | 19.95 Ea. |
| 11530  | 68    | Bel-Air               | Black | 22.95 Ea. |
| 11531  | 68    | Bel-Air               | Red   | 22.95 Ea. |

# Table of Contents

## A

|  |         |
|--|---------|
| A-Arm Bumpers _____                        | 100     |
| A-Arm Bushings _____                       | 100     |
| A-Arm Shafts _____                         | 100     |
| A-Arms _____                               | 100-101 |
| AC Bulk Heads _____                        | 4       |
| AC Compressor Brackets (Factory) _____     | 10      |
| AC Compressor Brackets (Aftermarket) _____ | 6-9     |
| AC Compressor Decals _____                 | 35      |
| AC Compressor Switches _____               | 10      |
| AC Compressors _____                       | 3       |
| AC Condensers _____                        | 4       |
| AC Driers _____                            | 4       |
| AC Duct Hose _____                         | 5       |
| AC Evaporator Box Decals _____             | 36      |
| AC Hose Grommets _____                     | 10      |
| AC Hose Kits _____                         | 5       |
| AC Systems _____                           | 1-3     |
| AC Vent Balls _____                        | 10      |
| AC Vent Louvers _____                      | 4       |
| AC Vents (Factory) _____                   | 10      |
| Accelerator Pedal Mounting Hardware _____  | 10      |
| Accelerator Pedal Parts _____              | 10      |
| Accelerator Pedals _____                   | 10      |
| A-Frame Dust Shields _____                 | 10      |
| Air Cleaner Assemblies _____               | 11      |
| Air Cleaner Decals _____                   | 35      |
| Air Cleaner Parts _____                    | 11      |
| Air Cleaner Rods _____                     | 11      |
| Air Cleaner Service Decals _____           | 35      |
| Air Ride Suspension _____                  | 102     |
| Alternator Brackets (Aftermarket) _____    | 6-9     |
| Alternator Brackets (Factory) _____        | 11      |
| Aluminum Radiators _____                   | 88      |
| Antenna Bases _____                        | 88      |
| Antenna Gaskets _____                      | 88      |
| Antenna Nuts _____                         | 88      |
| Antenna Parts _____                        | 88      |
| Antennas _____                             | 88      |
| Armrest Bases _____                        | 11      |
| Armrest Pads _____                         | 11      |
| Armrest Parts _____                        | 11-12   |
| Armrest Trim _____                         | 12      |
| Ash Trays _____                            | 12      |
| Assembly Manuals _____                     | 73      |
| Axle Bearings _____                        | 101     |
| Axle Bumpers _____                         | 101     |

## B

|                                    |     |
|------------------------------------|-----|
| Back Glass _____                   | 120 |
| Back Glass Drain Tubes _____       | 113 |
| Back Glass Molding Clip Sets _____ | 21  |
| Back Glass Moldings _____          | 74  |
| Back Glass to Trunk Panels _____   | 96  |
| Back Glass Seals _____             | 113 |
| Backup Light Lens Trim _____       | 62  |

## C

|                                  |         |   |         |
|----------------------------------|---------|---|---------|
| Backup Light Lenses _____        | 62      | Center Links _____                      | 100     |
| Backup Light Parts _____         | 62      | Choke Tubes _____                       | 21      |
| Backup Light Switches _____      | 106     | Chrome Bumpers _____                    | 18      |
| Ball Joints _____                | 99      | Chrome Window Frames _____              | 120     |
| Basic Weather Strip Kits _____   | 111     | Cigarette Lighters _____                | 21      |
| Batter Holddowns _____           | 12      | Classic Instrument Gauges _____         | 30      |
| Battery Cable Clip _____         | 12      | Classic Update Wiring Kits _____        | 133     |
| Battery Decals _____             | 36      | Clips Sets _____                        | 21-22   |
| Battery Mat _____                | 12      | Clock Face Lens _____                   | 22      |
| Battery Parts _____              | 12      | Clock Knobs _____                       | 22      |
| Battery Trays _____              | 12      | Clock Parts _____                       | 22      |
| Bench Seat Consoles _____        | 23      | Clocks _____                            | 22      |
| Billet Hood Hinges _____         | 58      | Clutch Cross Shaft Brackets _____       | 23      |
| Billet Brake Pedals _____        | 72      | Clutch Fork Boots _____                 | 22      |
| Billet Door Handles _____        | 40      | Clutch Forks _____                      | 23      |
| Billet Gas Pedals _____          | 72      | Clutch Linkage _____                    | 23      |
| Billet Pedals _____              | 72      | Clutch Parts _____                      | 22-23   |
| Billet Trunk Hinges _____        | 107     | Clutch Rod Firewall Boot _____          | 22      |
| Blower Motor Switches _____      | 57      | Clutch Rods _____                       | 23      |
| Blower Motors _____              | 57      | Clutch Z-Bars _____                     | 23      |
| Blue Dots _____                  | 64      | Coat Hooks _____                        | 28      |
| Blue Tooth Kits _____            | 86      | Coil Bracket _____                      | 39      |
| Blue Tooth Radios _____          | 87      | Coil Over Conversions _____             | 100     |
| Body Bumper Kits _____           | 19      | Coil Over Suspension Kits _____         | 102     |
| Body Mount Bolt Kits _____       | 13      | Coil Springs _____                      | 101     |
| Body Mounts _____                | 13      | Column Shift Levers _____               | 97      |
| Books _____                      | 72-73   | Complete Lock Sets _____                | 70      |
| Booster Kits _____               | 16      | Complete Glass Sets _____               | 121-122 |
| Brake Booster Check Valves _____ | 14      | Compressor Brackets (Aftermarket) _____ | 6-9     |
| Brake Booster Kits _____         | 16      | Compressor Decals _____                 | 35      |
| Brake Cables _____               | 17      | Compressor Switches _____               | 10      |
| Brake Hardware Kits _____        | 14      | Compressors _____                       | 3       |
| Brake Hoses _____                | 14      | Condensers _____                        | 4       |
| Brake Hydro Boosters _____       | 15      | Console Assemblies _____                | 23      |
| Brake Junction Blocks _____      | 14      | Console Base _____                      | 24      |
| Brake Lines _____                | 17      | Console Clock Lens _____                | 24      |
| Brake Master Cylinders _____     | 15      | Console Emblems _____                   | 24      |
| Brake Parts _____                | 13-17   | Console Harnesses _____                 | 130     |
| Brake Pedals _____               | 13      | Console Light Lenses _____              | 24      |
| Brake Shoes _____                | 13      | Console Locks _____                     | 24      |
| Brake Stop Light Switches _____  | 13      | Console Parts _____                     | 23-24   |
| Brake Wheel Cylinders _____      | 15      | Console Shift Plates _____              | 24      |
| Bulk Heads _____                 | 4       | Console Slider _____                    | 24      |
| Bumper Bolt Kits _____           | 19      | Console Trim Parts _____                | 24      |
| Bumper Braces _____              | 18      | Console Tunnel Extension Seal _____     | 24      |
| Bumper Filler Panels _____       | 18      | Continental Kit Seals _____             | 28      |
| Bumper Guards _____              | 18      | Control Arms _____                      | 100-101 |
| Bumper Parts (Chrome) _____      | 18-19   | Control Arm Bumpers _____               | 100     |
| Bumper to Body Seals _____       | 19      | Control Arm Bushings _____              | 101     |
| Bumpers (Chrome) _____           | 18      | Control Arm Shafts _____                | 100     |
| Bumpers (Rubber) _____           | 19-20   | Convertible Top Boot Snaps _____        | 28      |
| Carburetor Linkage _____         | 20      | Convertible Top Boot Sliders _____      | 25      |
| Carpet _____                     | 137-139 | Convertible Top Boots _____             | 26-27   |
| Carpet Thresholds _____          | 99      | Convertible Top Cylinders _____         | 25      |
| Cat Whiskers _____               | 114-115 | Convertible Top Handles _____           | 24      |
| CD Changers _____                | 86      | Convertible Top Header Bow _____        | 25      |
|                                  |         | Convertible Top Holddown Cables _____   | 25      |

## Table of Contents

|  |         |                                      |                         |                                       |                                 |    |
|--|---------|--------------------------------------|-------------------------|---------------------------------------|---------------------------------|----|
| Convertible Top Hoses _____            | 25      | Door Handle Guards _____             | 40                      | <b>F</b>                              |                                 |    |
| Convertible Top Latches _____          | 24      | Door Handle Mechanisms _____         | 40                      | Fan Shrouds _____                     | 85                              |    |
| Convertible Top Motors _____           | 25      | Door Handles _____                   | 40-41                   | Felt Kits _____                       | 114-115                         |    |
| Convertible Top Parts _____            | 24-28   | Door Hinge Pin Kit _____             | 39                      | Fender Emblems _____                  | 45-46                           |    |
| Convertible Top Pumps _____            | 25      | Door Hinges _____                    | 39                      | Fender Eyebrow Moldings _____         | 77-80                           |    |
| Convertible Top Switches _____         | 25      | Door J-Seals _____                   | 41                      | Fender Letters _____                  | 46                              |    |
| Convertible Top Weatherstripping _____ | 25      | Door Latch Mechanisms _____          | 42                      | Fender Moldings _____                 | 75-78                           |    |
| Convertible Top Well Liners _____      | 26      | Door Latch's _____                   | 42                      | Fender Patch Panels _____             | 91                              |    |
| Convertible Tops _____                 | 26      | Door Lock Knobs _____                | 41                      | Fender Scripts _____                  | 46                              |    |
| Cooling System Decals _____            | 36      | Door Locks _____                     | 40                      | Fender Seals _____                    | 47                              |    |
| Copper Radiators _____                 | 83-84   | Door Molding Clip Set _____          | 22                      | Fender Skirt Hardware _____           | 47                              |    |
| Core Support Mounts _____              | 82      | Door Moldings _____                  | 75-78                   | Fender Skirt Parts _____              | 47-48                           |    |
| Core Supports _____                    | 82      | Door Panel Cardboard _____           | 28                      | Fender Skirt Scuff Pads _____         | 48                              |    |
| Corner Light Parts _____               | 64      | Door Panel Emblems _____             | 43                      | Fender Skirt Seals _____              | 47                              |    |
| Cowl Seals _____                       | 28      | Door Panel Medallions _____          | 43                      | Fenders _____                         | 91                              |    |
| Crank Case Vent Hose _____             | 28      | Door Panel Retainer Plugs _____      | 21                      | Fener Anti-Squeak Seals _____         | 47                              |    |
| Crank Shaft Pulleys _____              | 47      | Door Panel Watershields Sets _____   | 29                      | Fener Molding Clip Set _____          | 22                              |    |
| Cruise Control Tag _____               | 37      | Door Panels _____                    | 155-163                 | Fin Molding Clip Set _____            | 22                              |    |
| Custom Consoles _____                  | 23      | Door Parts _____                     | 35-43                   | Firewall Pads _____                   | 48                              |    |
| <b>D</b>                               |         |                                      | Door Rubber Seals _____ | 42                                    | Flashers _____                  | 65 |
| Dakota Digital Gauges _____            | 32-33   | Door Sill Plates _____               | 99                      | Floor Mats _____                      | 48                              |    |
| Dash Ash Trays _____                   | 12      | Door Skins _____                     | 91                      | Floor Pan Assemblies _____            | 94                              |    |
| Dash Bezels _____                      | 34      | Door Striker Plates _____            | 42                      | Floor Pan Braces _____                | 96-97                           |    |
| Dash Clocks _____                      | 29      | Door Window Adjustment Plates _____  | 110                     | Floor Pan Plugs _____                 | 19                              |    |
| Dash Detail Kit _____                  | 34      | Door Window Frames _____             | 120                     | Floor Pans _____                      | 92-94                           |    |
| Dash Emblems _____                     | 44      | Door Window Glass _____              | 121                     | Floor Shifter Boots _____             | 49                              |    |
| Dash Fascia Trim _____                 | 34      | Door Window Handles _____            | 110-111                 | Floor Shifter Conversions _____       | 106                             |    |
| Dash Harnesses _____                   | 128-130 | Doors _____                          | 91                      | Floor Shifter Knobs _____             | 49                              |    |
| Dash Pads _____                        | 34      | Drive Shaft Support _____            | 101                     | Floor Shifter Parts _____             | 48-49                           |    |
| Dash Parts _____                       | 29-34   | Drop Spindles _____                  | 14                      | Floor Shifters (Lokar) _____          | 71                              |    |
| Dash Scripts _____                     | 46      | <b>E</b>                             |                         |                                       | Fly Wheel Cover Extension _____ | 47 |
| Dash Seals _____                       | 34      | Electric Fans _____                  | 85                      | Fly Wheel Parts _____                 | 47                              |    |
| Dash Shift Indicators _____            | 31      | Emblems _____                        | 43-47                   | Fresh Air Vent Assemblies _____       | 57                              |    |
| Dash Tach Housing Seal _____           | 34      | Emergency Brake Linkage Parts _____  | 17                      | Fresh Air Vent Pull Knobs _____       | 56                              |    |
| Dash Tach Kit _____                    | 34      | Emergency Brake _____                |                         | Front Antennas _____                  | 88                              |    |
| Dash Trim _____                        | 34      | Pedal Assemblies _____               | 17                      | Front Brake Cables _____              | 17                              |    |
| Decals _____                           | 35-39   | Emergency Brake Pedal Parts _____    | 17                      | Front Brake Hoses _____               | 14                              |    |
| Deluxe Weather Strip Kits _____        | 117-118 | Emergency Brake _____                |                         | Front Brake Lines _____               | 17                              |    |
| Digital Gauges _____                   | 32-33   | Release Handles _____                | 17                      | Front Brake Shoes _____               | 13                              |    |
| Dimmer Switches _____                  | 55      | Emergency Brake Cable Clips _____    | 17                      | Front Bumper Bolt Kits _____          | 19                              |    |
| Disc Brake Conversion Brackets _____   | 14      | Emergency Brake Cables _____         | 17                      | Front Bumper Braces _____             | 18                              |    |
| Disc Brake Conversion Kits _____       | 14-16   | Emission Decals _____                | 36                      | Front Bumper Guards _____             | 18                              |    |
| Distributor Holddown Brackets _____    | 39      | Engine Brackets (Aftermarket) _____  | 6-9                     | Front Bumpers _____                   | 18                              |    |
| Distributor Parts _____                | 39      | Engine Dipsticks (Lokar) _____       | 71                      | Front Coil Over Conversions _____     | 100                             |    |
| Distributor Vacuum Lines _____         | 39      | Engine Harnesses _____               | 125-126                 | Front Coil Springs _____              | 101                             |    |
| Division Bar Channels _____            | 111     | Engine Install Kits _____            | 74                      | Front Fenders _____                   | 91                              |    |
| Dome Light Assemblies _____            | 39      | Engine Mount Cushions _____          | 74                      | Front Floor Pans _____                | 92-94                           |    |
| Dome Light Bezels _____                | 39      | Engine Mount to Frame Brackets _____ | 74                      | Front Light Harnesses _____           | 127-128                         |    |
| Dome Light Harnesses _____             | 124     | Engine Mounts _____                  | 74                      | Front Quarter Panel Sections _____    | 92                              |    |
| Dome Light Lenses _____                | 39      | Engine Pulleys _____                 | 47                      | Front Runner Drive Systems _____      | 9                               |    |
| Dome Light Parts _____                 | 39      | Evaporator Box Decals _____          | 36                      | Front Sheet Metal Fastener Kits _____ | 103                             |    |
| Dome Light Switches _____              | 39      | Exhaust Hangers _____                | 47                      | Front Shocks _____                    | 100                             |    |
| Door Bumpers _____                     | 43      | Exhaust Parts _____                  | 47                      | Front Sway Bars _____                 | 101                             |    |
| Door Drain Seals _____                 | 42      | Exhaust Ports _____                  | 47                      | Fuel Caps _____                       | 51                              |    |
| Door Glass Assemblies _____            | 121     | Exterior Screw Sets _____            | 104                     | Fuel Door Guards _____                | 50                              |    |
| Door Glass to Vent Stops _____         | 111     | Eyebrow Molding Clip Set _____       | 22                      | Fuel Doors _____                      | 50                              |    |
| Door Handle Gaskets _____              | 40      |                                      |                         | Fuel Filter Assemblies _____          | 51                              |    |
|  |         |                                      |                         | Fuel Gauge Face Lens _____            | 29                              |    |

# Table of Contents

|                                      |         |                                      |         |                                     |         |
|--------------------------------------|---------|--------------------------------------|---------|-------------------------------------|---------|
| Fuel Gauges _____                    | 29      | Grille Screens _____                 | 54      | Hoods _____                         | 91      |
| Fuel Lines _____                     | 49      | Grille Teeth _____                   | 54      | Horn Button Emblems _____           | 44      |
| Fuel Link _____                      | 31      | Grilles _____                        | 53      | Horn Buttons _____                  | 59      |
| Fuel Pump to Carburetor Lines _____  | 49      | Grommets _____                       | 54      | Horn Contact Parts _____            | 59      |
| Fuel Tank Filler Neck Grommets _____ | 49      | Ground Strap Kits _____              | 88      | Horn Contact Repair Kit _____       | 59      |
| Fuel Tank Filler Neck Hose _____     | 50      |                                      |         | Horn Parts _____                    | 59-60   |
| Fuel Tank Filler Necks _____         | 50      | <b>H</b>                             |         | Horn Relays _____                   | 60      |
| Fuel Tank Parts _____                | 49-51   | Handles _____                        | 60-61   | Horn Ring Spacers _____             | 59      |
| Fuel Tank Sending Unit Parts _____   | 51      | Headlight Adjuster Kits _____        | 55      | Horn Rings _____                    | 59      |
| Fuel Tank Sending Units _____        | 51      | Headlight Bezel Retaining Clip _____ | 55      | Horns _____                         | 59      |
| Fuel Tank Straps _____               | 51      | Headlight Bezels _____               | 55      | Hub Cap Decals _____                | 109     |
| Fuel Tanks _____                     | 50      | Headlight Buckets _____              | 54      | Hub Dust Covers _____               | 103     |
| Full Glass Sets _____                | 121-122 | Headlight Bulbs _____                | 55      | HushMat _____                       | 135     |
| Full Quarter Panels _____            | 94      | Headlight Caps _____                 | 90      | Hydro Boost Systems _____           | 15      |
|                                      |         | Headlight Dimmer Switches _____      | 55      |                                     |         |
|                                      |         | Headlight Knob & Shafts _____        | 55      | <b>I</b>                            |         |
|                                      |         | Headlight Mounting Cups _____        | 55      | Ididit Steering Columns _____       | 135     |
|                                      |         | Headlight Parts _____                | 54-55   | Idler Arms _____                    | 100     |
|                                      |         | Headlight Retaining Rings _____      | 54      | Ignition Key & Tumblers _____       | 61      |
|                                      |         | Headlight Switches _____             | 54      | Ignition Switches _____             | 61      |
|                                      |         | Headliner Bows _____                 | 168     | Ignition Wire Hardware _____        | 61      |
|                                      |         | Headliner Moldings _____             | 166     | Ignition Wire Shields _____         | 61      |
|                                      |         | Headliner Trim _____                 | 166     | Ignition Conversion Kits _____      | 62      |
|                                      |         | Headliners _____                     | 164-165 | Inner Rocker Panels _____           | 92      |
|                                      |         | Heat Insulation _____                | 135     | Inner Door Bottoms _____            | 91      |
|                                      |         | Heater Blower Motor Switches _____   | 57      | Inner Fender Bolt Kits _____        | 91      |
|                                      |         | Heater Blower Motors _____           | 57      | Inner Fender Extensions _____       | 91      |
|                                      |         | Heater Control Cables _____          | 56      | Inner Fender Seals _____            | 47      |
|                                      |         | Heater Control Face Lens _____       | 56      | Inner Fenders _____                 | 91      |
|                                      |         | Heater Control Knobs _____           | 56      | Inner Tie Rod Ends _____            | 99      |
|                                      |         | Heater Control Levers _____          | 56      | Inner Wheel Bearings _____          | 103     |
|                                      |         | Heater Control Switches _____        | 57      | Inner Wheel Houses _____            | 94      |
|                                      |         | Heater Cores _____                   | 56      | Inside Door Handle Mechanisms _____ | 40      |
|                                      |         | Heater Duct Hose _____               | 56      | Inside Door Handles _____           | 40      |
|                                      |         | Heater Hose Clamps _____             | 56      | Inside Mirror Brackets _____        | 74      |
|                                      |         | Heater Hoses _____                   | 56      | Inside Mirror Parts _____           | 74      |
|                                      |         | Heater Parts _____                   | 55-57   | Inside Mirrors _____                | 74      |
|                                      |         | Heater Resistors _____               | 55      | Instructional Books _____           | 73      |
|                                      |         | Heater Seals _____                   | 56      | Insulation _____                    | 135     |
|                                      |         | Heater Switches _____                | 57      | Insulator _____                     | 135     |
|                                      |         | Heater Valves _____                  | 57      | Interior _____                      | 137-175 |
|                                      |         | HDX Gauge Kits _____                 | 33      | Interior Screw Sets _____           | 104     |
|                                      |         | Highway Series Wiring Kits _____     | 134     | Intermediate Brake Cables _____     | 17      |
|                                      |         | Hog Rings _____                      | 90      |                                     |         |
|                                      |         | Hood Bumpers _____                   | 58      | <b>J</b>                            |         |
|                                      |         | Hood Emblems _____                   | 46      | Jack Instructions _____             | 38      |
|                                      |         | Hood Hinge Springs _____             | 58      | J-Seals _____                       | 41      |
|                                      |         | Hood Hinges _____                    | 58      |                                     |         |
|                                      |         | Hood Insulation _____                | 57      | <b>K</b>                            |         |
|                                      |         | Hood Latch Supports _____            | 58      | Keyless Entry Systems _____         | 41      |
|                                      |         | Hood Latches _____                   | 58      | Kick Down Cables (Lokar) _____      | 71      |
|                                      |         | Hood Letters _____                   | 46      | Kick Panel Speakers _____           | 85      |
|                                      |         | Hood Lip Moldings _____              | 57      | Kick Panels _____                   | 175     |
|                                      |         | Hood Parts _____                     | 57-58   |                                     |         |
|                                      |         | Hood Scripts _____                   | 46      | <b>L</b>                            |         |
|                                      |         | Hood Side Bumpers _____              | 58      | LED Headlight Bulbs _____           | 55      |
|                                      |         | Hood Stop Kits _____                 | 58      | LED Flashers _____                  | 65      |
|                                      |         | Hood to Cowl Seals _____             | 28      | LED Parklight Lenses _____          | 63      |

## Table of Contents

|                                     |         |                                      |         |                                    |         |
|-------------------------------------|---------|--------------------------------------|---------|------------------------------------|---------|
| Lens Gasket Kits _____              | 67      | Oil Filler Caps _____                | 80      | Quarter Panel Moldings _____       | 75-78   |
| License Light Assemblies _____      | 68      | Oil Filler Tubes _____               | 80      | Quarter Panel Scripts _____        | 46      |
| License Light Gaskets _____         | 68      | Oil Filter Decal _____               | 36      | Quarter Panel Sections _____       | 92-93   |
| License Light Lenses _____          | 68      | Oil Gauge Lens _____                 | 29      | Quarter Panel Skins _____          | 94      |
| License Plate Brackets _____        | 68      | Oil Pressure Sending Units _____     | 80      | Quarter Panel Taillight            |         |
| License Plate Light Parts _____     | 68      | Oil System Decals _____              | 36      | Patch Panel _____                  | 93      |
| License Plate Panel Clip _____      | 22      | Outer Rocker Panels _____            | 92      | Quarter Window Frames _____        | 120     |
| License Plate Panels _____          | 69      | Outer Tie Rod Ends _____             | 99      | Quarter Window Glass _____         | 123     |
| Liftgate Door Seals _____           | 42      | Outer Wheel Bearings _____           | 103     | Quarter Window Handles _____       | 111     |
| Literature _____                    | 72-73   | Outer Wheel Houses _____             | 94      | Quarter Window Moldings _____      | 75      |
| Lock Sets _____                     | 69-70   | Outside Door Handle Gaskets _____    | 40      | Quarter Window Pivot               |         |
| Lokar Parts _____                   | 70-72   | Outside Door Handle Guards _____     | 40      | Assemblies _____                   | 110     |
| Long Brake Lines _____              | 17      | Outside Door Handles _____           | 41      | Quarter Window Seal Retainer       |         |
| Long Fuel Lines _____               | 49      | Outside Mirror Gaskets _____         | 73      | Moldings _____                     | 113     |
| Long Gas Lines _____                | 49      | Outside Mirror Mounting Kits _____   | 73      | Quarter Window Seals _____         | 113     |
| Lower A-Arm Bumpers _____           | 100     | Outside Mirrors _____                | 73      | Quarter Window Stops _____         | 112     |
| Lower A-Arm Bushings _____          | 100     | Overflow Tanks _____                 | 82      | Quarter Window Track               |         |
| Lower A-Arm Shafts _____            | 100     | Owners Manuals _____                 | 73      | Reline Kit _____                   | 110     |
| Lower A-Arms _____                  | 100-101 |                                      |         |                                    |         |
| Lower Ball Joints _____             | 99      | <b>P</b>                             |         | <b>R</b>                           |         |
| Lower Control Arm Bumpers _____     | 100     | Package Trays _____                  | 175     | Radiator Bug Screens _____         | 81      |
| Lower Control Arm Bushings _____    | 101     | Padded Dashes _____                  | 34      | Radiator Caps _____                | 81      |
| Lower Control Arm Shafts _____      | 100     | Panhard Bars _____                   | 103     | Radiator Core Support Mounts _____ | 82      |
| Lower Control Arms _____            | 100-101 | Parking Brake Cables _____           | 17      | Radiator Core Supports _____       | 82      |
| Lower Door Drain Seals _____        | 42      | Parklight Assemblies _____           | 62      | Radiator Fan Shrouds _____         | 85      |
| Lower Door Hinges _____             | 39      | Parklight Housings _____             | 63      | Radiator Hoses _____               | 81-82   |
| Lower Flywheel Cover _____          | 47      | Parklight Lens Gaskets _____         | 63      | Radiator Overflow Tanks _____      | 82      |
| Lower Glass Channel _____           | 109     | Parklight Lenses _____               | 63      | Radiator Parts _____               | 81-85   |
| Lower Radiator Hoses _____          | 81      | Parklight Parts _____                | 62-63   | Radiator Petcocks _____            | 81      |
| Lower Trailing Arms _____           | 103     | Passing Gear Linkage Rods _____      | 20      | Radiators _____                    | 8-84    |
| Lower Window Frames _____           | 109     | Pillar Post Seals _____              | 113     | Radio Decals _____                 | 37      |
| LS1 Engine Brackets _____           | 74      | Pinion Seals _____                   | 101     | Radio Ground Strap Kits _____      | 88      |
| LS Engine Install Kits _____        | 74      | Pitch Fork Molding Clip Set _____    | 22      | Radio Knobs _____                  | 8       |
|                                     |         | Pitman Arms _____                    | 99      | Radio Parts _____                  | 85-88   |
|                                     |         | Power Vent Window                    |         | Radios _____                       | 86-87   |
| <b>M</b>                            |         | Conversion Kits _____                | 118-119 | Rag Joint Rebuild Kits _____       | 98      |
| Manuals _____                       | 72-73   | Power Brake Booster Kits _____       | 16      | Rear Antennas _____                | 88      |
| Mark-IV AC Systems _____            | 4       | Power Steering Boxes _____           | 80      | Rear Ash Trays _____               | 12      |
| Master Cylinders _____              | 15      | Power Steering Control Valves _____  | 80      | Rear Body Emblems _____            | 44      |
| Mirror Gaskets _____                | 73      | Power Steering Conversion Kits _____ | 81      | Rear Body Harnesses _____          | 130-132 |
| Mirror Mounting Kits _____          | 73      | Power Steering Hoses _____           | 80-81   | Rear Brake Cables _____            | 17      |
| Mirror Parts _____                  | 73-74   | Power Steering Parts _____           | 80-81   | Rear Brake Hoses _____             | 14      |
| Moldings _____                      | 75-80   | Power Steering Pump Brackets _____   | 80      | Rear Brake Lines _____             | 17      |
| Motor Mount Cushions _____          | 74      | Power Steering Pumps                 |         | Rear Brake Shoes _____             | 13      |
| Motor Mount to Frame Brackets _____ | 74      | (Front Runner) _____                 | 7       | Rear Bumper Bolt Kits _____        | 19      |
| Motor Mounts _____                  | 74      | Power Steering Slave Cylinders _____ | 80      | Rear Bumper Braces _____           | 18      |
| Muffler Hangers _____               | 47      | Power Window Conversion Kits _____   | 115     | Rear Bumper Guards _____           | 18      |
|                                     |         | Proportioning Valves _____           | 15      | Rear Bumper to Body Seals _____    | 19      |
|                                     |         | Pro-touring Kits _____               | 99      | Rear Bumpers _____                 | 18      |
|                                     |         | Pulleys _____                        | 47      | Rear Coil Springs _____            | 101     |
|                                     |         |                                      |         | Rear Disc Brake Parts _____        | 16      |
|                                     |         | <b>Q</b>                             |         | Rear Floor Pans _____              | 92-94   |
|                                     |         | Quarter Panels _____                 | 94      | Rear Glass Drain Tubes _____       | 113     |
|                                     |         | Quarter Panel Boards _____           | 28      | Rear Glass Moldings _____          | 75      |
|                                     |         | Quarter Panel Emblems _____          | 44      | Rear Quarter Panel Sections _____  | 93      |
|                                     |         | Quarter Panel Extension Seals _____  | 47      | Rear Shocks _____                  | 103     |
|                                     |         | Quarter Panel Letters _____          | 46      | Rear Speaker Grilles _____         | 82      |
|                                     |         | Quarter Panel Molding Clip Set _____ | 22      | Rear Suspension Bushings _____     | 101     |

## Table of Contents

|                                 |       |                                    |         |                                      |         |
|---------------------------------|-------|------------------------------------|---------|--------------------------------------|---------|
| Rear Sway Bars _____            | 103   | SS Trim Molding Inserts _____      | 76-78   | Top Parts _____                      | 24-28   |
| Rear View Mirror Parts _____    | 74    | Starter Ignition Harnesses _____   | 125-126 | Top Pumps _____                      | 25      |
| Rear Wheel Wells _____          | 94    | Steering Column Bearing _____      | 98      | Top Switches _____                   | 25      |
| Rear Window Glass _____         | 120   | Steering Column Parts _____        | 97-98   | Top Weatherstripping _____           | 25      |
| Remote Mirror Pivot Plate _____ | 73    | Steering Column Seals _____        | 98      | Top Well Liners _____                | 26      |
| Ridetech Suspension _____       | 102   | Steering Column Shift Levers _____ | 97      | Tops _____                           | 25      |
| Rocker Molding Clip Set _____   | 22    | Steering Wheel Adapters _____      | 136     | Traffic Light Viewer _____           | 106     |
| Rocker Panel Moldings _____     | 75-80 | Steering Wheel Shrouds _____       | 97      | Trailing Arm Bushings _____          | 101     |
| Rocker Panels _____             | 92    | Steering Wheel Trim _____          | 98      | Trailing Arms _____                  | 103     |
| Roof Panel Emblems _____        | 46    | Steering Wheels _____              | 98      | Transmission Crossmembers _____      | 106     |
| Roofrail Weatherstripping _____ | 89    | Stock Spindles _____               | 14      | Transmission Dipsticks (Lokar) _____ | 71      |
| Rubber Bumpers _____            | 19-20 | Stop Light Switches _____          | 14      | Transmission Hump Consoles _____     | 23      |
| Rubber Door Bumpers _____       | 43    | Streetgrip Suspension _____        | 102     | Transmission Lines _____             | 105     |
| Rubber Door Seals _____         | 42    | Sunvisor Bracket Sleeves _____     | 99      | Transmission Mounts _____            | 105     |
| Rubber Floor Mats _____         | 48    | Sunvisor Brackets _____            | 99      | Transmission Parts _____             | 105-106 |
| Rubber Grommets _____           | 54    | Sunvisors _____                    | 170-174 | Transmission Shift Indicators _____  | 105     |
| Rubber Seat Stops _____         | 90    | SureFit AC Systems _____           | 1-3     | Trunk Area Divider Panels _____      | 96      |
| Rubber Trunk Seals _____        | 108   | Suspension Parts _____             | 99-103  | Trunk Bumpers _____                  | 107     |

### S

|                                      |         |
|--------------------------------------|---------|
| Sail Panel Boards _____              | 169     |
| Screw Sets _____                     | 104     |
| Seat Adjustment Knobs _____          | 90      |
| Seat Belts _____                     | 89-90   |
| Seat Covers _____                    | 145-155 |
| Seat Foam _____                      | 90      |
| Seat Knobs _____                     | 90      |
| Seat Parts _____                     | 89-90   |
| Seat Stops _____                     | 90      |
| Seat Tracks _____                    | 90      |
| Seat Trim _____                      | 90      |
| Secret Audio Systems _____           | 86      |
| Sheetmetal Body Panels _____         | 90-97   |
| Shift Lever Grommets _____           | 98      |
| Shift Levers _____                   | 97      |
| Shift Linkage _____                  | 105     |
| Shifter Boots _____                  | 49      |
| Shifter Conversions _____            | 106     |
| Shifter Knobs _____                  | 49      |
| Shop Manuals _____                   | 72      |
| Side Glass Sets _____                | 121-122 |
| Side Marker Light Lens Bezels _____  | 64      |
| Side Marker Light Lens Gaskets _____ | 63      |
| Side Marker Light Parts _____        | 63-64   |
| Side Molding Clip Sets _____         | 21      |
| Side Moldings _____                  | 75-80   |
| Side Trim Tape _____                 | 78      |
| Side Window Seals _____              | 113     |
| Sill Plates _____                    | 99      |
| SkyDrive _____                       | 31      |
| Speakers _____                       | 85      |
| Speedometer Cable Grommets _____     | 54      |
| Speedometer Cables (Universal) _____ | 71      |
| Speedometer Gears _____              | 106     |
| Speedometer Housing Seals _____      | 34      |
| Speedometer Lens _____               | 29      |
| Speedometers _____                   | 29      |
| Splash Pan Seals _____               | 48      |

### T

|                                   |         |
|-----------------------------------|---------|
| Tachometer Faces _____            | 34      |
| Tachometer Harnesses _____        | 124     |
| Tachometer Parts _____            | 34      |
| Tailgate Emblems _____            | 43      |
| Tailgate Molding Clip Set _____   | 22      |
| Taillight Assemblies _____        | 66      |
| Taillight Bases _____             | 66      |
| Taillight Bezels _____            | 66      |
| Taillight Harnesses _____         | 130-132 |
| Taillight Housing Seals _____     | 68      |
| Taillight Lens Gaskets _____      | 67      |
| Taillight Lens Kits _____         | 67      |
| Taillight Lenses _____            | 64-67   |
| Taillight Parts _____             | 64-68   |
| Taillight Trim _____              | 68      |
| Tailpan Brace _____               | 96      |
| Tailpans _____                    | 96      |
| Taillight Assembly Seals _____    | 68      |
| Taillight Housings _____          | 66      |
| Temperature Gauge Face Lens _____ | 29      |
| Throttle Cables (Lokar) _____     | 71      |
| Throttle Linkage _____            | 20      |
| Tie Rod End Sleeves _____         | 99      |
| Tie Rod Ends _____                | 99      |
| Tilt Steering Levers _____        | 107     |
| Tire Pressure Decals _____        | 37      |
| Tissue Dispensers _____           | 107     |
| Tools _____                       | 107     |
| Top Boot Sliders _____            | 25      |
| Top Boot Snaps _____              | 28      |
| Top Boots _____                   | 26-27   |
| Top Cylinders _____               | 25      |
| Top Handles _____                 | 24      |
| Top Header Bow _____              | 25      |
| Top Holddown Cables _____         | 25      |
| Top Hoses _____                   | 25      |
| Top Latches _____                 | 24      |
| Top Motors _____                  | 25      |

|                                     |         |
|-------------------------------------|---------|
| Trunk Cardboard Panels _____        | 108     |
| Trunk Cardboard Interior Kits _____ | 108     |
| Trunk Emblems _____                 | 45      |
| Trunk Filler Panels _____           | 95      |
| Trunk Floor Pan Assemblies _____    | 97      |
| Trunk Floor Patch Panels _____      | 95      |
| Trunk Hinges _____                  | 107     |
| Trunk Latches _____                 | 107     |
| Trunk Letters _____                 | 47      |
| Trunk Lids _____                    | 95      |
| Trunk Locks _____                   | 107     |
| Trunk Mats _____                    | 108     |
| Trunk Molding Clip Set _____        | 22      |
| Trunk Moldings _____                | 75-80   |
| Trunk Panels _____                  | 95-96   |
| Trunk Parts _____                   | 107-108 |
| Trunk Rubber Seals _____            | 108     |
| Trunk Scripts _____                 | 45      |
| Trunk Vees _____                    | 47      |
| Tubular A-Arms _____                | 100     |
| Tubular Trac Bars _____             | 103     |
| Tubular Trailing Arms _____         | 103     |
| Turn Signal Cancelling Cams _____   | 108     |
| Turn Signal Levers _____            | 109     |
| Turn Signal Mechanism Cables _____  | 108     |
| Turn Signal Mechanism Cams _____    | 108     |
| Turn Signal Mechanism Parts _____   | 108-109 |
| Turn Signal Parts _____             | 108-109 |

### U

|                                 |         |
|---------------------------------|---------|
| Under Dash Harnesses _____      | 128-130 |
| Under Seat Floor Pans _____     | 92-93   |
| Upper A-Arm Bumpers _____       | 100     |
| Upper A-Arm Bushings _____      | 101     |
| Upper A-Arm Shafts _____        | 100     |
| Upper A-Arms _____              | 100-101 |
| Upper Ball Joints _____         | 99      |
| Upper Clutch Rods _____         | 23      |
| Upper Control Arm Bumpers _____ | 100     |

## Table of Contents

|                                     |         |                                     |     |
|-------------------------------------|---------|-------------------------------------|-----|
| Upper Control Arm Bushings _____    | 101     | Windshield Washer Decals _____      | 35  |
| Upper Control Arm Shafts _____      | 100     | Windshield Washer Hoses _____       | 124 |
| Upper Control Arms _____            | 100-101 | Windshield Washer Jar Bracket _____ | 124 |
| Upper Door Hinges _____             | 39      | Windshield Washer Jars _____        | 124 |
| Upper Radiator Hoses _____          | 82      | Windshields _____                   | 122 |
| Upper Window U-Channels _____       | 112     | Wiper Arms _____                    | 123 |
| Urethane A-Arm Bushings _____       | 101     | Wiper Bezels _____                  | 123 |
| Urethane Control Arm Bushings _____ | 101     | Wiper Blades _____                  | 123 |

### V

|                                  |     |                                 |         |
|----------------------------------|-----|---------------------------------|---------|
| Valve Cover Decals _____         | 38  | Wiper Escutcheons _____         | 123     |
| Vanity Mirrors _____             | 74  | Wiper Knobs _____               | 123     |
| Vent Louvers _____               | 4   | Wiper Motor Seals _____         | 123     |
| Vent Pull Knobs _____            | 56  | Wiper Parts _____               | 123-124 |
| Vent Window Assembly Stops _____ | 111 | Wiper Switches _____            | 123     |
| Vent Window Glass _____          | 120 | Windshield Washer Nozzles _____ | 123     |
| Vent Window Handles _____        | 110 | Wire Harness Sill Covers _____  | 99      |
| Vent Window Regulators _____     | 110 | Wiring _____                    | 124-134 |
| Vent Window Rubber Seals _____   | 110 | Wiring Diagrams _____           | 73      |
| VHX Gauges _____                 | 32  | Wiring Kits _____               | 133-134 |
| Vintage Air Front                |     | Wood Wheel Hubs _____           | 97      |
| Runner Systems _____             | 9   | Wood Wheel Mounting Kits _____  | 97      |
| Vintage Air Systems _____        | 1-5 |                                 |         |

### Z

|              |    |
|--------------|----|
| Z-Bars _____ | 23 |
|--------------|----|

### W

|                                       |         |
|---------------------------------------|---------|
| Washer Jar Reservoir Bottle Kit _____ | 124     |
| Water Pump Pulleys _____              | 47      |
| Watershields Sets _____               | 29      |
| Weatherstrip Kits _____               | 116-118 |
| Wheal Bearings _____                  | 103     |
| Wheel Cover Emblems _____             | 109     |
| Wheel Cylinders _____                 | 15      |
| Wheel Houses _____                    | 94      |
| Wheel House Bracings _____            | 94      |
| Wheel Opening Patch Panels _____      | 94      |
| Wheel Seals _____                     | 103     |
| Wheel Spinners _____                  | 109     |
| Wheel Well Moldings _____             | 75-80   |
| Wheel Wells _____                     | 94      |
| Windlace _____                        | 174     |
| Window AC Decals _____                | 37      |
| Window Adjustment Plates _____        | 110     |
| Window Belt Moldings _____            | 112     |
| Window Channel Kits _____             | 112     |
| Window Division Bar Channels _____    | 111     |
| Window Drain Seals _____              | 113     |
| Window Felt Kits _____                | 114-115 |
| Window Frames (Chrome) _____          | 120     |
| Window Handles _____                  | 110-111 |
| Window Parts _____                    | 109-123 |
| Window Price Stickers _____           | 37      |
| Window Regulators _____               | 110     |
| Window Stops _____                    | 112     |
| Windshield Drain Tubes _____          | 113     |
| Windshield Molding Clip Sets _____    | 21      |
| Windshield Moldings _____             | 74      |
| Windshield Pillar Post Seals _____    | 113     |
| Windshield Seals _____                | 114     |



# ALL ROADS LEAD TO H&H

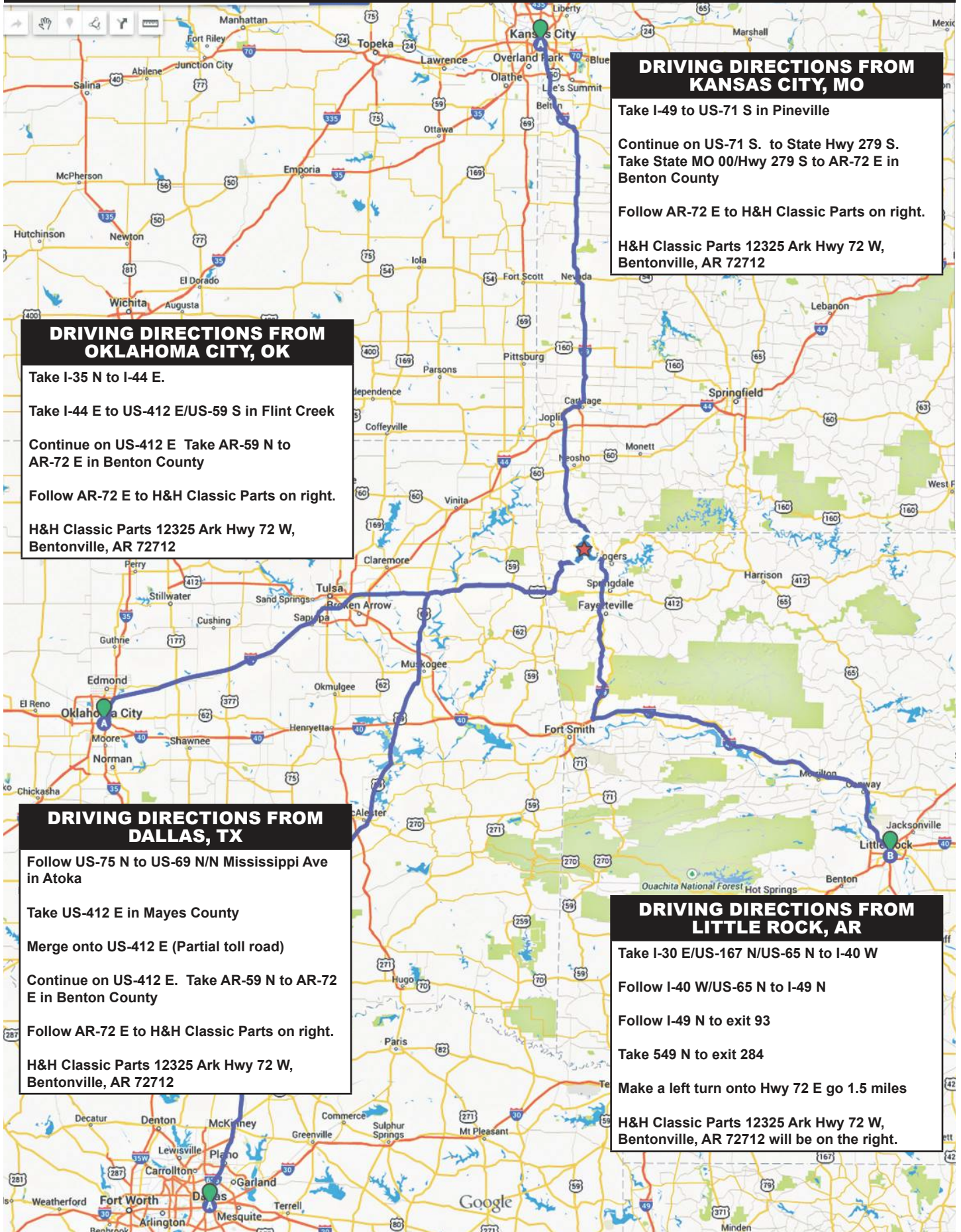

## DRIVING DIRECTIONS FROM KANSAS CITY, MO

Take I-49 to US-71 S in Pineville

Continue on US-71 S. to State Hwy 279 S.  
Take State MO 00/Hwy 279 S to AR-72 E in Benton County

Follow AR-72 E to H&H Classic Parts on right.

H&H Classic Parts 12325 Ark Hwy 72 W,  
Bentonville, AR 72712

## DRIVING DIRECTIONS FROM OKLAHOMA CITY, OK

Take I-35 N to I-44 E.

Take I-44 E to US-412 E/US-59 S in Flint Creek

Continue on US-412 E Take AR-59 N to  
AR-72 E in Benton County

Follow AR-72 E to H&H Classic Parts on right.

H&H Classic Parts 12325 Ark Hwy 72 W,  
Bentonville, AR 72712

## DRIVING DIRECTIONS FROM DALLAS, TX

Follow US-75 N to US-69 N/N Mississippi Ave  
in Atoka

Take US-412 E in Mayes County

Merge onto US-412 E (Partial toll road)

Continue on US-412 E. Take AR-59 N to AR-72  
E in Benton County

Follow AR-72 E to H&H Classic Parts on right.

H&H Classic Parts 12325 Ark Hwy 72 W,  
Bentonville, AR 72712

## DRIVING DIRECTIONS FROM LITTLE ROCK, AR

Take I-30 E/US-167 N/US-65 N to I-40 W

Follow I-40 W/US-65 N to I-49 N

Follow I-49 N to exit 93

Take 549 N to exit 284

Make a left turn onto Hwy 72 E go 1.5 miles

H&H Classic Parts 12325 Ark Hwy 72 W,  
Bentonville, AR 72712 will be on the right.

# You've Got The Ride, We've Got The Parts! Working on more than one car? Check out our other catalogs!

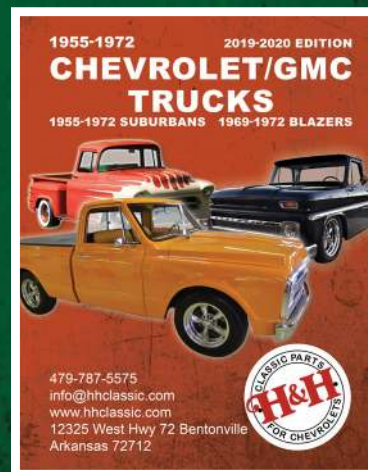
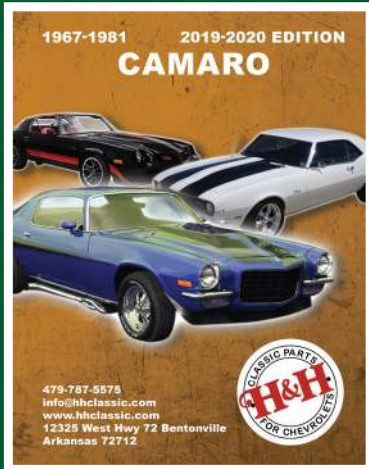

**479-787-5575**  
**info@hhclassic.com**  
**www.hhclassic.com**  
**12325 West Hwy 72 Bentonville**  
**Arkansas 72712**



## WARNING



PRODUCTS SHOWN IN THIS CATALOG CAN EXPOSE YOU TO CERTAIN CHEMICALS, WHICH ARE KNOWN TO THE STATE OF CALIFORNIA TO CAUSE CANCER OR BIRTH DEFECTS OR OTHER REPRODUCTIVE HARM. FOR MORE INFORMATION GO TO:

[www.P65Warnings.ca.gov](http://www.P65Warnings.ca.gov)

Customer #