

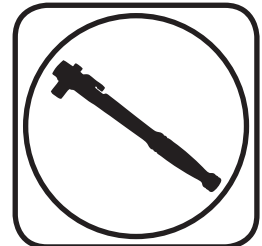

Part # 11245010/11245110 - 1968-1972 GM A-Body StreetGrip

Front Components	
11249590	Delrin Control Arm Bushings
90000894	Tall Upper Balljoint
11242350/11245110	Front Dual Rate CoilSprings
22149846	Front HQ Series Shocks
11249120	Front SwayBar
Rear Components	
57128265	Rear Dual Rate CoilSprings
22189853	Rear HQ Series Shocks
11229122	Rear SwayBar

Recommended Tools



1968-1972 GM A-Body Street Grip Installation Instructions

Table of contents	
Page 2.....	Major components and Hardware List
Page 3.....	Getting Started
Page 4-6.....	Delrin Bushings
Page 7-8.....	Tall Upper Balljoint
Page 9.....	Front Dual Rate CoilSpring
Page 10-13.....	Front SwayBar
Page 14.....	Rear Dual Rate CoilSpring
Page 15-18.....	Front and Rear HQ Series Shocks
Page 19-21.....	Rear SwayBar

The majority of the StreetGrip components will be installed together. For example, the Front CoilSprings, Balljoint, Control Arm Bushings and Shocks will be installed in conjunction with each other. On the rear, the CoilSprings and Shocks will be installed in conjunction with each other. The Sway Bars will, typically, be installed after the rest of the components are installed.



Major ComponentsIn the box

Part #	Description	QTY
55450700/55520750	Front CoilSprings - Small Block/Big Block	2
57128265	Rear CoilSprings	2
90000894	Tall Upper Balljoint	2
90000898	Lower Balljoint	2
90002514	Delrin Bushing Outer Shell - Upper Control Arm	4
90002515	Delrin Bushing Outer Shell - Upper Control Arm	2
90002516	Delrin Bushing Outer Shell - Upper Control Arm	2
70012395	Delrin Bushing - Upper Control Arm	4
70012397	Delrin Bushing - Lower Control Arm	2
70012396	Delrin Bushing - Lower Control Arm	2
Front Shocks		
22849999	4.75" Stroke Stud Top Shock	2
70011139	5/8" ID Shock Bushing (Installed in Shock)	2
90002069	Standard T-Bar (Installed in Shock)	2
70011140	Stud Top Bushing	4
70011141	Stud Top Bushing Washer	4
99372006	3/8"-24 Jam Nut	4
Rear Shocks		
22989999	7.55" Stroke Eye Top Shock	2
70011139	5/8" ID Shock Bushing (Installed in Shock)	2
70011138	3/4" ID Shock Bushing (Installed in Shock)	2
90002068	Wide T-Bar (Installed in Shock)	2
90002103	5/8" ID Shock Sleeve (Installed in Shock)	2
90001619	Cantilever Pin	2
90000471	Cantilever Pin Spacer	2
11249120	Front Swaybar Kit	1
11229122	Rear Swaybar Kit	1
99501006	1/2"-13 x 3 1/2" Hex Bolt - Lower Control Arm	4
99502009	1/2"-13 Nylok Nut - Lower Control Arm	4



Installation Instructions



Getting Started.....

Congratulations on your purchase of the Ridetech StreetGrip Kit. This system has been designed to give your Car excellent ride and handling along with a lifetime of enjoyment. Some of the key features of this Kit: Dual Rate CoilSprings, Delrin Control Arm Bushings, Larger Swaybars with Delrin Liners and a Taller Upper Balljoint.

The majority of the StreetGrip Components will be installed together. For example, the Front CoilSprings, Balljoint, Control Arm Bushings and Shocks will be installed in conjunction with each other. On the rear, the CoilSprings and Shocks will be installed in conjunction with each other. The Sway Bars will, typically, be installed after the rest of the components are installed.

Hardware Kit#99010063

The StreetGrip Kit is supplied with a hardware kit. This hardware kit contains individual bags for the different kits within the main kit. The bags are labeled to help determine the correct hardware for the installation of the specific kits. The instructions will aid you in selecting the correct hardware for each component. The bags included in this kit are:

- Front Sway Bar Kit
- Control Arm Kit
- Rear Sway Bar Kit

Front Suspension

The front components that will need to be installed are: Control Arm Bushings, Upper Ball Joints, Shocks, and CoilSprings. The SwayBar can be installed anytime after the rest of the front suspension is complete.

If you have never done this type of work before, we recommend getting a Factory Service Manual for proper procedures of disassembly and reassembly of the components for your car.

Rear Suspension

The rear components that will be installed are; rear Dual Rate CoilSprings, and rear HQ Series Shocks. The Swaybar can be installed after the rest of the suspension is assembled.



Part # 11249590 - 1968-1972 A-Body Delrin Control Arm Bushings



Recommended Tools

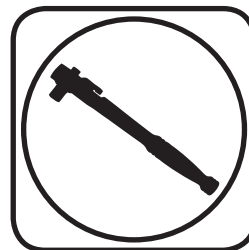

1968-1972 A-Body Delrin Control Arm Bushings Installation Instructions

Table of contents

Page 5..... Included components and Hardware List

Page 6..... Bushing Installation

IF YOUR CAR IS HAS AN OVAL BUSHING IN THE LOWER CONTROL ARM, IT WILL BE NECESSARY TO PURCHASE CONTROL ARMS THAT UTILIZE 2 ROUND BUSHINGS.



Major ComponentsIn the box

Part #	Description	QTY
70012382	Upper Control Arm Bushing Outer Shell - Upper	4
70012385	Lower Control Arm Bushing Outer Shell - Small Lower	2
70012386	Lower Control Arm Bushing Outer Shell - Large Lower	2
70012419	Delrin Upper Control Arm Bushing	4
70012423	Delrin Lower Control Arm Bushing - Small Lower	2
70012424	Delrin Lower Control Arm Bushing - Large Lower	2
90002521	Upper Control Arm Bushing Inner Sleeve	4
90000516	Lower Control Arm Bushing Inner Sleeve	4

Hardware Bag - Control Arm Kit

Part #	Description	Usage	QTY
99501006	1/2" -13 x 3 1/2" Hex Bolt	Lower Control Arm to Frame	4
99502009	1/2" -13 Nylok Nut	Lower Control Arm to Frame	4
99373005	3/8" Split Lockwasher	Upper Control Arm Shaft Bolts	4

Getting Started.....

The Front Control Arms will need to be removed from the car. Refer to the Factory Service Manual for disassembly procedure.

This A-Body Bushing Kit contains: 4 Upper Control Arm Bushing Assemblies and 4 Lower Control Arm Bushing Assemblies. The Upper Bushings are all the same; there are 2 different diameter Lower Bushings with the larger diameter Bushing being the Rear Bushing. Be sure to match the correct Bushings with the correct locations.

There are several different ways that the Bushings can be removed from the Control Arms. If you have an Air Chisel, a Wide Flat Bit works well. If you don't have access to an Air Chisel, they can be removed by first, Drilling out the rubber with a Hand Drill and Drill Bit. With the Rubber removed, distort the Bushing Shell with a Hammer and Chisel and Knock it out. No matter the process used, the main objective is to **NOT** distort the Control Arm.

WE RECOMMEND MARKING DRIVER AND PASSENGER CONTROL ARMS AND CROSS SHAFTS. ALSO, MARK THE ORIENTATION OF THE CROSS SHAFTS.

1. Measure the Outside Width of the Control Arms and write it down before starting Bushing Removal. You will use this Dimension to check the Control Arms after the new Delrin Bushings are installed.



Delrin Bushing Installation

The Cross Shaft must be put in place before installing the Bushing Shells in the Upper Control Arm.

Just like Bushing Removal, there are several ways the Delrin Bushing Assemblies can be installed. No matter the method used, the Control Arm needs to be **SUPPORTED** to keep from distorting the Control Arm. We recommend cutting spacers to go inside the Control Arms when using a Press to install the Bushings. We have used several different methods to install the Bushing Assemblies, we are going to cover the one that worked best for us. When installing the Bushings, the Outer Shell will be installed in the Arm by itself. Next, Press in the Delrin Bushing, followed by the Inner Sleeve. **WE DO NOT RECOMMEND INSTALLING THE BUSHINGS COMPLETELY ASSEMBLED.**

Note: The Delrin is self-lubricating, no lubricant is needed.

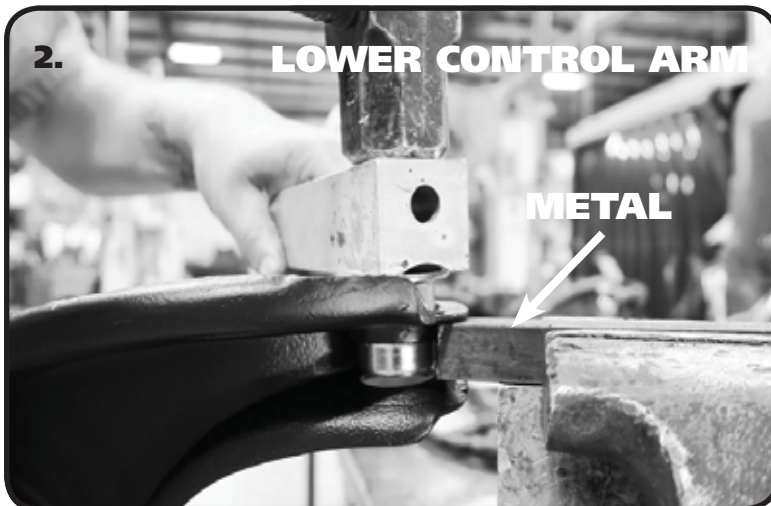

2. Disassemble the Bushing being installed. If installing Bushings in the Upper Control Arm, insert the Cross Shaft before installing any Bushings. Support the Back Side of the Flange the Bushing is being Installed in. Use a STIFF piece of Metal clamped in a Bench Vise for the Lower Control Arms (**Figure 2**). The Upper Control Arm can be supported by either the same piece of Metal or by the Bench Vise with the Jaws opened wide enough to let the Bushing Shell pass through (**Figure 3**).

3. Use another Piece of Metal or Strong Wood to Drive the Outer Shell into the Control Arm until the Shell stops against the Control Arm.



4. Press the Delrin Bushing into the Bushing Shell followed by the Inner Sleeve. DO NOT DRIVE IN WITH HAMMER.

5. Reinstall the Outer Washer using the OEM Bolt, but replace the Lockwasher with the supplied Lockwasher. Tighten Hardware to eliminate any gaps between the Bushings and Cross Shaft.

6. Reattach Control Arms to Car. Use the OEM Hardware to attach the Upper and the Supplied 1/2"-13 x 3 1/2" Hex Bolts and Nylok Nuts to Install the Lower Control Arms.



Part # 90000894 - A/F/X Tall Upper Balljoint



Recommended Tools



A/F/X Tall Upper Balljoint Installation Instructions

Table of contents
Page 8..... Included component & Balljoint Installation

DUE TO THE SHANK OF THE BALLJOINT BEING LONGER, THE BALLJOINT BOOT IS DESIGNED TO SEAL ON THE BALLJOINT SHANK. IT DOES NOT SEAL AGAINST THE SPINDLE.



Major ComponentsIn the box

Part #	Description	QTY
90000894	A/F/X Tall Upper Balljoint	2
90000898	Lower Balljoint	2

Balljoint Installation

The Tall Upper Balljoint is used in the StreetGrip Kit to help correct the Camber Gain. The Camber Gain on the OEM Suspension is incorrect and the Tall Balljoint repositions the Upper Control to help improve the Camber Gain.

The Upper Balljoint will need to be disconnected from the Spindle. Refer to the Factory Service Manual for Disassembly.



1. If your Balljoints are Bolted to the Control Arms, simply unbolt them. If your car has the Original Balljoints, they will be Riveted to the Control Arms. The Rivets can be removed by Grinding the Heads off and driving them out with a Hammer and Punch.

NOTE. WE RECOMMEND MARKING DRIVER AND PASSENGER CONTROL ARMS.



2. Insert the Balljoint into the Control Arm from the top side of the Control Arm with the Balljoint Pin Sticking down. Attach it to the Control Arm with the Hardware Supplied with the Balljoint. Torque the Hardware to 14 ftlbs. Engage the Balljoint Pin into the Spindle and install the Castle Nut Supplied. Torque the Castle Nut to 50 ftlbs and tighten to align Cotter Pin Hole. Install Cotter Pin through Hole and Bend Pins to prevent falling out.

3. Replace the lower balljoint by pressing the old one out and pressing the new one in. If you don't have a press, one can be rented from your local autoparts store.



Part # 11242350/11242351 - 1968-1972 A-Body Front CoilSpring



Recommended Tools

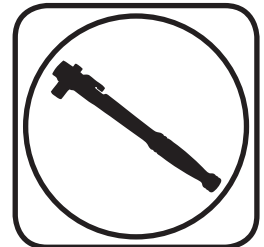

1968-1972 A-Body Front CoilSprings Installation Instructions

CoilSpring # 55450700 Small Block /**55520750** Big Block **Installation**

Front dual-rate spring will allow the vehicle to transition small road irregularities via a soft spring rate. When the vehicle compresses the spring far enough (through large bumps or cornering), it transitions to the firmer spring rate to control the bump or body roll. We have worked closely with Hyperco to develop custom dual rates to ensure the best ride possible.

The Front Control Arm Bushings and Upper Balljoint should be installed before installing spring. The Front Suspension should be assembled with the Lower Balljoint disconnected from the Spindle.

1. Compress the CoilSpring with an Internal Spring Compressor with the **CLOSE COILS TO THE BOTTOM**.
2. With the OEM Spring Removed, insert the CoilSpring into the Pocket. **SPECIAL ATTENTION NEEDS TO BE PLACED ON THE LOCATION OF THE ENDS OF THE SPRINGS TO MAKE SURE THEY ARE CLOKED CORRECTLY** . The end of the CoilSpring will nest into the receiver area of the Control Arm. If you line up the bottom, the top will be correct.
3. While holding the Spring in place, Slowly Jack the Lower Control Arm up until the Lower Balljoint can be Engaged into the Spindle. Install the Castle Nut and Torque to 65 ftlbs then tighten as needed to align cotter pin hole. Install Cotter Pin. Once the Balljoint is tight, remove the Spring Compressor.





Part # 11249120 - 1968-1972 A-Body Front SwayBar

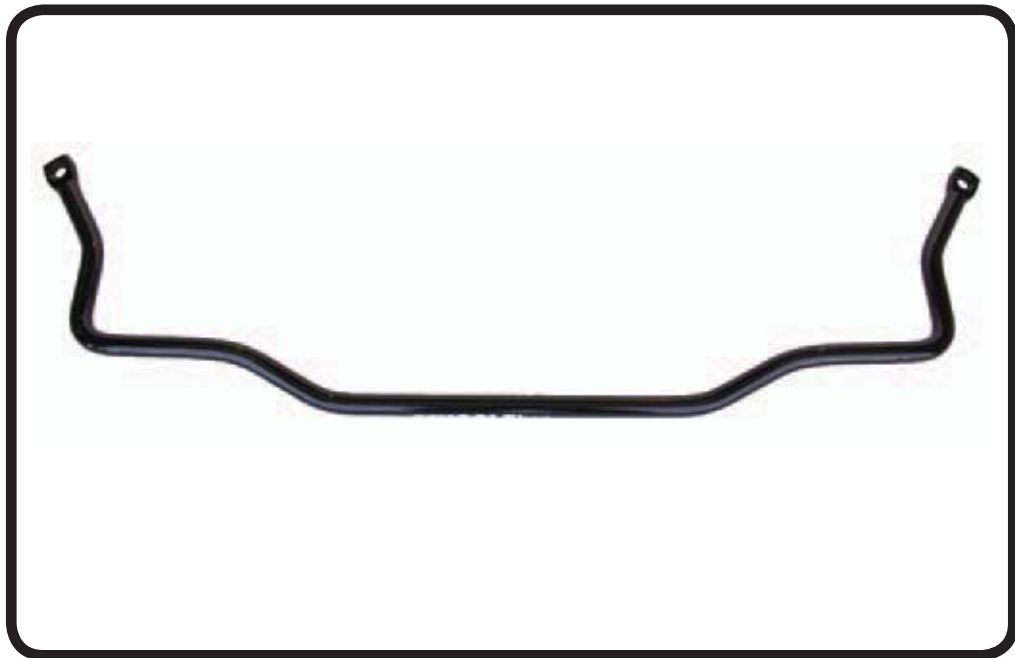

Recommended Tools

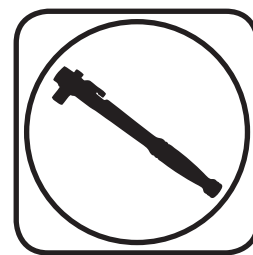
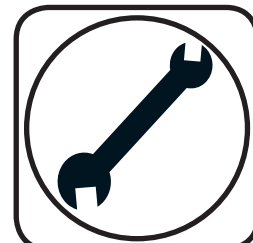

1968-1972 A-Body Front SwayBar Installation Instructions

Table of contents

Page 11..... Included components and Hardware List

Page 12..... SwayBar Installation

Page 13..... SwayBar Installation



Major ComponentsIn the box

Part #	Description	QTY
90002489	Front SwayBar	1
90002512	End Link Kit	1
70012394	Delrin Sway Bar Bushing Liner	2
90002513	Bushing Strap	2
90001099	SwayBar Bushing	2
90002509	Bushing Mount Adapter	2
90002263	Red Loctite	1

Hardware Bag - Front Sway Bar Kit

Part #	Description	Usage	QTY
99371032	3/8"-16 x 1 1/4" Flat Head	Adapter to Frame	2
99311025	5/16"-18 x 1 1/4" Flat Head	Adapter to Frame	2
99371004	3/8"-16 x 1 1/4" Hex Bolt	Bushing Strap to Frame	2
99311002	5/16"-18 x 1 1/4" Hex Bolt	Bushing Strap to Frame	2
99372002	3/8"-16 Nylok Nut	Bushing Strap to Adapter	2
99373003	3/8" SAE Flatwasher	Bushing Strap to Adapter & Frame	4
99313003	5/16" SAE Flatwasher	Bushing Strap to Frame	2
99373005	3/8" Split Lockwasher	Bushing Strap to Frame	2
99313002	5/16" Split Lockwasher	Bushing Strap to Frame	2

Getting Started.....

Install all Front StreetGrip Components before installing the SwayBar.

Remove the OEM Swaybar to prepare for the StreetGrip SwayBar installation.

Note: The Threaded Holes in the Frame can be either 5/16"-18 or 3/8"-16. Hardware is supplied for both.

This SwayBar kit utilizes a Delrin Liner in the SwayBar Bushing. The Delrin Liner allows the Swaybar to move freely and quietly in the Bushing. The Delrin is self-lubricating, no lubrication is required.



SwayBar Installation



1. Attach the Adapter Plate to Frame positioned with the 3/8"-16 Stud to the Front of the Car and the Rear Hole aligned with the Rear OEM Hole. The Adapter Plate is attached to the Frame using a Flat Head Bolt and Red Loctite. The OEM Threaded holes can be either, 5/16"-18 or 3/8" -16, hardware is supplied for each. Apply Red Loctite to the proper Bolt and insert it through the Adapter. Thread the Bolt into the Front OEM Hole and tighten.



2. The Delrin Liner is split on one side to ease installation. We found it easier to install by opening up the Liner enough to slide it onto the end of the SwayBar, then sliding it into position. It will open up and slide over the curves in the Bar. Install a Liner on each side of the SwayBar in the approximate location they will need to be when installing the SwayBar on the Car.

Note: The Delrin is self-lubricating, no lubricant is needed.



3. Open up the Poly SwayBar Bushings and install them over the Delrin Sleeves.



SwayBar Installation



4. Install Bushing Straps Over the Poly Sway-Bar Bushings.



5. Slide the SwayBar into position on the Car. The SwayBar Arms will be above the Tie Rods. Slide the Front Hole of the SwayBar Bushing onto the 3/8" -16 Stud. Hold it in place with a 3/8" SAE Flatwasher and 3/8" -16 Nylok Nut. Install the Correct Lockwasher and Flatwasher on the Correct Hex Bolt. Do **NOT** Complete tighten the Hardware. It will be left partially loose until the End Links are installed.

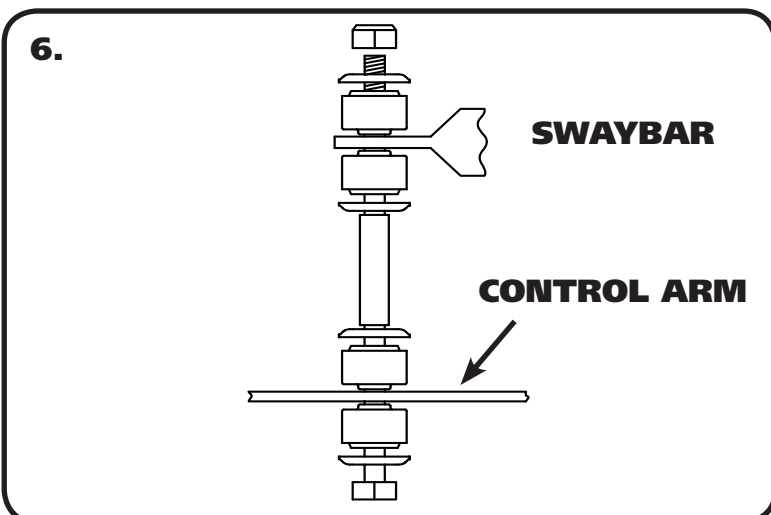

6. Install the End Links. Use Diagram "6" for proper installation. Tighten the Hex Nut enough to slightly compress the Bushings.

7. Tighten the Sway Bar Mounting Hardware.



Part # 11244799 - 1968-1972 A-Body Rear CoilSpring



Recommended Tools

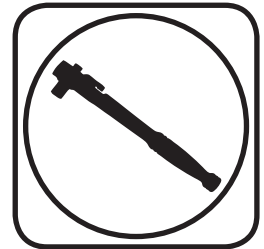

1968-1972 A-Body Rear Dual Rate CoilSprings

Installation Instructions

CoilSpring # 57128265 Installation

Rear dual-rate spring will allow the vehicle to transition small road irregularities via a soft spring rate. When the vehicle compresses the spring far enough (through large bumps or cornering), it transitions to the firmer spring rate to control the bump or body roll. We have worked closely with Hyperco to develop custom dual rates to ensure the best ride possible.

The Rear Shocks should be installed at the same time as the Rear CoilSprings.

1. Refer to the Factory Service Manual for CoilSpring Removal.
2. With the OEM Spring Removed and the Top of the StreetGrip Rear Shocks Bolted to the Frame, **Position the Spring in the Rear CoilSpring Pocket with the Large Diameter up in the Pocket.**
3. While holding the Spring in place, Slowly Jack the Differential up until the bottom Shock Mounting can be attached. Refer to Shock Instructions for proper Shock Assembly.





Front & Rear HQ Series Shocks



Recommended Tools

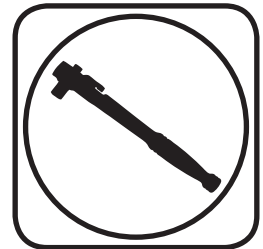

Front & Rear HQ Series Installation Instructions

Table of contents

Page	16.....	Rear Shock Installation
Page	17.....	Front Shock Installation
Page	18.....	Front Shock Installation & Adjustment





Rear - Part # 22189853 - 7.55" HQ Series Shocks

Major ComponentsIn the box

Part #	Description	QTY
22989999	7.55" Stroke Shock	2
70011139	5/8" ID Shock Bushing (Installed in Shock)	2
90002068	Wide Trunnion (Installed in Shock)	2
70011138	3/4" ID Shock Bushing (Installed in Shock)	2
90002103	5/8" ID Shock Sleeve (Installed in Shock)	2
90001619	Cantilever Pin	2
90000471	Cantilever Pin Spacer	2

Shock Installation

The Rear Shocks will be installed in conjunction with the Rear CoilSprings.

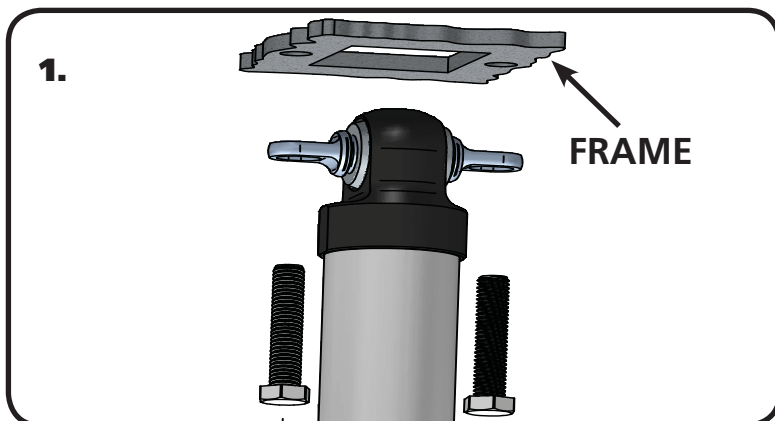

1. With the OEM Shock removed, install the Ridetech shock. Attach the Top of the Shock in the OEM Location using the OEM Hardware. It may be necessary to rotate the Trunnion to get it in the correct position. This can be done by sticking a screwdriver in one of the slots and spinning the trunnion in the shock bushing.

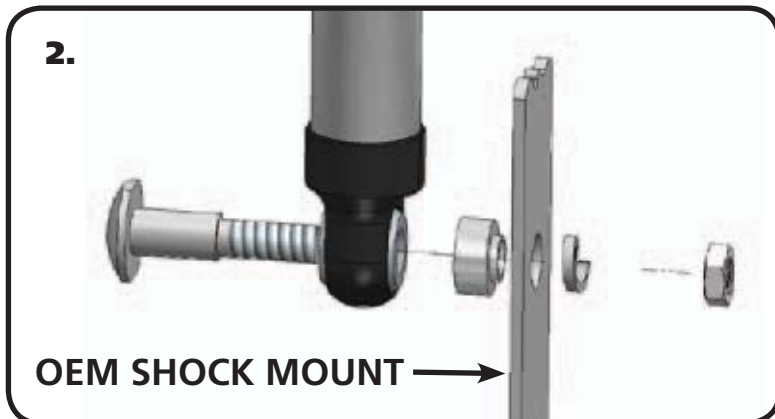

2. The Lower Shock is Bolted to the Lower OEM Mount using the supplied Cantilever Pin. Insert the Cantilever Pin into the Shock Bushing. Next, Slide the Aluminum Spacer onto the Threads of the Cantilever Pin. With the CoilSprings in place, Jack the Rear Differential up until the Shocks can be Bolted in place. Insert the Assembly into the OEM Shock Hole. Install the supplied Lockwasher and Hex Nut onto the Threads and tighten.



Front- Part #22149846 - 4.75" Stroke HQ Series Shocks

Major ComponentsIn the box

Part #	Description	QTY
22849599	4.75" Stroke Shock	2
70011139	5/8" ID Shock Bushing (Installed in Shock)	2
90002069	Standard Trunnion (Installed in Shock)	2
70011141	Bushing Support Washer	4
70011140	Stem Bushing	4
99372006	3/8"-24 Thin Jam Nut	4

Due to manufacturing tolerances it may be necessary to clearance the Control Arm to get the Shock through the Control Arm opening.

Shock Installation

Before installing the Shocks, the Control Arm Bushings, Upper Balljoint, and Coil-Springs should be installed.

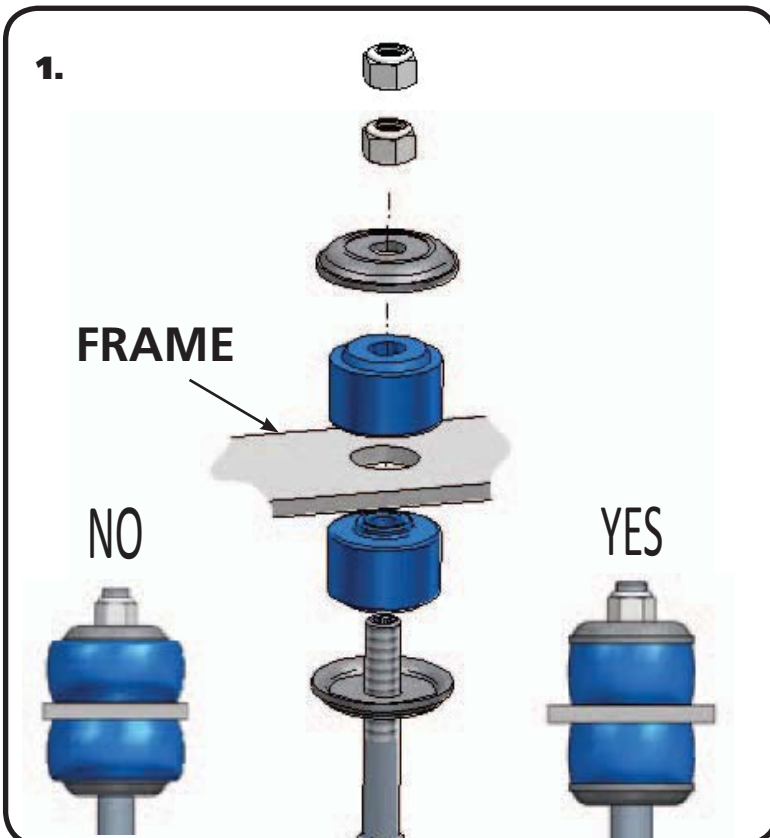

1. With the OEM shock removed, install the Ridetech shock. Install a Bushing Support Washer on to the shock shaft followed by a Shock Stem Bushing. Insert the assembly through the factory shock hole in the frame. With the shock stud sticking through the frame, install a Shock Stem Bushing on to the shock stud followed with a Bushing Support Washer. Install a 3/8"-24 Thin Jam nut onto the threads and tighten to 35 inlbs. The Bushing should be tight, but not to the point that the bushing is bulging past the Support Washer. Install the 2nd 3/8-24 Thin Jam nut and tighten it against the first nut. Reinstall Adjuster Knob.

NOTE: It may be necessary to remove the OEM Speed Nuts from the Control Arm to allow room for the Shock to slide through the opening in the Control Arm. The Speed Nuts can be reinstalled after the Shock is in position.



Shock Installation and Adjustment

2.

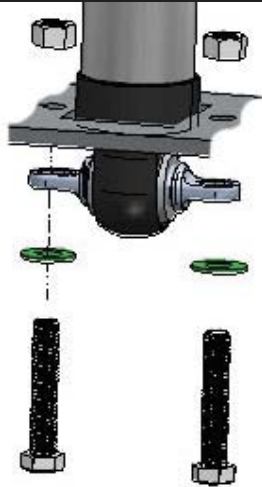

2. Attach the Trunnion to the OEM Control arm using the OEM hardware. It may be necessary to rotate the Trunnion to get it in the correct position. This can be done by sticking a screwdriver in one of the slots and spinning the trunnion in the shock bushing.

Shock adjustment 101- Single Adjustable

Rebound Adjustment:

How to adjust your new shocks

The rebound adjustment knob is located on the top of the shock absorber protruding from the eyelet or stud top. You must first begin at the ZERO setting, then set the shock to a street setting of 12 or handling setting of 8.



-Begin with the shocks adjusted to the ZERO rebound position (full stiff). Do this by rotating the rebound adjuster knob clockwise until it stops.

-Now turn the rebound adjuster knob counter clockwise 12 clicks. This sets the shock at 12 for a street setting. If you are after a handling setting only go 8 clicks.

Take the vehicle for a test drive.



-if you are satisfied with the ride quality, do not do anything, you are set!

-if the vehicle is too soft increase the damping effect by rotating the rebound knob clockwise 3 additional clicks.

-if the vehicle is too stiff rotate the rebound adjustment knob counter clock wise 2 clicks and you are set!

Take the vehicle for another test drive and repeat the above steps until the ride quality is satisfactory.

Note:

One end of the vehicle will likely reach the desired setting before the other end. If this happens stop adjusting the satisfied end and keep adjusting the unsatisfied end until the overall ride quality is satisfactory.



Part # 11229122 - 1964-1972 A-Body Rear SwayBar



Recommended Tools



**1964-1972 A-Body Rear SwayBar
Installation Instructions**

Table of contents
Page 20..... Included components and Hardware List
Page 21..... SwayBar Installation



Major Components & HardwareIn the box

Part #	Description	QTY
90002491	Rear SwayBar	1
90002501	Control Arm Spacer	4

Hardware Bag - Rear Sway Bar Kit

Part #	Description	Usage	QTY
99431003	7/16"-14 x 3" Hex Bolt	SwayBar to Control Arm	4
99432001	7/16"-14 Nylok Nut	SwayBar to Control Arm	4
99433002	7/16" SAE Flatwasher	SwayBar to Control Arm	8

Getting Started.....

If your Car is Equipped with an OEM SwayBar or has provisions for a SwayBar, skip to Step #3

If your Car wasn't equipped with a SwayBar, you will need to Drill Holes in the Lower Control Arms to attach the supplied SwayBar.

Your Car may have 1 Hole, it will be used for the Front Bolt Hole.

If your Car has Aftermarket Arms that have a Provision for a SwayBar, this SwayBar will fit them.

SwayBar Installation

3.

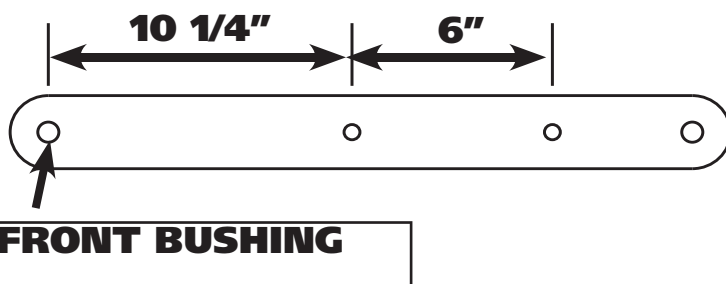

1. Some Cars have a Small Hole at the Front Bolt Location, if yours has it, Drill it out with a 7/16" Drill Bit and then Mark a Hole 6" towards the rear of the Car and Drill. If your Car has no Holes, Measure back 10 1/4" from the center of the Front Bushing and make a mark centered top to bottom. Next measure back 6" from your first mark and Mark the Second Hole centered Top to Bottom. Drill the Locations with a 7/16" Drill Bit going through both Sides of the Arm. Repeat for both Arms.



SwayBar Installation



2. Insert the Supplied Spacer into the inside of the Control Arm at the Hole Locations. These Spacers will get Clamped in place by the Mounting Hardware after the SwayBar is installed. These can be welded in place if desired.



3. Slide the bar in Place with the **LOW** part of the bar down. Install a 7/16" washer on one of the 7/16"-14 x 3" Bolts and install one in each Front Hole to help hold it in place. Swing the SwayBar into position and insert the Rear Bolt/Washer. Tighten Hardware.