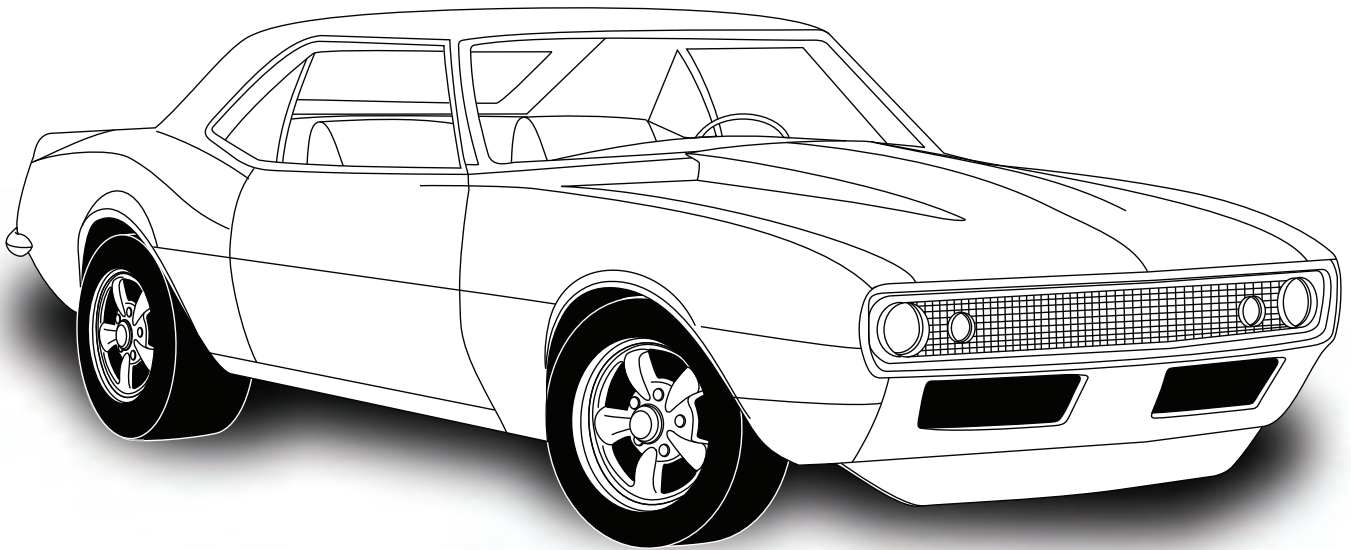




**1967-68 Chevrolet Camaro/  
Pontiac Firebird**  
*without* Factory Air  
**Gen 5 Evaporator Kit**  
**(561244)**



18865 Goll St. San Antonio, TX 78266  
Phone: 800-862-6658  
Sales: [sales@vintageair.com](mailto:sales@vintageair.com)  
Tech Support: [tech@vintageair.com](mailto:tech@vintageair.com)  
[www.vintageair.com](http://www.vintageair.com)



www.vintageair.com

# Table of Contents

Cover..... 1

Table of Contents..... 2

Packing List/Parts Disclaimer..... 3

Information Page..... 4

Wiring Notice..... 5

Engine Compartment Disassembly, Condenser Assembly and Installation..... 6

Compressor and Brackets, Passenger Compartment Disassembly..... 7-9

Firewall Modification, Defrost Duct & Fresh Air Cover Installation..... 10

Dash Frame Modification, Trim Plate Modification..... 11

Driver & Passenger Side Dash Modifications (1967 Models Only)..... 12

Driver- & Passenger-Side Louver Installation (1967 Models Only), Driver- & Passenger-Side OEM Louver Modification..... 13

OEM Louver Assembly..... 14

Kick Panel Modification..... 15

Firewall Cover Installation, Lubricating O-rings..... 16

Evaporator Module Preparation..... 17-18

Fresh Air Cap & Kick Panel Cover Preparation, Heater and A/C Hose Installation..... 19-20

Wiring Installation, Kick Panel Installation..... 21

Evaporator Installation, Drain Hose Installation..... 22-23

Firewall Cover Installation..... 24

Passenger Compartment Wiring..... 25

ECU, Control Panel & Duct Hose Routing..... 26

Center Louver Installation..... 27

Driver- & Passenger-Side Louver Installation, Control Panel Installation, Fresh Air Cap Installation... 28

Inner Fender Cover, A/C Hose Installation..... 29

Heater Control Valve Installation..... 30

Quality Crimp Guideline..... 31

Engine Compartment Wiring..... 32-33

Final Steps: Installation Check..... 34

ECU Mounting, Glove Box Installation..... 35

Final Steps: Completing the Install..... 36

Gen 5 Wiring Diagram..... 37

Gen 5 Wiring Connection Instruction..... 38

Operation of Controls..... 39

Troubleshooting Guide, Advanced Diagnostics and Troubleshooting Guide..... 40-41

Packing List..... 42



A detailed tech video outlining the installation process of a Gen IV unit is available on Vintage Air's YouTube channel at <http://bit.ly/2GWAXWY>.

Installation processes of Gen IV and Gen 5 units are similar. Viewing the tech video along with the written instructions will provide the installer the most detailed installation procedure.



www.vintageair.com

## Packing List: Evaporator Kit (561244)

No.	Qty.	Part No.	Description
1.	1	765200	Gen 5 Super Magnum Module
2.	1	781244	Accessory Kit

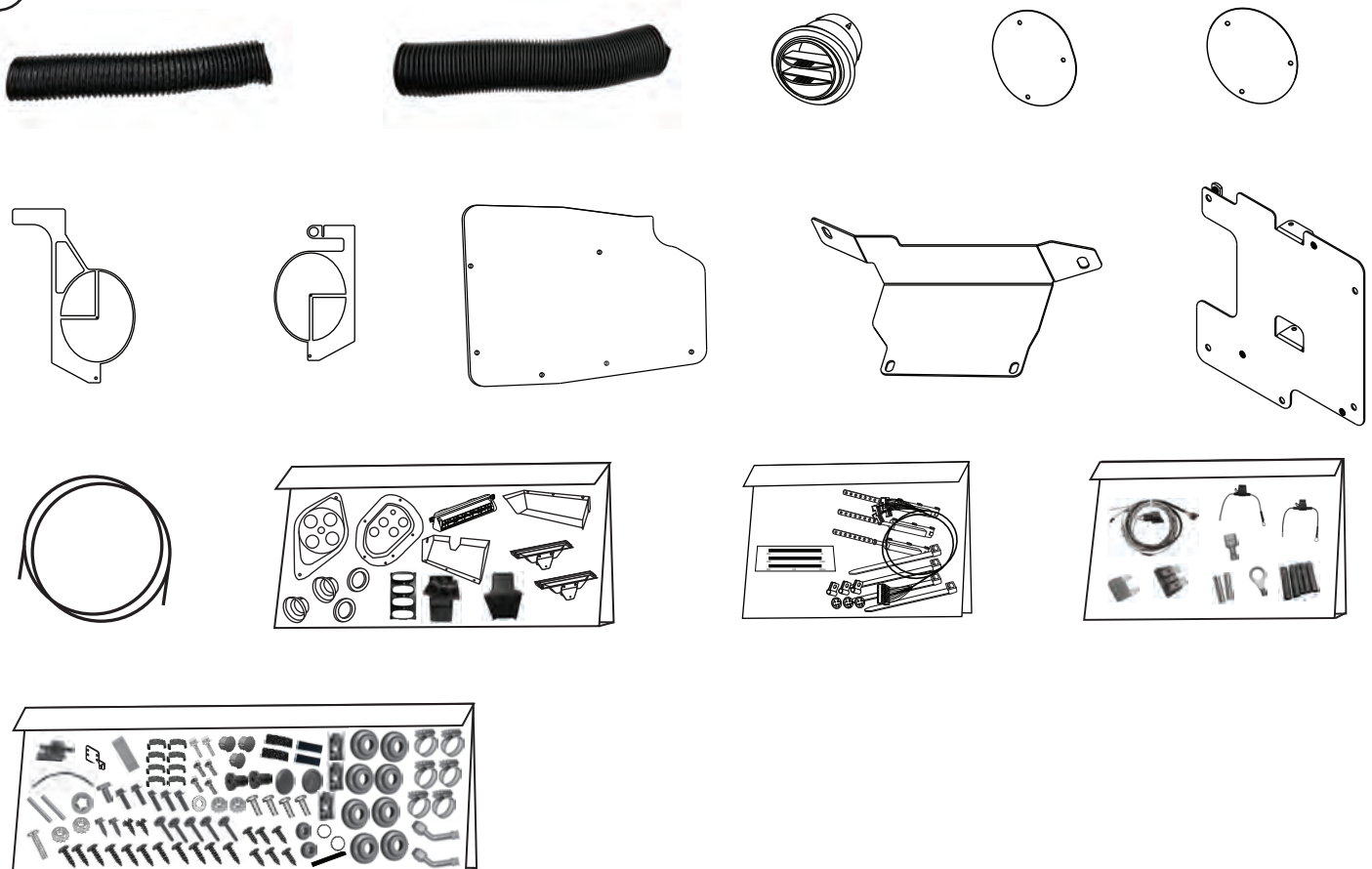
**\*\* Before beginning installation, open all packages and check contents of shipment. Please report any shortages directly to Vintage Air within 15 days. After 15 days, Vintage Air will not be responsible for missing or damaged items.**

1



Gen 5 Super Magnum  
Module  
765200

2



Accessory Kit  
781244

**NOTE: Images may not depict actual parts and quantities. Refer to packing list for actual parts and quantities.**



www.vintageair.com

## Important Notice—Please Read

*For Maximum System Performance, Vintage Air Recommends the Following:*

**NOTE:** Vintage Air systems are designed to operate with R134a refrigerant only. Use of any other refrigerant could damage your A/C system and/or vehicle, and possibly cause a fire, in addition to potentially voiding the warranties of the A/C system and its components.

### Refrigerant Capacities:

**Vintage Air System:** 1.8 lbs. (28.8 oz.) or 816 grams of **R134a**, charged by weight with a quality charging station or scale. **NOTE: Use of the proper type and amount of refrigerant is critical to system operation and performance.**

**Other Systems:** Consult manufacturer's guidelines.

### Lubricant Capacities:

**New Vintage Air-Supplied Sanden Compressor:** No additional oil needed (Compressor is shipped with proper oil charge).

**All Other Compressors:** Consult manufacturer (Some compressors are shipped dry and will need oil added).

### Safety Switches

Your Vintage Air system is equipped with a binary pressure safety switch. A binary switch disengages the compressor clutch in cases of extreme low pressure conditions (refrigerant loss) or excessively high head pressure (406 PSI) to prevent compressor damage or hose rupture. A trinary switch combines Hi/Lo pressure protection with an electric fan operation signal at 254 PSI, and should be substituted for use with electric fans. Compressor safety switches are extremely important since an A/C system relies on refrigerant to circulate lubricant.

### Service Info:

**Protect Your Investment:** Prior to assembly, it is critical that the compressor, evaporator, A/C hoses and fittings, hardlines, condenser and receiver/drier remain capped. Removing caps prior to assembly will allow moisture, insects and debris into the components, possibly leading to reduced performance and/or premature failure of your A/C system. This is especially important with the receiver/drier.

Additionally, when caps are removed for assembly, **BE CAREFUL!** Some components are shipped under pressure with dry nitrogen.

**Evacuate the System for 35-45 Minutes:** Ensure that system components (Drier, compressor, evaporator and condenser) are at a temperature of at least 85°F. On a cool day, the components can be heated with a heat gun **or** by running the engine with the heater on before evacuating. Leak check and charge to specifications.

### Bolts Passing Through Cowl and/or Firewall:

To ensure a watertight seal between the passenger compartment and the vehicle exterior, for all bolts passing through the cowl and/or firewall, Vintage Air recommends coating the threads with silicone prior to installation.

### Heater Hose (not included with this kit):

Heater hose may be purchased from Vintage Air (Part#31800-VUD) or your local parts retailer. Routing and required length will vary based on installer preference.



www.vintageair.com

## Important Wiring Notice—Please Read

*Some vehicles may have had some or all of their radio interference capacitors removed. There should be a capacitor found at each of the following locations:*

- 1. On the positive terminal of the ignition coil.**
- 2. If there is a generator, on the armature terminal of the generator.**
- 3. If there is a generator, on the battery terminal of the voltage regulator.**

Most alternators have a capacitor installed internally to eliminate what is called “whining” as the engine is revved. If whining is heard in the radio, or just to be extra cautious, a radio interference capacitor can be added to the battery terminal of the alternator.

It is also important that the battery lead is in good shape and that the ground leads are not compromised. There should be a heavy ground from the battery to the engine block, and additional grounds to the body and chassis.

If these precautions are not observed, it is possible for voltage spikes to be present on the battery leads. These spikes come from ignition systems and charging systems, and from switching some of the vehicle’s other systems on and off. Modern computer-operated equipment can be sensitive to voltage spikes on the power leads, which can cause unexpected resets, strange behavior and/or permanent damage.

Vintage Air strives to harden our products against these types of electrical noise, but there is a point where a vehicle’s electrical system can be degraded so much that nothing can help.

Radio interference capacitors should be available at most auto and truck parts suppliers. They typically are cylindrical in shape, a little over an inch long and a little over a half-inch in diameter, and they have a single lead coming from one end of the cylinder with a terminal on the end of the wire, as well as a mounting clip which is screwed into a good ground on the vehicle. The specific value of the capacitance is not too significant in comparison to ignition capacitors that are matched with the coil to reduce pitting of the points.

- Care must be taken, when installing the compressor lead, not to short it to ground. The compressor lead must not be connected to a condenser fan or to any other auxiliary device. Shorting to ground or connecting to a condenser fan or any other auxiliary device may damage wiring or the compressor relay, and/or cause a malfunction.
- When installing ground leads on Gen 5 systems, the blower control ground and ECU ground must be connected directly to the negative battery post.
- For proper system operation, the heater control valve must be connected to the ECU.



www.vintageair.com

## Engine Compartment Disassembly

**NOTE:** Before starting the installation, check the function of the vehicle (horn, lights, etc.) for proper operation, and study the instructions, illustrations, photos & diagrams.

Perform the Following:

1. Disconnect the battery.
2. Remove the battery and battery tray (retain) (See Figure 1, below).
3. Drain the radiator.
4. Remove the OEM heater hoses (discard) (See Figure 1, below).
5. Remove the OEM blower motor assembly (See Figure 1, below). **NOTE:** To remove the blower assembly (under hood) and the air distribution system (under dash), the factory manual recommends the following: Remove the right lower rocker molding. Remove the fender attaching bolts. Remove the skirt-to-fender and skirt-to-reinforcement screws. Pull out on the lower portion of the fender, moving the skirt away from the fender flange and firewall. Block the skirt with a 2" x 4" block of wood. To avoid damage to the paint and sheet metal, and for ease of removal and replacement of components, Vintage Air recommends that the right fender be removed, and the inner panel lowered. Removing the right front tire will provide easier access to the inner fender bolts.
6. Remove the OEM heater wiring/vacuum harness molded grommet (discard) (See Figure 1, below).
7. Install a 1 5/8" plug into the firewall to cover the OEM firewall hole (See Photo 1, below). **NOTE: A 1 1/2" plug is also provided. Use the plug that best fits the vehicle.**

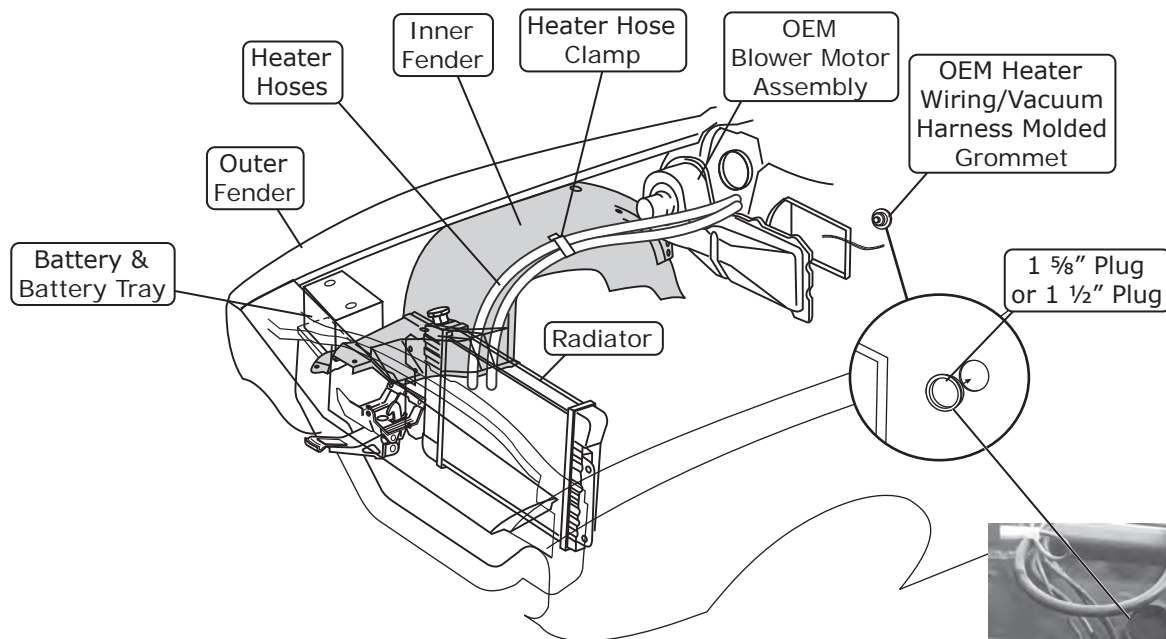


Figure 1

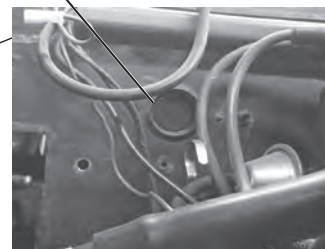


Photo 1

## Condenser Assembly and Installation

1. Refer to separate instructions included with the condenser kit to install the condenser.
2. Binary switch installation (Refer to condenser instructions).



www.vintageair.com

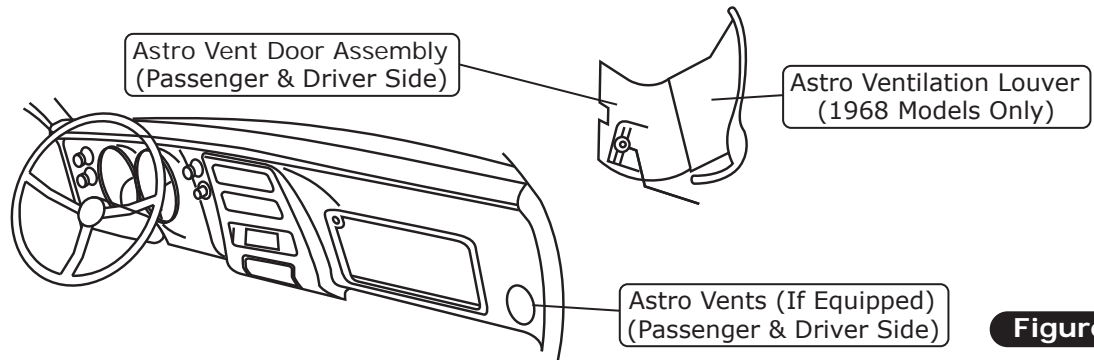
## Compressor and Brackets

1. Refer to separate instructions included with the bracket kit to install the compressor bracket.

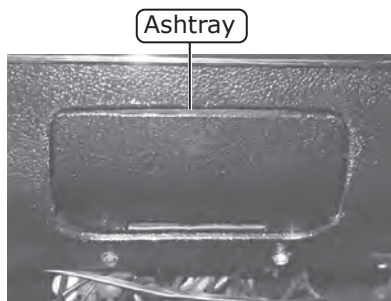
### Passenger Compartment Disassembly

**NOTE:** For ease of installation, Vintage Air recommends removing the front seats.

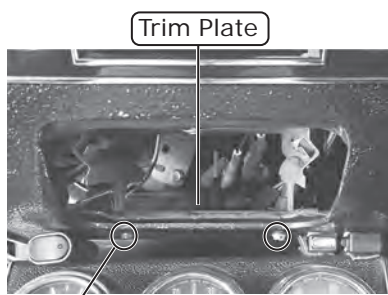
1. On 1968 models equipped with astro ventilation, remove the astro vents and door assemblies (retain the astro vents, but discard the door assemblies) (See Figure 1, below).
2. Remove the ashtray (retain) (See Photo 1, below).
3. Remove the trim plate and (2) screws (retain) (See Photo 2, below). **NOTE: The center console may have to be loosened to gain access to the trim plate screws. The bottom (2) screws also retain the ashtray slider assembly (See Photo 3, below).**
4. Remove the ashtray slider assembly by removing the screw (retain) (See Photo 3, below).
5. Remove the glove box door by removing (3) screws (retain) (See Photo 4, below).
6. Remove the glove box by removing (4) screws ((2) on top & (2) on the sides) (discard) (See Photo 5, below).



**Figure 1**

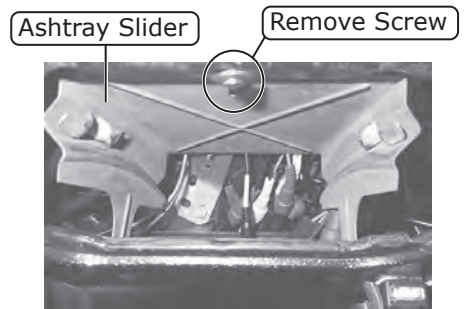


**Photo 1**



Remove (2) Screws

**Photo 2**

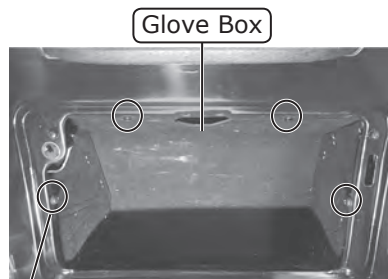


**Photo 3**



Glove Box Door

**Photo 4**



Remove (4) Screws

**Photo 5**



www.vintageair.com

## Passenger Compartment Disassembly (Cont.)

7. Remove the radio by removing the knobs and retaining nuts (retain) (See Figure 2, below).
8. Disconnect the wiring and antenna cable from the radio (retain).
9. Remove the OEM control panel assembly by removing (4) screws from the dash (retain) and disconnecting the light socket (retain) and cables (discard) (See Photo 6, below).
10. Loosen and lower the steering column by removing the (2) nuts from under the column (retain) (See Photo 7, below).

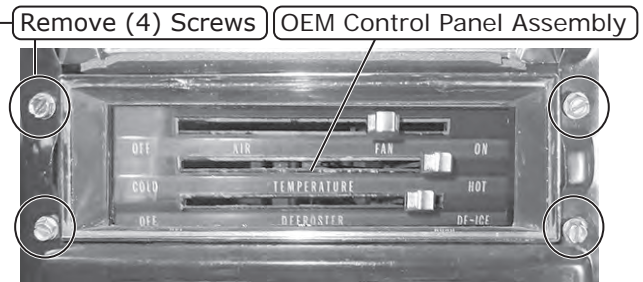


Photo 6

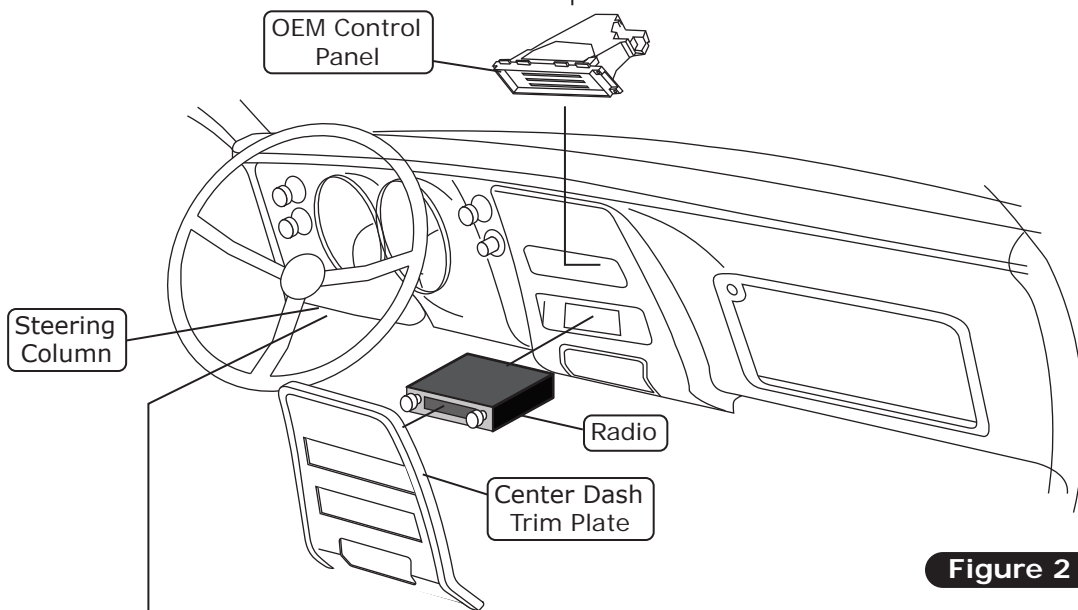


Figure 2

Remove (2) nuts under steering column

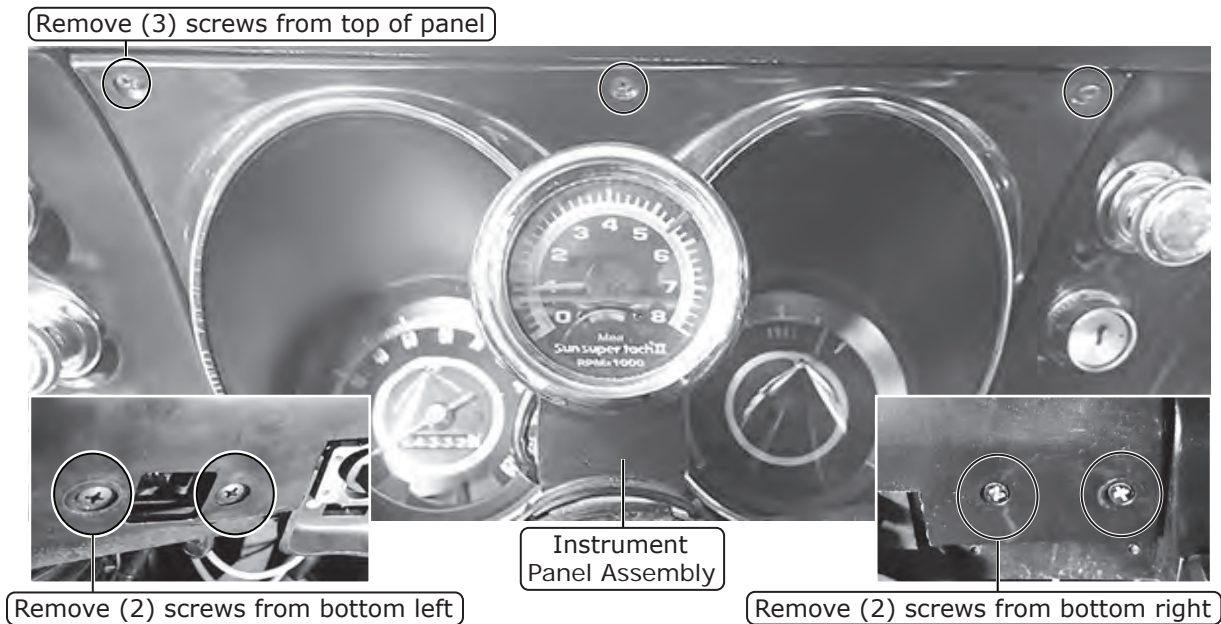


Under Steering Column View Photo 7

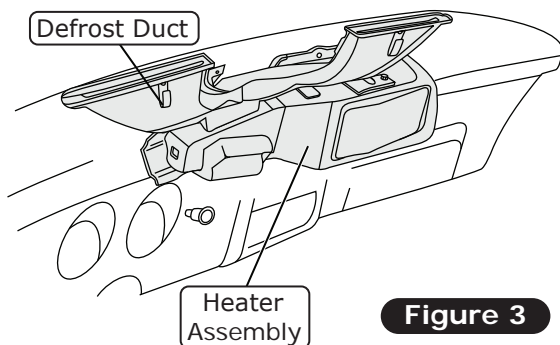


## Passenger Compartment Disassembly (Final)

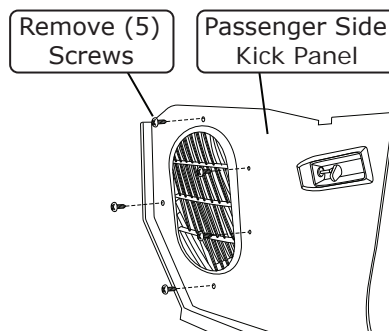
11. Remove (3) screws from the top of the instrument panel and (4) screws from the bottom of the instrument panel ((2) from the left side and (2) from the right side) (retain) (See Photo 8, below).
12. Disconnect the speedometer cable and wiring plug.
13. Remove the instrument panel (retain).
14. Remove the OEM defrost duct (discard) (See Figure 3, below).
15. Remove the OEM heater assembly (discard) (See Figure 3, below).
16. Remove the passenger side kick panel by removing (5) screws (discard screws) (See Figure 4, below).
17. On 1968 models, remove the driver- and passenger-side louvers by removing (2) mounting screws from each louver bezel (See Photo 9, below).



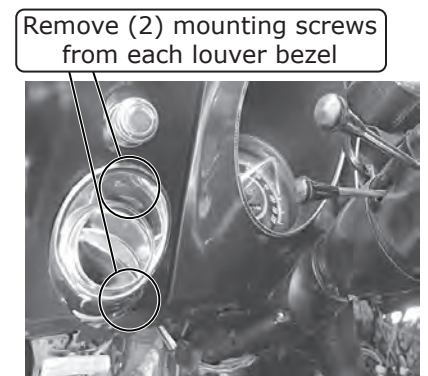
**Photo 8**



**Figure 3**



**Figure 4**



**Photo 9**

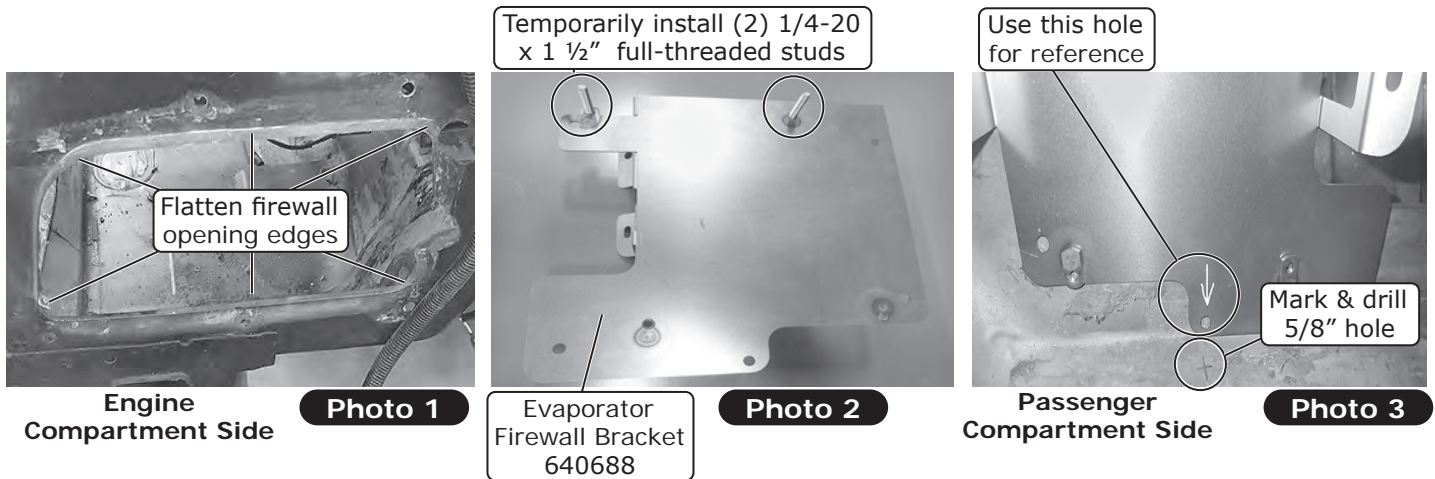


www.vintageair.com

## Firewall Modification

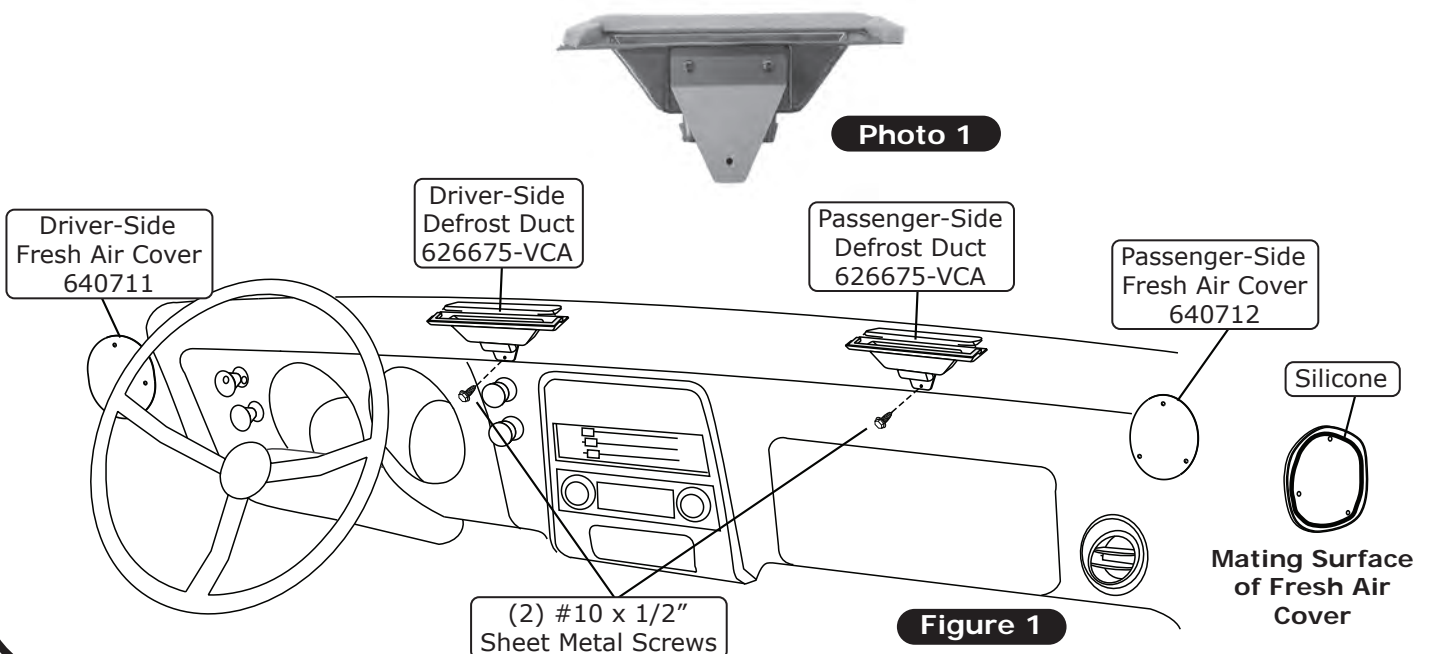
**NOTE: Firewall modification is required for firewall cover and drain hose installation.**

1. Flatten the edges of the firewall opening (See Photo 1, below).
2. Temporarily install (2) 1/4-20 x 1 1/2" studs into the evaporator firewall bracket as shown in Photo 2, below.  
**NOTE: This will align the bracket with the mounting holes in the firewall.**
3. From inside the passenger compartment, temporarily install the evaporator firewall bracket. Using the bottom hole on the evaporator firewall bracket as a reference, mark and drill a 5/8" hole for the drain hose as shown in Photo 3, below. **NOTE: To ensure a tight fit, do not enlarge the hole to more than 5/8".**
4. Remove the evaporator firewall bracket.



## Defrost Duct & Fresh Air Cover Installation

1. Locate the (2) defrost duct assemblies (See Photo 1, below)
2. Install the defrost ducts under the dash (See Figure 1, below). Align each defrost duct with the defrost opening in the dash, and hold it in place. Using the bracket as a template, drill a 7/64" hole for each duct as shown below. Secure each defrost duct using a #10 x 1/2" sheet metal screw (See Figure 1, below).
3. If the vehicle is equipped with astro ventilation, apply a 1/4" bead of silicone to the mating surface, and install the driver- and passenger-side fresh air covers, using the OEM hardware to secure (See Figure 1, below).

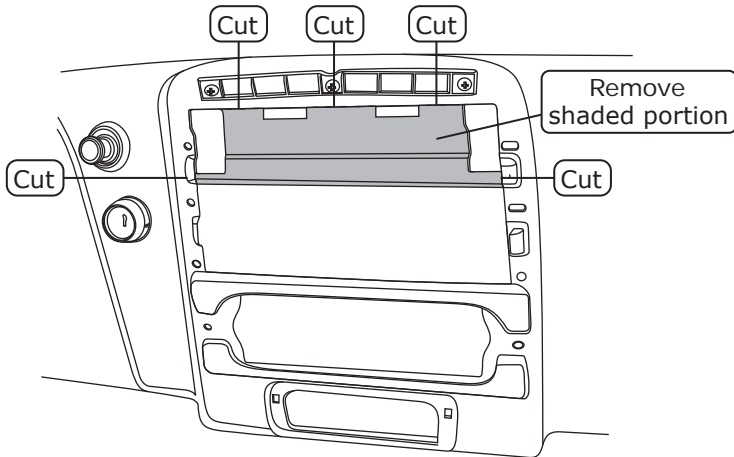




www.vintageair.com

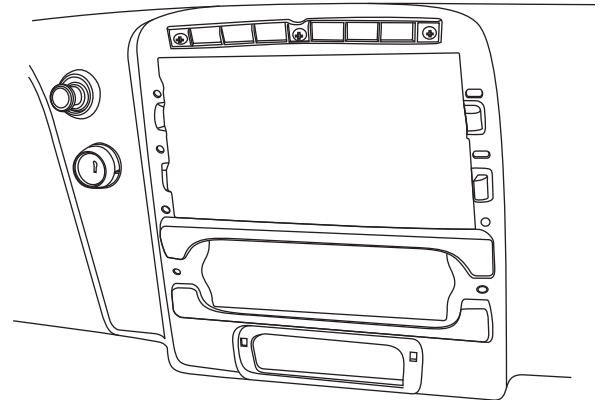
## Dash Frame Modification

1. Modify the dash as shown in Figure 1, below.



Before Modification

Figure 1



After Modification

## Trim Plate Modification

**NOTE:** For an upgraded chrome OEM-style center louver (Vintage Air Part # 493068), it will be necessary to purchase a factory A/C dash trim plate.

1. Locate the center louver template (See Photo 1, below).
2. Center the template onto the trim plate as shown in Photo 2, below.
3. Mark the center louver opening on the trim plate (See Photo 3, below).
4. Once the center louver opening is marked, remove the template and carefully cut out the opening in the trim plate. The finished modified trim plate is shown in Photo 4, below.

Center Louver Template 640702



OEM Trim Plate



Photo 1

Center template on trim plate



Photo 2

Mark louver opening on trim plate



Photo 3

Trim plate with cutout



Photo 4



www.vintageair.com

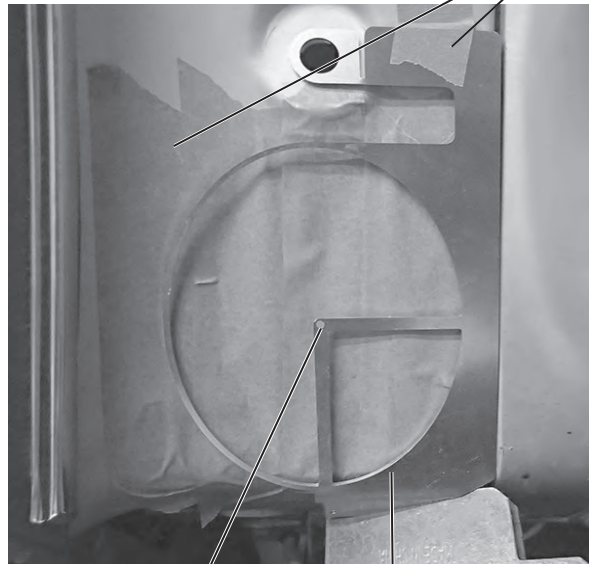
# Driver & Passenger Side Dash Modifications (1967 Models Only)

**NOTE:** To accommodate the driver and passenger side louvers, it will be necessary to modify the dash by cutting (2) holes using the templates provided with this kit. For standard 2 1/2" louvers (supplied with this kit), use the center hole on the appropriate template to drill a pilot hole before enlarging the hole as explained in the instructions below. For OEM-style louvers (NOT supplied with this kit but available for separate purchase (Part # 49306-VCL), scribe the dash around the outer part of the template holes as shown in Photos 1 & 2, below. To avoid scratching the paint, apply masking tape to the dash and templates.

1. Place the driver- and passenger-side louver templates onto the dash (See Photos 1 & 2, below). Use a clamp to hold the templates in place (See Photo 2, below).
2. Press on the templates to conform them to the shape of the dash. Once the templates are in place, use a center punch to mark the dash as shown in Photos 1 & 2, below. Once marked, remove the templates from the dash.
3. Using a 2 1/2" hole saw, cut holes in the dash for the driver- and passenger-side louvers. **NOTE: Before drilling, check for and secure any wiring behind the dash that may come into contact with the hole saw blade.**

Driver-Side Louver Template  
640701

Masking  
Tape



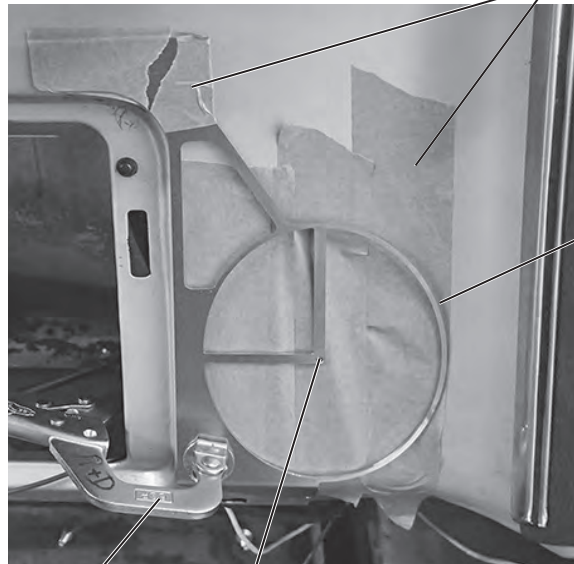
Use center punch to mark dash (For standard louvers)

Scribe outer part of template hole for OEM-style louvers

Photo 1

Passenger-Side Louver Template  
640700

Masking  
Tape



Scribe outer part of template hole for OEM-style louvers

Clamp

Use center punch to mark dash (For standard louvers)

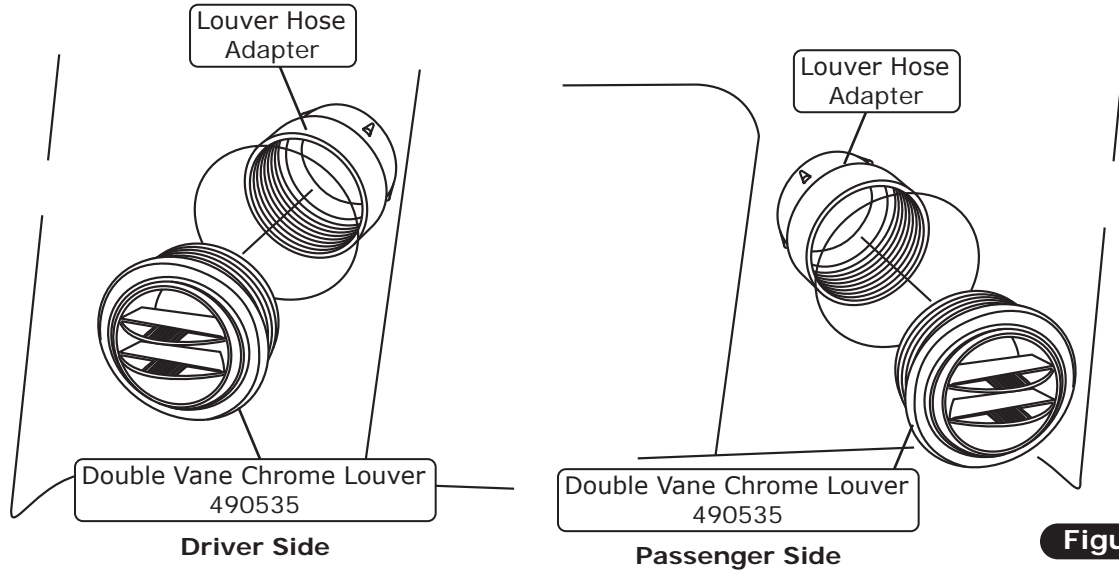
Photo 2



www.vintageair.com

## Driver- & Passenger-Side Louver Installation (1967 Models Only)

1. Separate the double vane chrome louver assemblies, and insert the louvers into the dash openings. From behind the dash, install the hose adapters onto the louvers as shown in Figure 1, below.



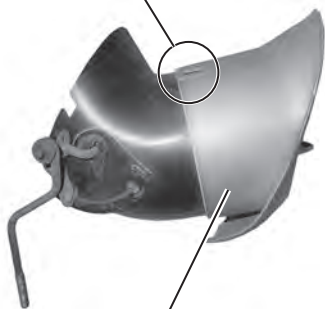
**Figure 1**

## Driver- & Passenger-Side OEM Louver Modification

**NOTE: To install the new 2 1/2" hose adapters, it will be necessary to modify the driver- and passenger-side OEM louvers.**

1. Disassemble the OEM louver by unclipping the (3) tabs on the louver housing, then pulling the assembly apart (See Photo 1, below).
2. Remove the ball louver from the louver housing (See Photo 2, below).
3. Measure and mark 1/4" from the edge of the louver housing (See Photos 3 & 4, below). **NOTE: Repeat the process (2) more times around the louver housing.**
4. Drill (3) 1/8" holes into the louver housing (See Photo 4, below).

Unclip (3) tabs on louver housing



Louver Housing

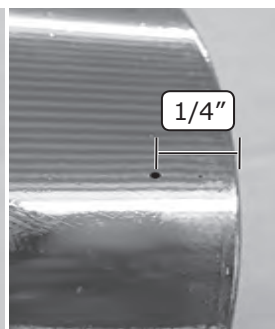
**Photo 1**

Remove ball louver from louver housing



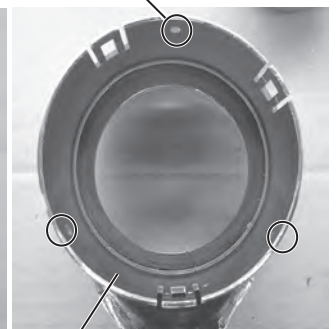
**Photo 2**

1/4"



**Photo 3**

Mark and drill (3) 1/8" holes



Louver Housing

**Photo 4**



www.vintageair.com

## OEM Louver Assembly

1. Adhere a length of the supplied felt strip to the beveled edge inside the inner louver hose adapter. **NOTE: Cut the felt strip to fit as needed (See Photo 1, below).**
2. Insert the OEM ball louver into the OEM louver housing (See Photo 2, below).
3. Install the inner louver hose adapter into the OEM louver housing (See Photo 3, below).
4. Install the outer louver hose adapter flush with the back of the louver housing as shown in Photo 4, below. **NOTE: Before continuing to the next step, ensure that the ball louver can be adjusted if it is too tight or too loose. If adjustment is required, it will need to be completed before the adapter is secured to the housing. If desired, for ease of assembly, (3) small pilot holes (approximately 5/64") can be drilled into the outer ring.**
5. Install (3) #6 x 3/8" pan head screws into the previously drilled holes on the louver housing (See Photo 5, below).

Inner Louver  
Hose Adapter  
49872-VCI

Install Felt Strip  
200101

Insert louver ball  
into housing

Install inner louver  
hose adapter into  
housing



Photo 1



Photo 2

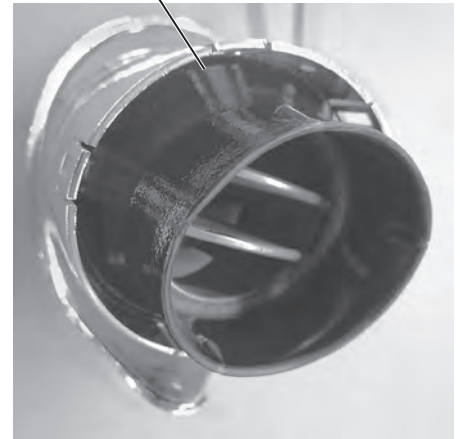


Photo 3

Install outer louver  
hose adapter to  
back of housing



Photo 4

Install (3) #6 x 3/8"  
pan head screws into  
previously drilled holes

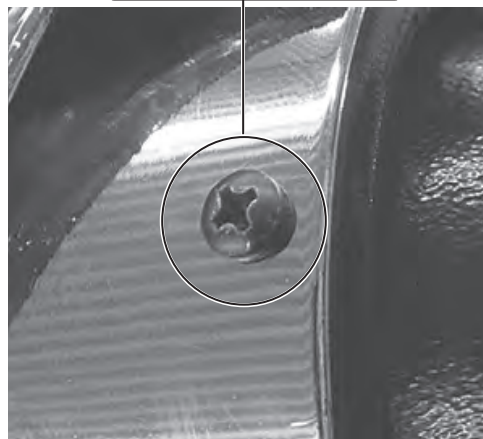


Photo 5



www.vintageair.com

## Kick Panel Modification

1. Remove the fresh air door assembly from the OEM kick panel by lifting up on the door toward the spring and sliding it out of the hinge housing (See Photo 1, below).
2. Disconnect and remove the fresh air door cable from the OEM lever housing (discard) (See Photo 2, below).
3. Trim the fresh air door housing flush with the back of the OEM kick panel, and discard the excess material (See Photo 3, below).
4. Remove the kick panel vent (See Photos 4 & 5, below).

Fresh Air Door Assembly

Lift door toward spring to remove

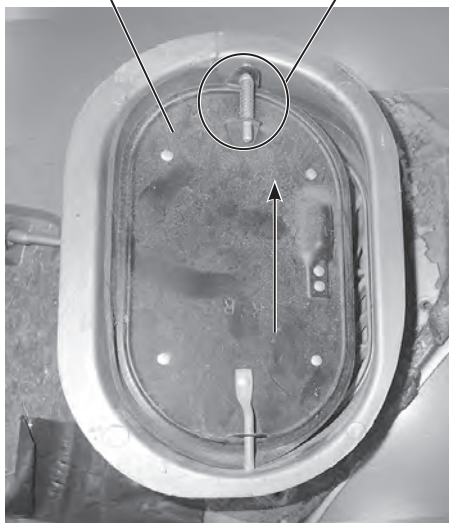


Photo 1

Disconnect fresh air door cable



Photo 2

Trim flush with kick panel housing

Fresh Air Door Housing

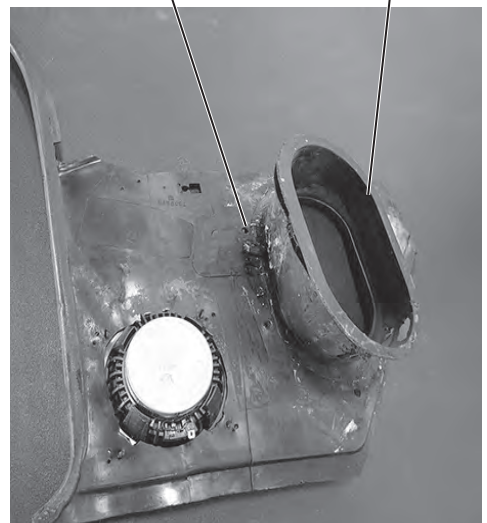
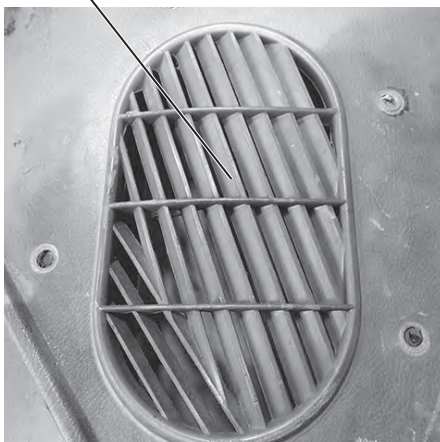


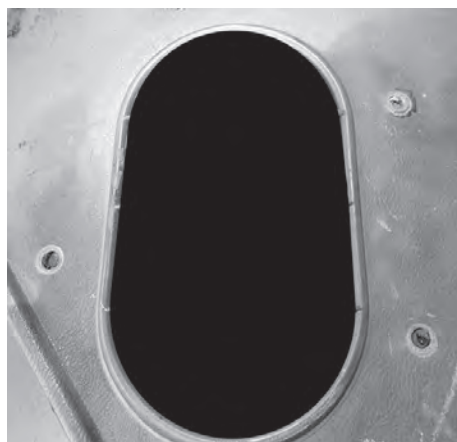
Photo 3

Remove kick panel vent



Before Modification

Photo 4



After Modification

Photo 5



www.vintageair.com

## Firewall Cover Insulation

**NOTE:** For proper system operation, Vintage Air recommends using heat blocking insulation in the area around the evaporator unit (firewall, kick panel, inner cowl, firewall covers). Due to tight clearance for the evaporator unit between the firewall and dash, Vintage Air recommends an insulation thickness of no more than 1/4".

1. To apply insulation to the firewall cover, temporarily install the firewall cover onto the firewall using (2) 1/4-20 x 3/4" bolts and (2) 1/4-20 nuts with star washers (See Photo 1, below).
2. From the passenger compartment, trace the firewall opening onto the firewall cover (See Photo 2, below).
3. Remove the firewall cover, and apply insulation to the traced area (See Photo 3, below).

Temporarily install firewall cover with (2) 1/4-20 x 3/4" bolts & (2) 1/4-20 nuts with star washers



Firewall Cover 640687

Photo 1

Trace firewall opening

Firewall Cover 640687



Passenger Compartment View

Photo 2

Apply insulation to traced area

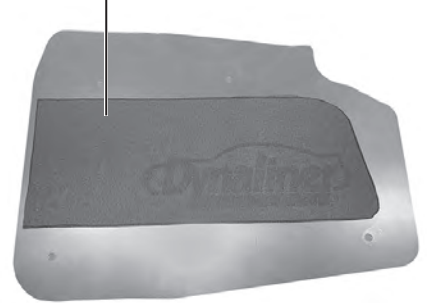
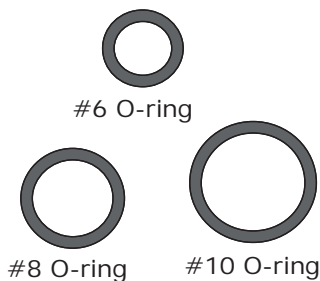


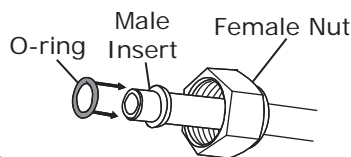
Photo 3

## Lubricating O-rings

**For a proper seal of fittings: Install supplied O-rings as shown and lubricate with supplied oil.**

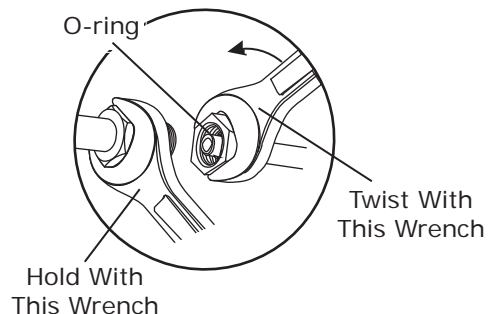
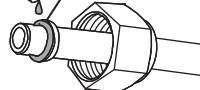


**NOTE: Standard torque specifications:**  
 #6: 11 to 13 ft-lb.  
 #8: 15 to 20 ft-lb.  
 #10: 21 to 27 ft-lb.



Supplied Oil for O-rings

O-ring Installs Over Male Insert to Swaged Lip







www.vintageair.com

## Evaporator Module Preparation

Perform the following on a workbench:

1. Install (3) 1/2" plastic plugs into the back of the evaporator module (See Photos 1, 2, 3 and 4, below).
2. Using a properly lubricated #10 O-ring (See Lubricating O-rings, Page 16), install the upper heater hardline onto the evaporator module (See Photo 5, below). **NOTE: Install the hardline facing down.**
3. Using a properly lubricated #10 O-ring (See Lubricating O-rings, Page 16, install the lower heater hardline onto the evaporator module (See Photo 6, below). **NOTE: Install the hardline facing down.**
4. Install the evaporator firewall bracket using (4) #10 x 5/8" screws (See Photos 7, 8 and 9, below).

Install 1/2" plastic plug into back of evaporator unit



Photo 1

1/2" plastic plug



Photo 2

Install (2) 1/2" plastic plugs

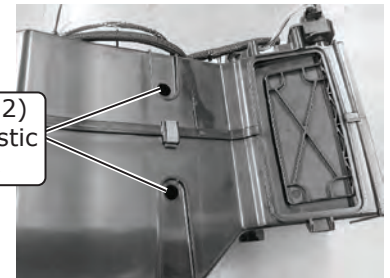


Photo 3

(2) 1/2" plastic plugs

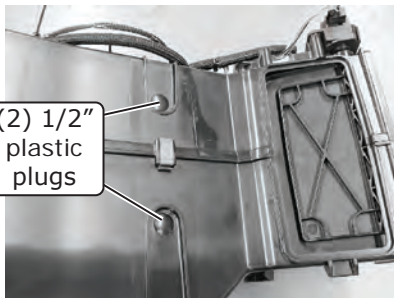


Photo 4

Install upper heater hardline onto evaporator module with properly lubricated #10 O-ring

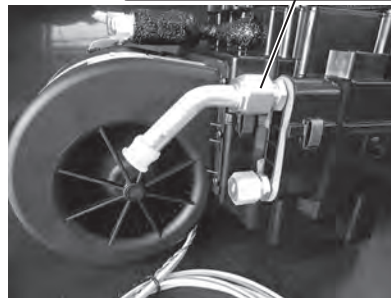


Photo 5

Install lower heater hardline onto evaporator module with properly lubricated #10 O-ring

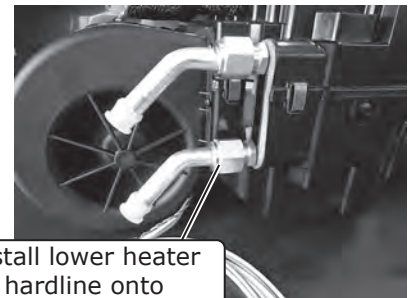


Photo 6

Install evaporator firewall bracket (640717) onto evaporator module

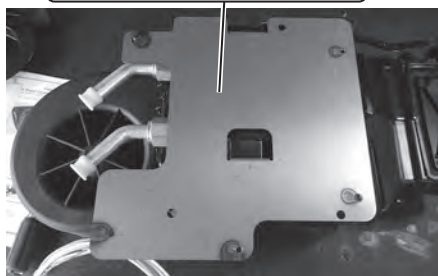


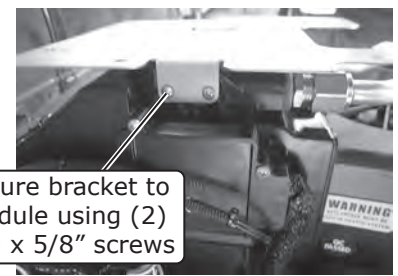
Photo 7

Secure bracket to module using (2) #10 x 5/8" screws



Bottom of Module View  
Photo 8

Secure bracket to module using (2) #10 x 5/8" screws



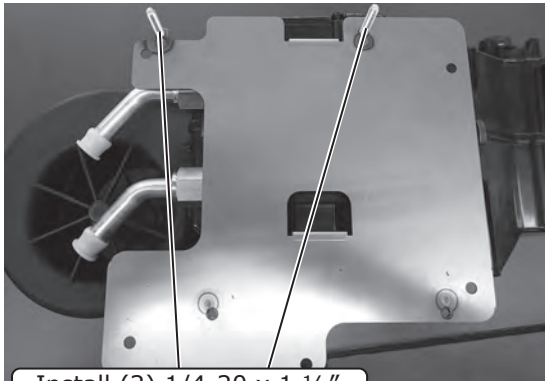
Top of Module View  
Photo 9



www.vintageair.com

## Evaporator Module Preparation (Cont.)

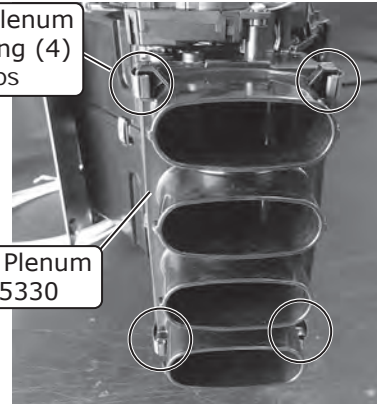
5. Install (2) 1/4-20 x 1 1/2" full-threaded studs into the (2) upper mounting holes on the evaporator firewall bracket (See Photo 10, below). **NOTE: Thread studs in a 1/4" of the way.**
6. Using (4) spring clips, install the dash plenum (See Photo 11, below).
7. Using (2) spring clips, install the floor plenum onto the back of the evaporator module (See Photo 12, below).
8. Using (2) spring clips, install the defrost plenum onto the front of the evaporator module (See Photo 13, below).
9. Loosen the (2) screws holding the ECU (See Photo 14, below), then remove it and let it hang in front of the module. Retighten the mounting screws.



Install (2) 1/4-20 x 1 1/2" full-threaded studs into bracket a 1/4" of the way in

Photo 10

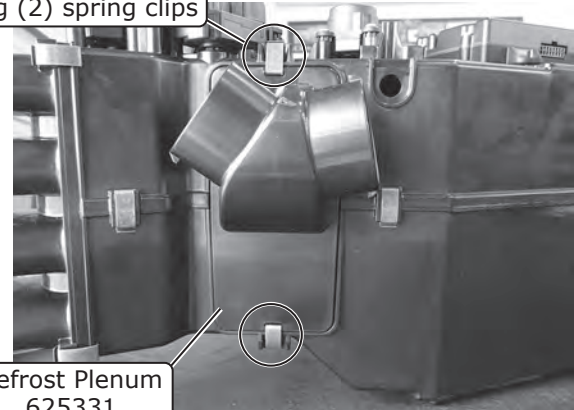
Secure dash plenum to module using (4) spring clips



Dash Plenum 625330

Photo 11

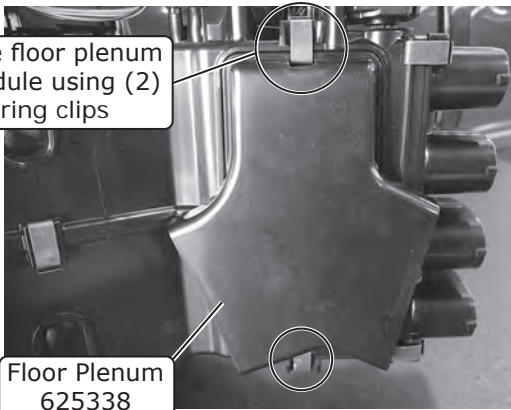
Secure defrost plenum to module using (2) spring clips



Defrost Plenum 625331

Photo 13

Secure floor plenum to module using (2) spring clips



Floor Plenum 625338

Photo 12

Loosen (2) screws securing ECU

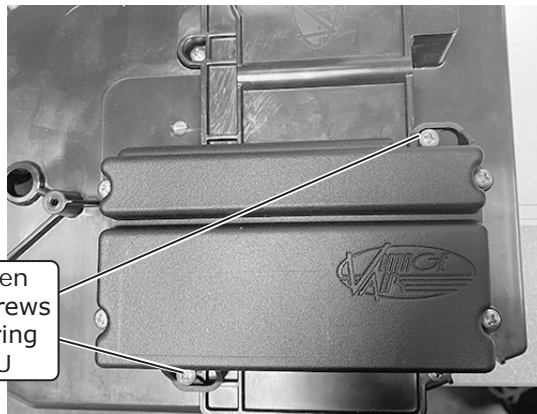


Photo 14



www.vintageair.com

## Fresh Air Cap & Kick Panel Cover Preparation

1. Install (3) large, (1) 1 1/4" O.D. and (1) 7/8" O.D. grommets into the fresh air cap (See Photos 1 & 2, below).
2. Install (3) large, (1) 1 1/4" O.D. and (1) 7/8" O.D. grommets into the kick panel cover (See Photos 3 & 4, below).

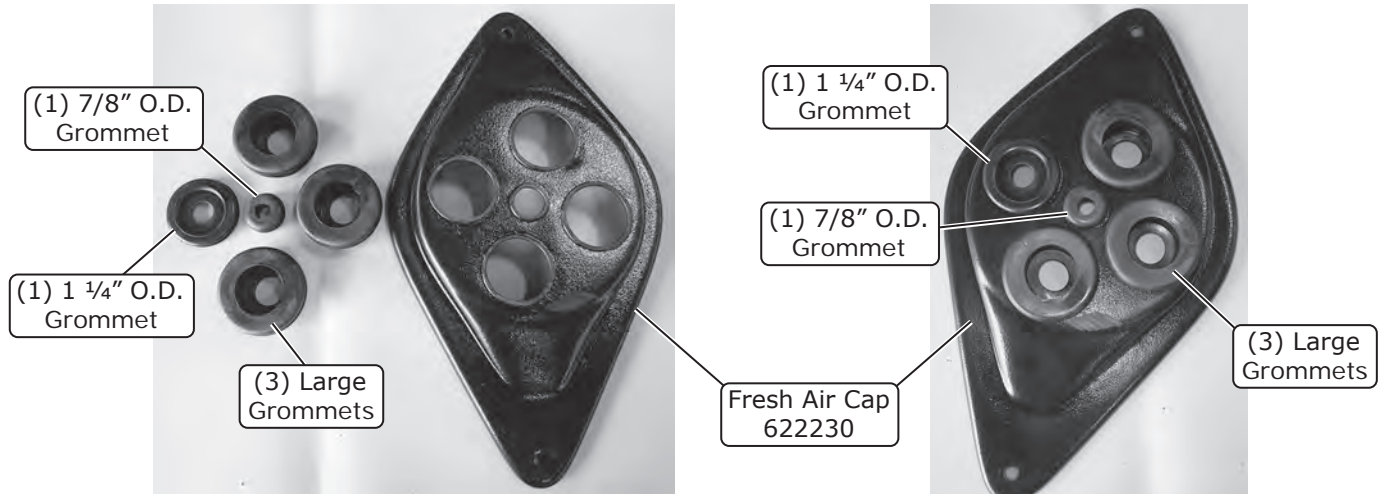


Photo 1

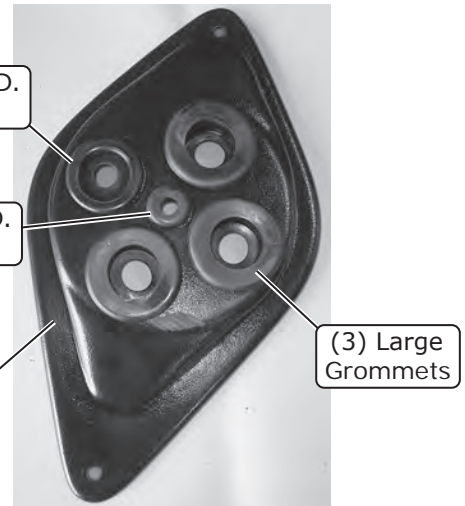


Photo 2

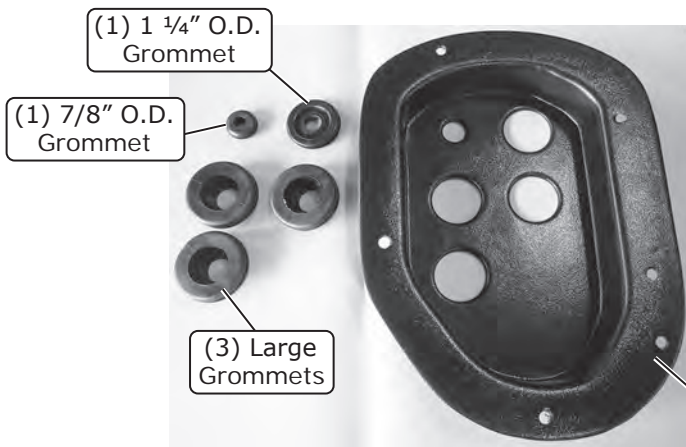


Photo 3

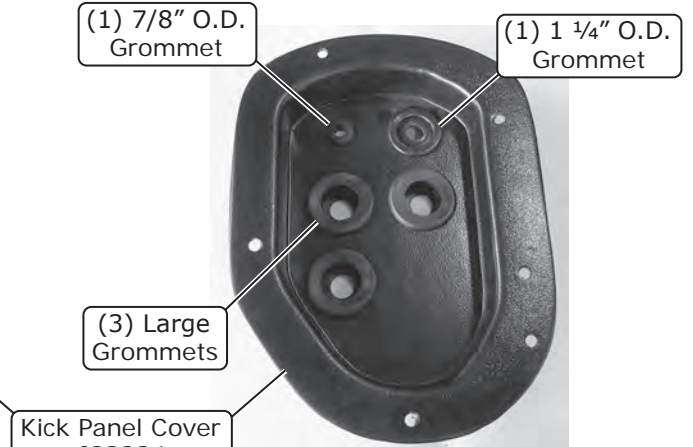


Photo 4

## Heater and A/C Hose Installation

**NOTE:** Soapy water may be used to ease insertion of A/C and heater hoses through the grommets, but be sure the hoses are capped to prevent water from getting inside.

1. On the inside of the fresh air cap, the letter "T" indicates the top mounting hole for the firewall (See Photo 1, below).

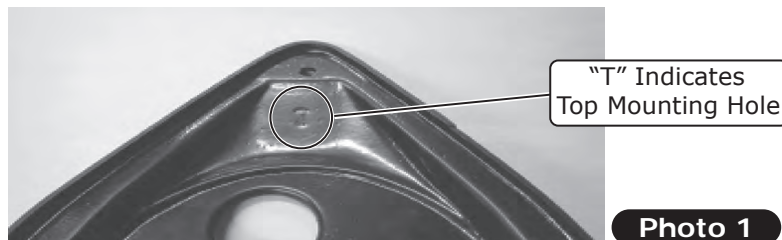


Photo 1

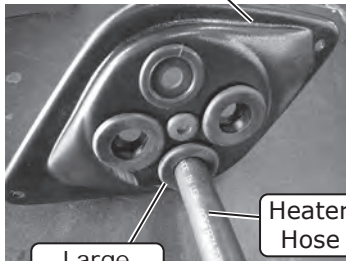


www.vintageair.com

## Heater and A/C Hose Installation (Cont.)

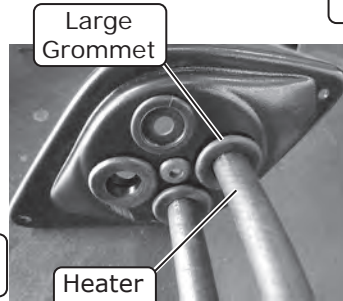
2. Insert a length of heater hose through the bottom-right large grommet on the fresh air cap (See Photo 2, below).
3. Insert a length of heater hose through the top-right large grommet on the fresh air cap (See Photo 3, below).
4. Insert the 45° fitting on the #10 compressor/evaporator A/C hose through the bottom-left large grommet on the fresh air cap (See Photo 4, below). **NOTE: Temporarily remove the large grommet from the fresh air cap to ease insertion of the #10 hose fitting.**
5. Insert the 45° fitting on the #6 drier/evaporator A/C hose through the top-left 1 1/4" O.D. grommet on the fresh air cap (See Photo 5, below).
6. From the passenger compartment, insert the lower heater hose through the bottom-left large grommet on the kick panel cover (See Photo 6, below).
7. Insert the upper heater hose through the top-left large grommet on the kick panel cover (See Photo 7, below).
8. Insert the #10 compressor/evaporator A/C hose through the bottom-right grommet on the kick panel cover (See Photo 8, below). **NOTE: Temporarily remove the grommet from the kick panel cover for easier insertion.**
9. Insert the #6 drier/evaporator A/C hose through the top-right large grommet on the kick panel cover (See Photo 9, below).

Fresh Air Cap  
622230



Large Grommet

Heater Hose



Large Grommet

Heater Hose

Remove large grommet  
for easier insertion

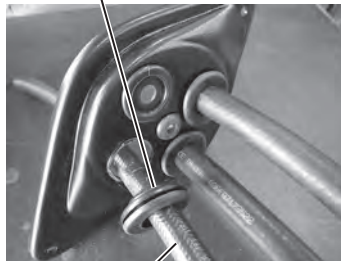
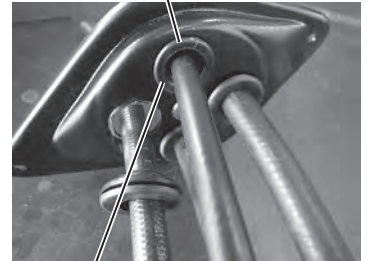


Photo 2

Photo 3

#10 Compressor/  
Evaporator A/C Hose

#6 Drier/Evaporator  
A/C Hose

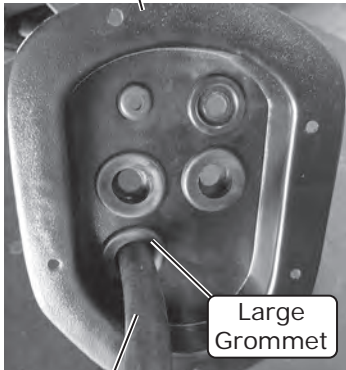


1 1/4" O.D.  
Grommet

Photo 4

Photo 5

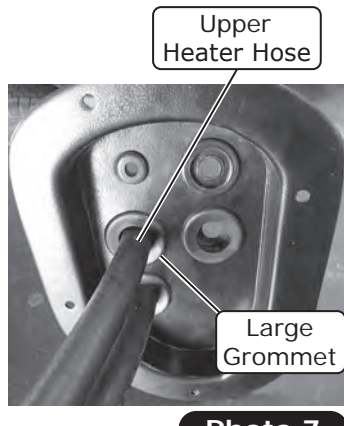
Kick Panel Cover  
622234



Large Grommet

Lower  
Heater Hose

Photo 6

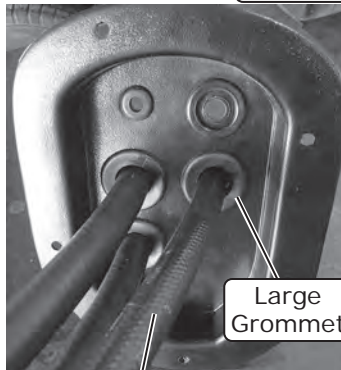


Upper  
Heater Hose

Large Grommet

Photo 7

#6 Drier/Evaporator  
A/C Hose



Large Grommet

Photo 8

#10 Compressor/  
Evaporator A/C Hose

1 1/4" O.D.  
Grommet

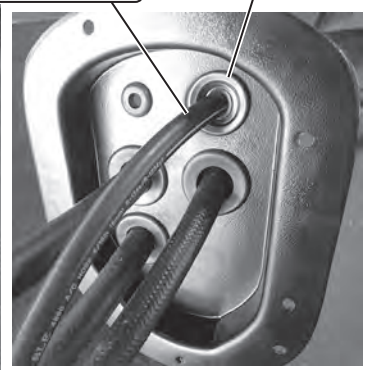


Photo 9

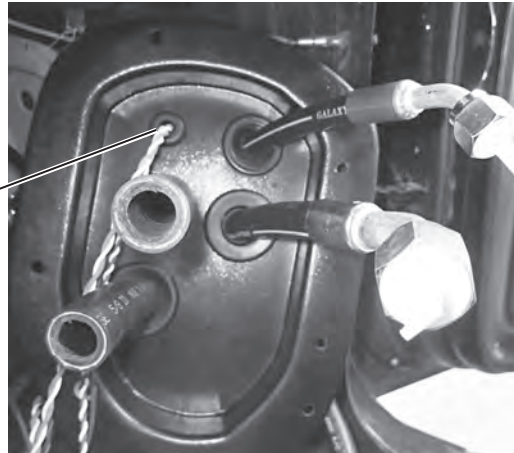


www.vintageair.com

## Wiring Installation

1. From the passenger compartment, route the heater control valve connector and wiring (white, yellow and purple), and the red, white and blue wires from the main wiring harness through the 7/8" O.D. grommet on the kick panel cover and into the 7/8" O.D. grommet on the fresh air cap (See Photo 1, below). **NOTE: Leave approximately 5" of wiring between the relay and the kick panel cover. This is to allow enough wiring to secure the relay to the mounting position.**
2. Place the evaporator module on the passenger-side floorboard and route the orange and white wires through the 7/8" O.D. grommet on the kick panel cover, then through the 7/8" O.D. grommet on the fresh air cap.

Route heater control valve connector and wiring (white, yellow and purple), and red, white and blue wires from main wiring harness through 7/8" O.D. grommet on kick panel cover and into 7/8" O.D. grommet on fresh air cap



**NOTE: Leave approximately 5" of wiring between relay and kick panel cover to allow enough wiring to secure relay to mounting position.**

Photo 1

## Kick Panel Installation

1. Apply a bead of silicone around the mating surface of the kick panel cover (See Figure 1, below).
2. Install the kick panel cover into place, lining up the mounting holes on the cover with the OEM mounting holes on the kick panel opening.
3. Install the kick panel, routing the hoses and wiring through the opening. Secure the panel using (4) #8 x 1 1/4" countersunk screws with washers (See Photo 1, below). **NOTE: Use only the mounting holes shown in Photo 1, below, at this time.**
4. Using a #8 x 1 1/4" countersunk screw, secure the relay to the upper OEM kick panel mounting hole as shown in Photo 2, below.

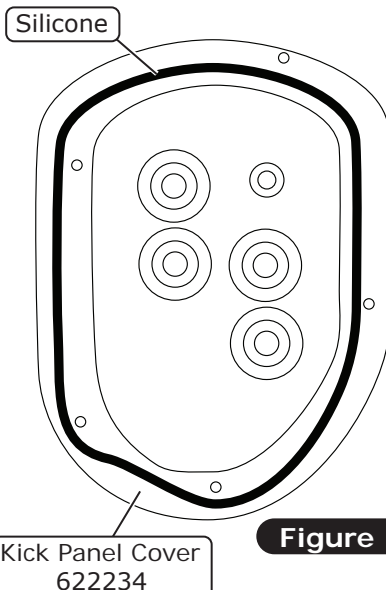
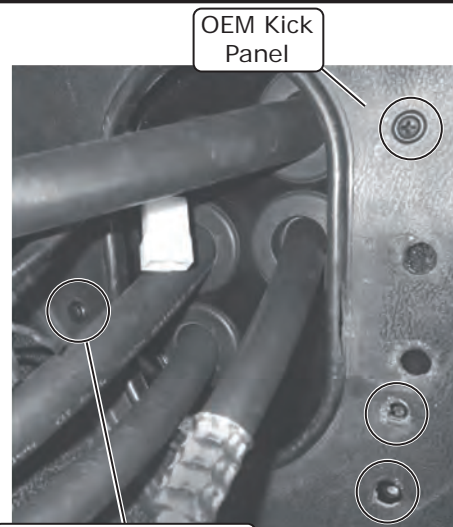


Figure 1



(4) #8 x 1 1/4" Countersunk Screws with Washers

Photo 1

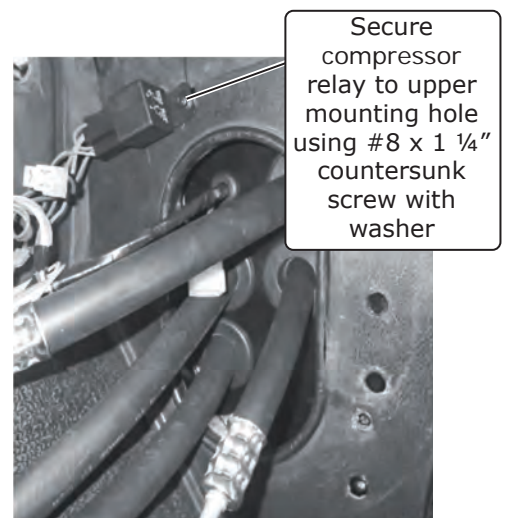


Photo 2



www.vintageair.com

## Evaporator Installation

**NOTE: A 10" block of wood may be used to support the evaporator unit while the following steps are completed. To ensure a watertight seal between the passenger compartment and the vehicle exterior, for all bolts passing through the firewall, Vintage Air recommends coating the threads with silicone prior to installation.**

1. Install the upper heater hose and a hose clamp onto the upper heater hardline on the evaporator module (See Photo 1, below).
2. Install the lower heater hose and a hose clamp onto the lower heater hardline on the evaporator module (See Photo 2, below).
3. Roll the evaporator into it's mounting position. Insert the (2) 1/4-20 x 1 1/2" full-threaded studs into the upper OEM mounting holes on the firewall (See Photo 3, below).
4. Using a properly lubricated #6 O-ring (See Lubricating O-rings, Page 13), install the 45° fitting on the #6 drier/evaporator A/C hose onto the block-valve adapter on the evaporator module (See Photo 4, below).
5. Using a properly lubricated #10 O-ring (See Lubricating O-rings, Page 13), install the 45° fitting on the #10 compressor/evaporator A/C hose onto the #10 fitting on the block-valve adapter on the evaporator module (See Photo 5, below). **NOTE: After installing the #10 compressor/evaporator A/C hose, wrap all exposed metal with the supplied press tape (See Photo 6, below).**

Install upper heater hose onto upper heater hardline



Photo 1

Install lower heater hose onto lower heater hardline

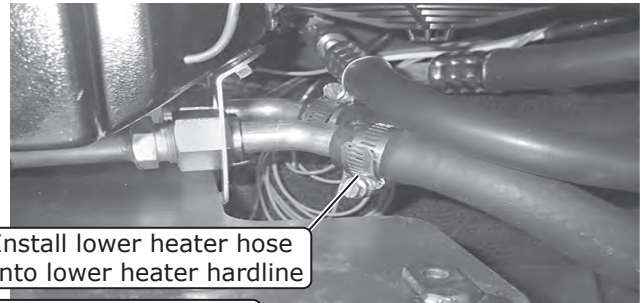


Photo 2

Install 45° fitting on #6 drier/evaporator A/C hose onto block-valve adapter

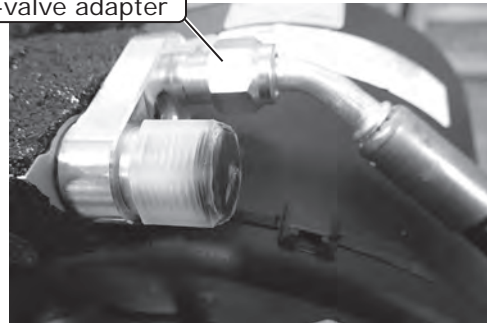


Photo 4

Insert (2) 1/4-20 x 1 1/2" full-threaded studs into upper OEM mounting holes on firewall

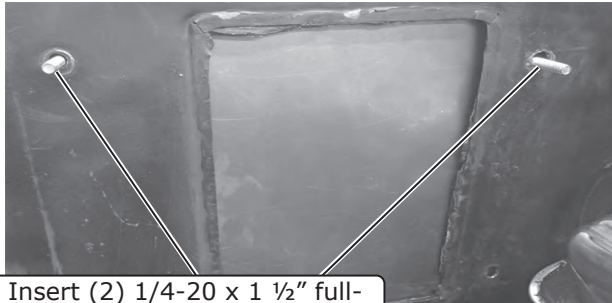


Photo 3

Install 45° fitting on #10 compressor/evaporator A/C hose onto block-valve adapter

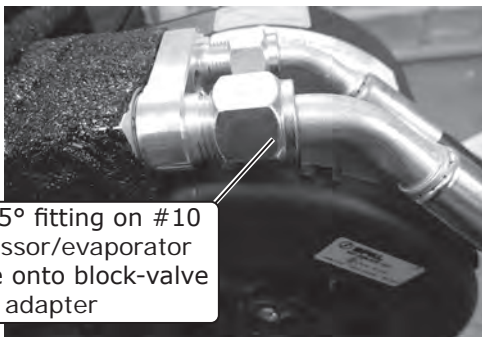


Photo 5

Wrap all exposed metal with supplied press tape

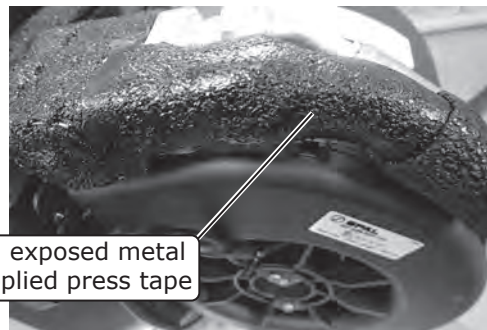


Photo 6



www.vintageair.com

## Evaporator Installation (Cont.)

6. Install (2) 1/4-20 well nuts onto the evaporator module (See Photo 7, below).
7. Install (2) #8 U-nuts onto the evaporator dash bracket (See Photo 8, below).
8. Position the evaporator dash bracket under the glove box door mounting holes, then secure it onto the evaporator unit using (2) 1/4-20 x 1" serrated flange bolts (See Photo 9, below).

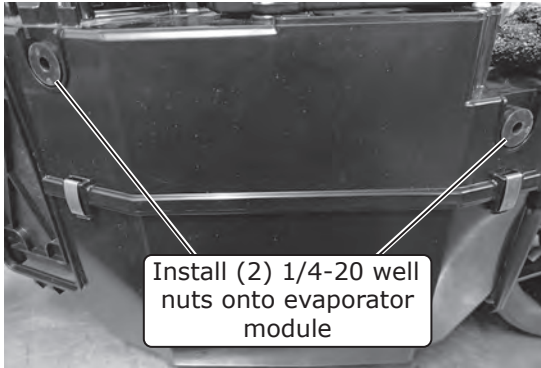
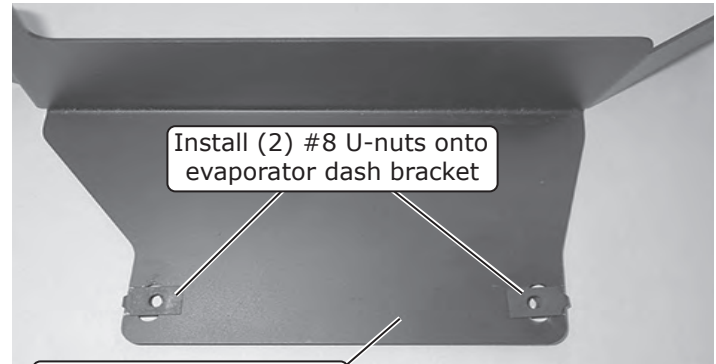


Photo 7



Evaporator Dash Bracket  
640710

Photo 8

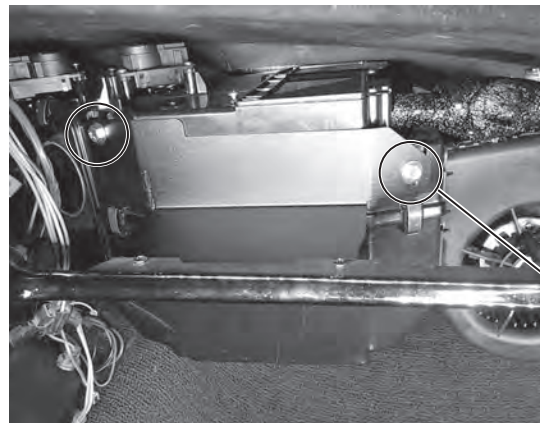


Photo 9

## Drain Hose Installation

1. Install the drain hose through the previously drilled 5/8" hole in the firewall. Attach the drain hose onto the drain outlet on the bottom of the evaporator module (See Photo 1, below).

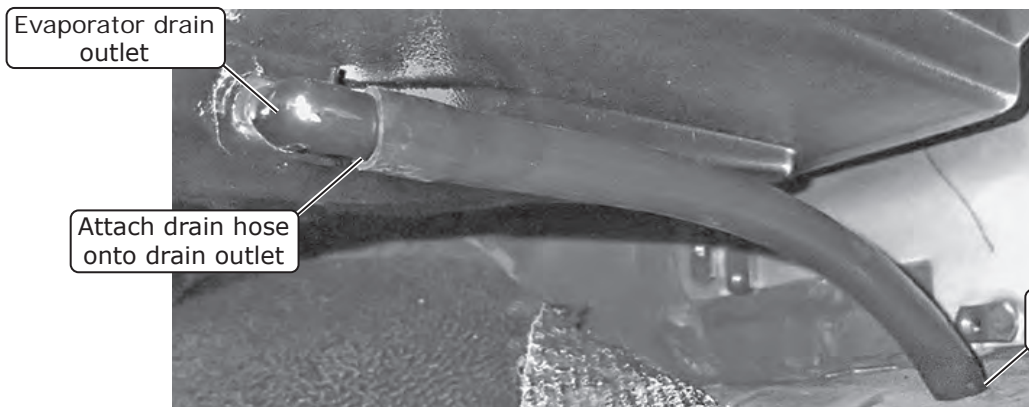


Photo 1



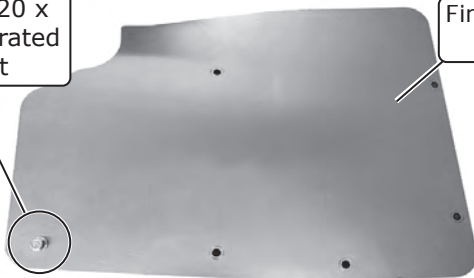
www.vintageair.com

## Firewall Cover Installation

**NOTE:** To ensure a watertight seal between the passenger compartment and the exterior, for all bolts passing through the firewall, Vintage Air recommends coating the threads with silicone prior to installation.

1. Locate the bottom-left mounting hole on the firewall cover, and install a 1/4-20 x 3/4" bolt and a 1/4" pushnut retainer (See Photo 1, below).
2. Apply a bead of silicone around the mating surface of the firewall cover as shown in Photo 2, below.
3. Install the firewall cover onto the (2) 1/4-20 x 1 1/2" full-threaded studs, then secure it using (2) 1/4-20 nuts with star washers (See Photo 3, below).
4. Install (3) 1/4-20 x 3/4" black serrated flange bolts into the remaining open mounting holes on the firewall cover and into the evaporator firewall bracket (See Photo 4, below). **NOTE: Do not tighten at this time.**
5. Remove the (2) 1/4-20 nuts with star washers and (2) 1/4-20 x 1 1/2" full-threaded studs from the firewall cover, and replace them with (2) 1/4-20 x 3/4" black serrated flange bolts (See Photo 5, below).
6. Install (1) of the previously removed 1/4-20 nuts with star washers onto the bottom-right firewall cover bolt in the passenger compartment (See Photo 6, below).
7. Verify the evaporator unit is level and square to the dash. **NOTE: To ensure proper drainage, it is very important that the evaporator is level, both left-right and fore-aft. Check for level on the flat portions of the case around the drain.**
8. Tighten all of the mounting bolts at this time. **NOTE: Tighten the bolts on the firewall first. Adjust the evaporator dash bracket as needed, then tighten the bolts on the evaporator unit. Silicone or seam sealer may be applied around the outer edge of the firewall cover.**

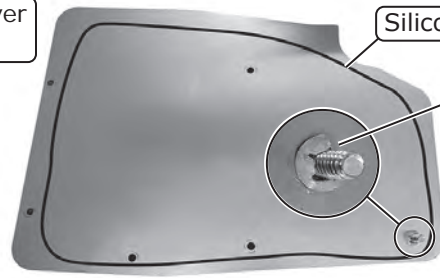
Install a 1/4-20 x 3/4" black serrated flange bolt



Engine Compartment Side View

Photo 1

Firewall Cover 640684



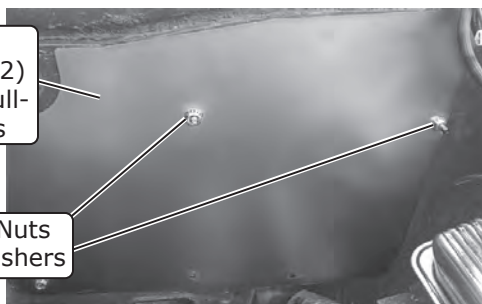
Passenger Compartment Side View

Photo 2

Silicone

1/4" Pushnut Bolt Retainer

Install firewall cover onto the (2) 1/4-20 x 1 1/2" full-threaded studs



Engine Compartment View

Photo 3

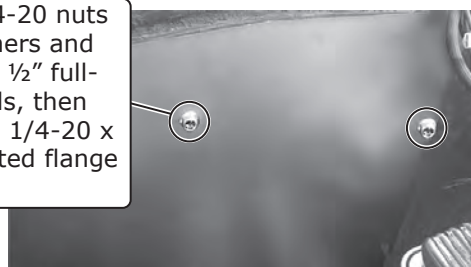
(2) 1/4-20 Nuts with Star Washers



Photo 4

Install (3) 1/4-20 x 3/4" black serrated flange bolts

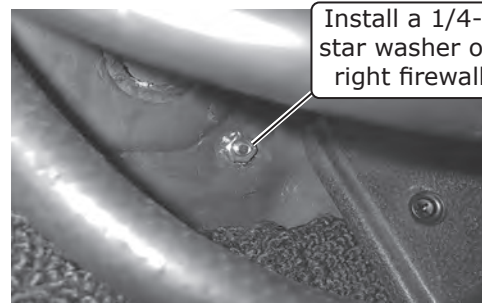
Remove (2) 1/4-20 nuts with star washers and (2) 1/4-20 x 1 1/2" full-threaded studs, then replace with (2) 1/4-20 x 3/4" black serrated flange bolts



Engine Compartment View

Photo 5

Install a 1/4-20 nut with star washer onto bottom-right firewall cover bolt



Passenger Compartment View

Photo 6

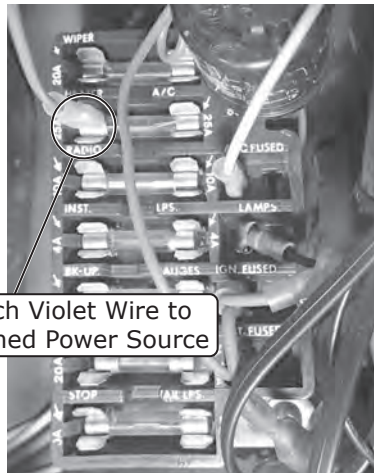




www.vintageair.com

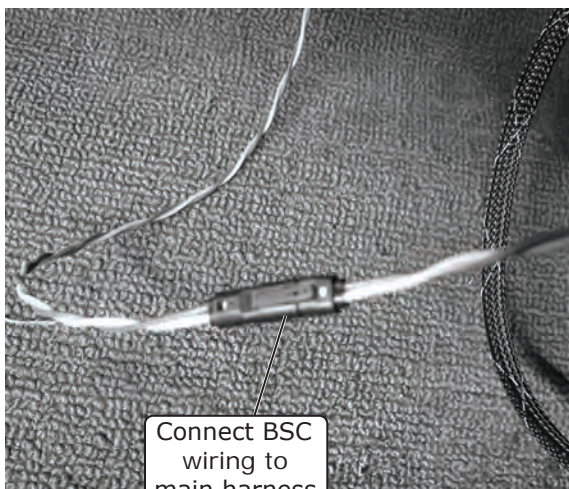
## Passenger Compartment Wiring

1. Select a suitable ground location for the white ground wire eyelet from the heater control valve harness, and secure it using a #10 x 1/2" sheet metal screw.
2. Route the violet power wire to a switched 12v power source on the fuse panel (See Photo 1, below).  
**NOTE: This requires a male fuse extension (not supplied).**
3. Connect the tan wire to the factory dash lights to enable control panel backlighting (if applicable).
4. Connect the BSC wiring to the main harness (See Photo 2, below).
5. Connect the main harness to the ECU (See Photo 3, below).



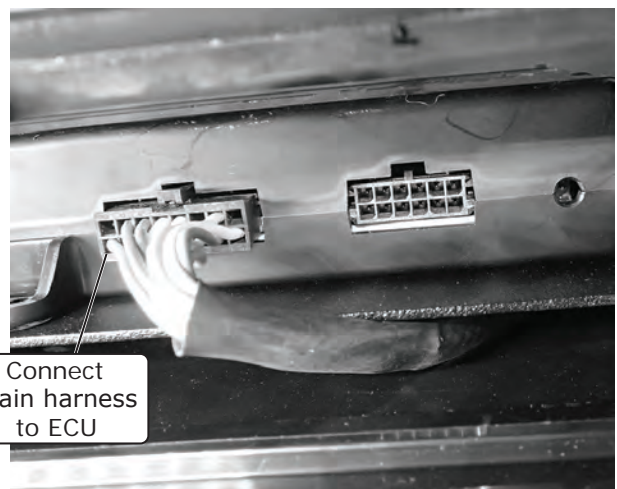
Attach Violet Wire to Switched Power Source

Photo 1



Connect BSC wiring to main harness

Photo 2



Connect main harness to ECU

Photo 3



www.vintageair.com

# ECU, Control Panel & Duct Hose Routing

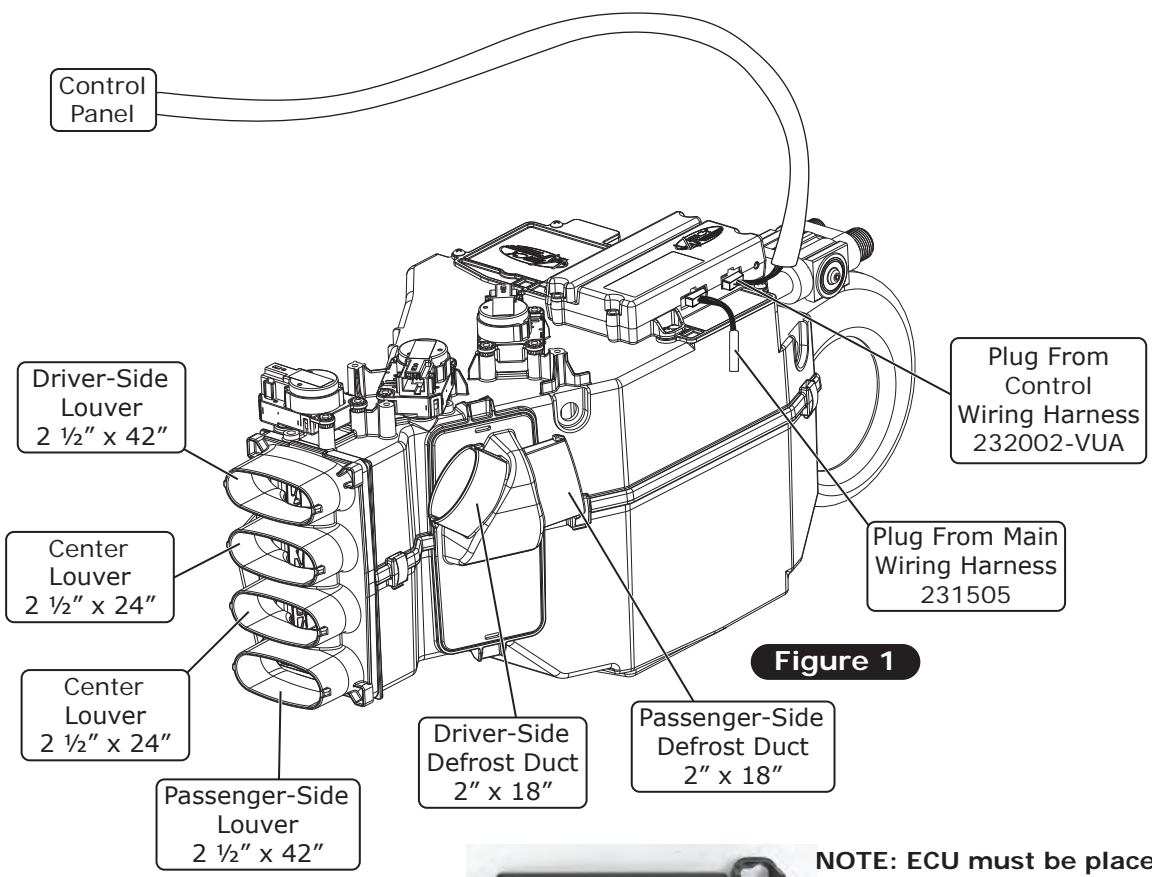
**NOTE:** For the system to function optimally, the duct hoses must be routed as directly as possible, taking care to avoid kinks, sharp bends and unnecessary length. Vintage Air supplies duct hoses in continuous lengths that will need to be cut to size depending on application. Before cutting, familiarize yourself with the installation instructions and verify the routing will work with your application. For custom hose routing, additional hose may be needed and can be purchased from Vintage Air.

1. Stretch the duct hose until there is no slack, measure, mark and cut hose to size (See Photo 1, below).



Stretch, measure, mark and cut hose to size

**Photo 1**



**Figure 1**



**NOTE:** ECU must be placed away from water and humidity, and also be accessible for servicing. If relocating, connectors must be positioned towards the bottom.

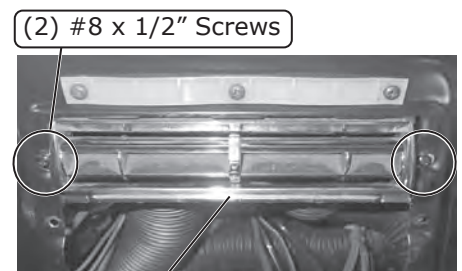
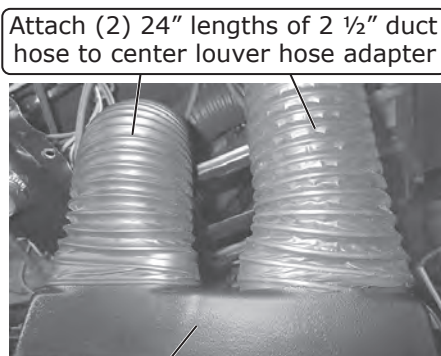
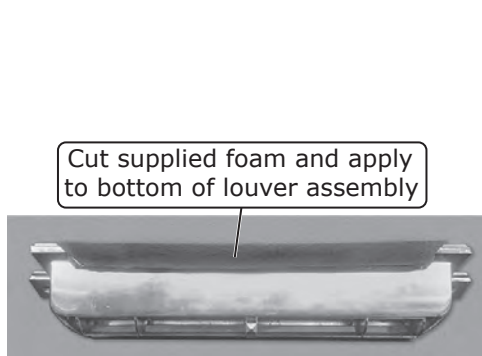
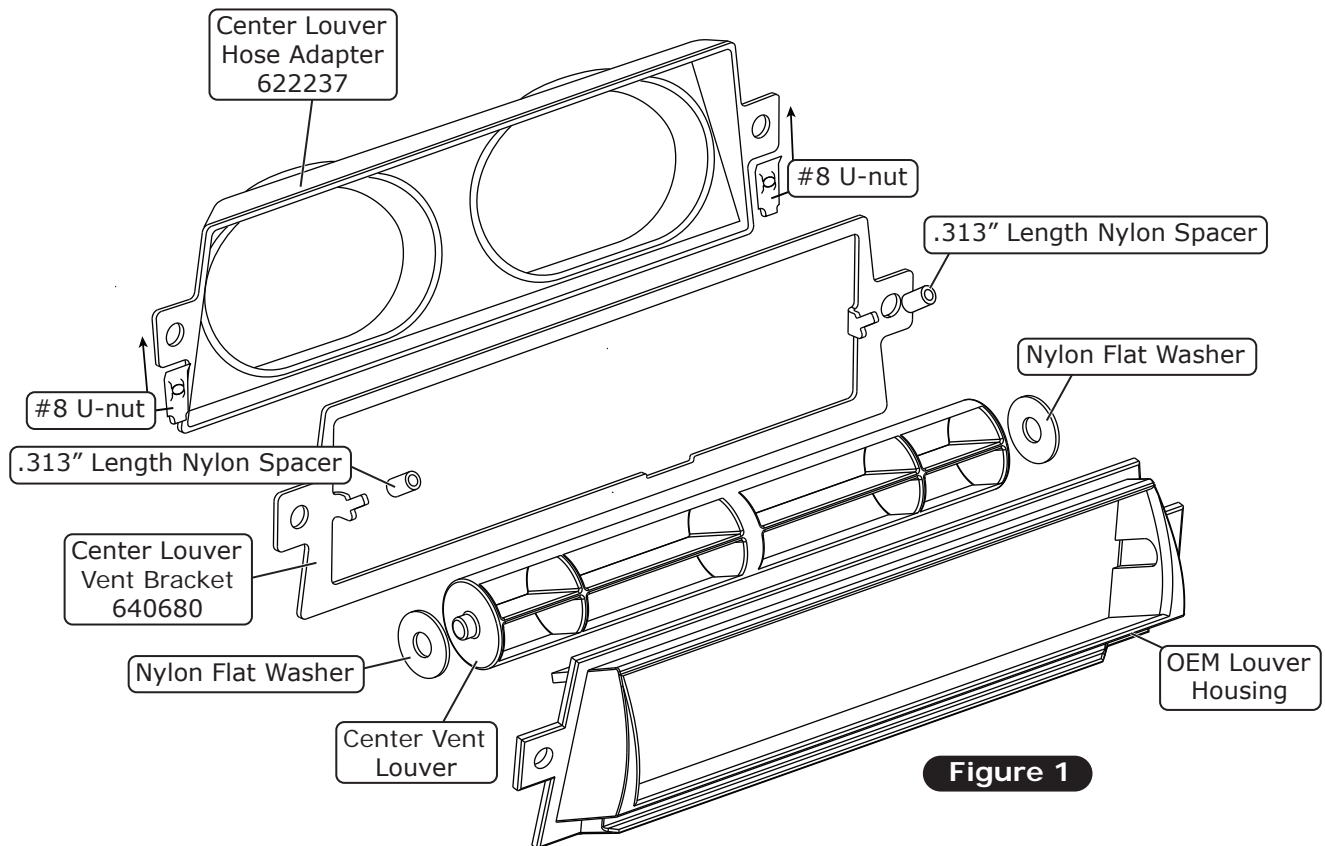
Position connectors towards bottom



www.vintageair.com

## Center Louver Installation

1. Install (2) #8 U-nuts onto the center louver hose adapter (See Figure 1, below).
2. Install (2) .313" length nylon spacers onto the tabs of the center louver vent bracket (Figure 1, below).
3. Install (2) nylon flat washers onto the center vent louver (See Figure 1, below).
4. Insert the center vent louver into the OEM louver housing. Install the center louver vent bracket with (2) nylon spacers onto the housing (See Figure 1, below).
5. Cut a piece of supplied foam, and apply it to the bottom of the louver assembly (See Photo 1, below)
6. Attach (2) 24" lengths of 2 1/2" duct hose to the center louver hose adapter (See Photo 2, below).
7. While holding the center louver assembly and the center louver hose adapter together, align the assembly holes with the holes on the dash. Secure the assembly using (2) #8 x 1/2" screws (See Photo 3, below).



Center Louver Hose Adapter 62237

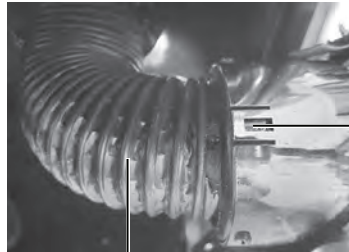
Install center louver assembly into dash



www.vintageair.com

## Driver- & Passenger-Side Louver Installation

1. Attach a 42" length of 2 1/2" duct hose to the driver-side louver, then install it into the dash (See Photo 1, below).
2. Attach a 42" length 2 1/2" duct hose to the passenger-side louver, then install it into the dash (See Photo 2, below).



Driver-Side Louver

42" Length of 2 1/2" Duct Hose

Photo 1



Passenger-Side Louver

Photo 2

## Control Panel Installation

1. From the driver side, install the control panel into the dash using the (4) OEM screws (See Photo 1, below).
2. Connect the control panel wiring harness to the ECU (See Photo 2, below).

(4) OEM screws



Photo 1

Connect control panel wiring harness to ECU

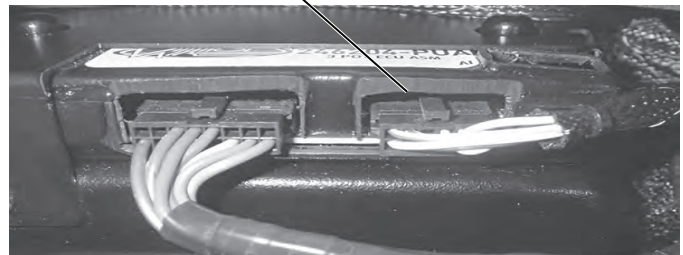


Photo 2

## Fresh Air Cap Installation

1. Gently pull the slack from the hoses in the passenger compartment, making sure the hoses are not kinked.
2. Slide the fresh air cap into position, and secure it to the firewall using (2) #14 x 3/4" washer head screws (See Photo 1, below).
3. Apply silicone around the outer edge of the fresh air cap (See Photo 1, below).

Apply silicone around fresh air cap

Secure fresh air cap with (2) #14 x 3/4" washer head screws

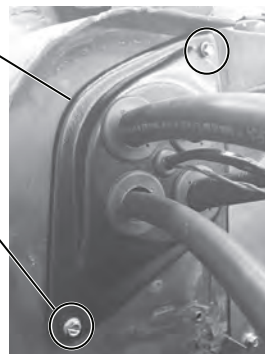


Photo 1



www.vintageair.com

## Inner Fender Cover

1. Apply a bead of silicone around the OEM A/C hose opening (See Figure 1, below).
2. Install the inner fender cover using the (4) OEM screws (See Figure 1, below).

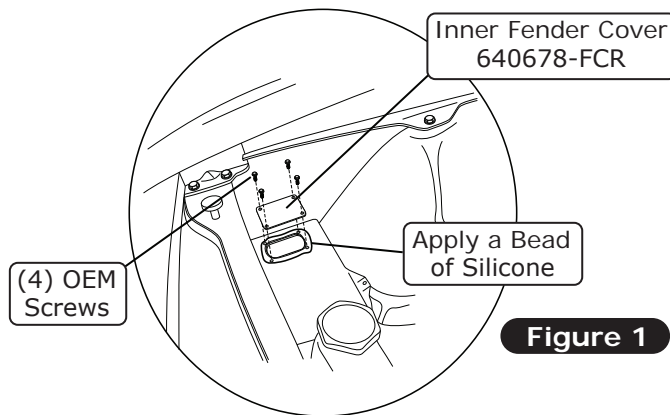


Figure 1

## A/C Hose Installation

### Standard Hose Kit:

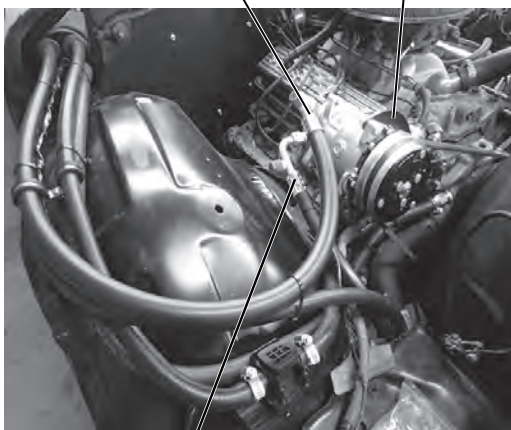
1. Locate the #8 condenser/compressor A/C hose. Lubricate (2) #8 O-rings (See Lubricating O-rings, Page 13), and connect the #8 90° fitting with service port to the #8 discharge port on the compressor (See Photo 1, below). Then, route the 45° fitting to the #8 condenser/core hardline coming from the condenser (See Photo 2, below). Tighten each fitting connection (See Lubricating O-rings, Page 13).
2. Locate the #10 compressor/evaporator A/C hose. Lubricate a #10 O-ring (See Lubricating O-rings, Page 13), and connect the #10 90° fitting with service port to the #10 suction port on the compressor (See Photo 1, below). Tighten the fitting connection (See Lubricating O-rings, Page 13).
3. Locate the #6 drier/evaporator hose. Lubricate a #6 O-ring (See Lubricating O-rings, Page 13), and connect it to the #6 drier/fenderwell hardline coming from the condenser (See Photo 2, below). Tighten the fitting connection (See Lubricating O-rings, Page 13).

### Modified Hose Kit:

1. Refer to separate instructions included with modified hose kit.

#10 Compressor/  
Evaporator A/C Hose  
090176

Compressor

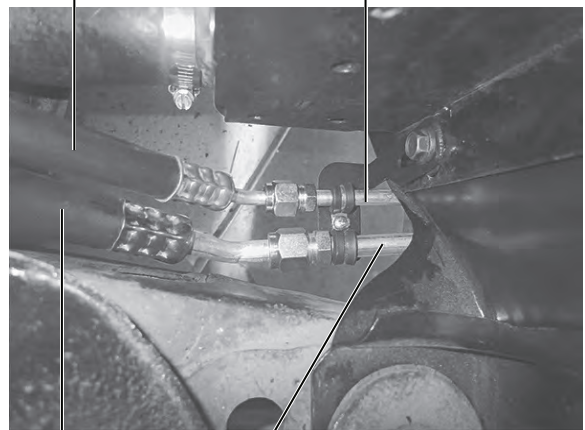


#8 Compressor/  
Evaporator A/C Hose  
090175

Photo 1

#6 Drier/Evaporator A/C Hose  
090174

#6 Drier/Fenderwell Hardline  
090173



#8 Compressor/  
Evaporator A/C Hose  
090175

#8 Condenser/  
Core Hardline  
35367-VCG

Photo 2

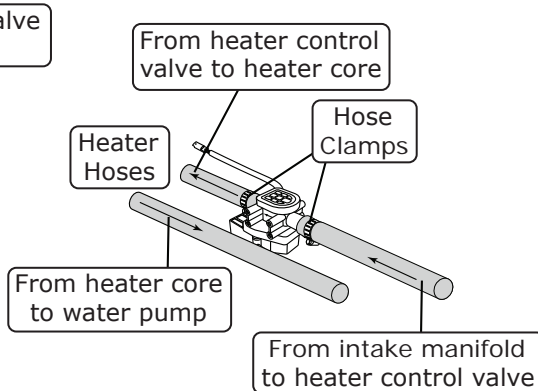
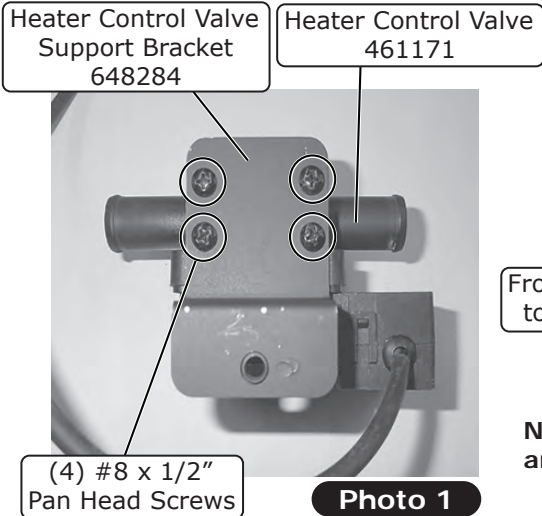


www.vintageair.com

## Heater Control Valve Installation

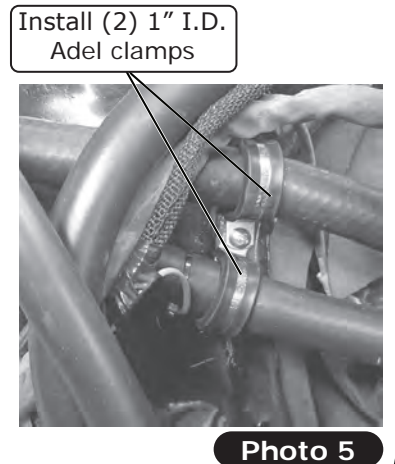
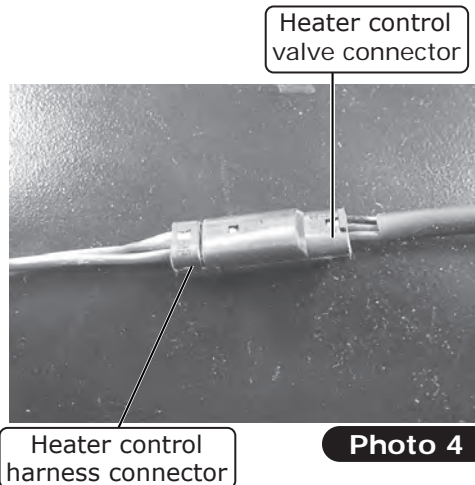
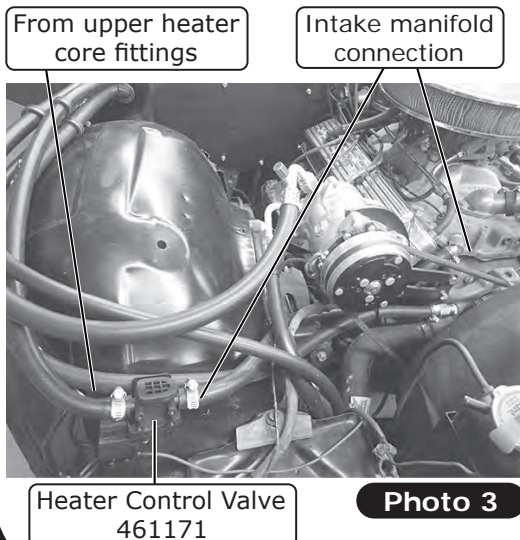
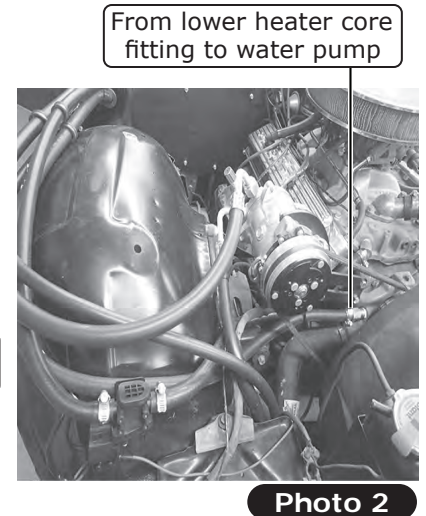
**NOTE: Vintage Air Systems use 5/8" heater connections. On engines equipped with 3/4" hose nipples, these will need to be removed and replaced with 5/8" nipples (not supplied). For water pumps with a cast-in 3/4" heater outlet, a 3/4" x 5/8" reducer fitting (not supplied) or molded hose (Vintage Air Part # 099010) will need to be installed in the heater hose.**

1. Install the heater control valve support bracket onto the heater control valve using (4) #8 x 1/2" pan head screws (See Photo 1, below). **NOTE: Before mounting the heater control valve in the vehicle, ensure the wiring from the main harness and the heater control valve can be connected easily without tension or strain on the connection, or excessive pressure on the metal surfaces.**
2. Route a piece of heater hose (not provided) from the lower heater core fitting to the water pump. Secure using hose clamps (See Photo 2, below).
3. Route a piece of heater hose (not provided) from the intake manifold to the heater control valve. Connect the heater hose from the upper heater core fitting to the heater control valve. Secure using hose clamps (See Figure 1 and Photo 3, below). **NOTE: Ensure proper flow direction through the heater control valve (the flow direction follows the molded arrow on the valve).**
4. Plug the heater control valve connector into the connector on the main wiring harness (See Photo 4, below).
5. Install (2) 1" I.D. Adel clamps to secure the heater hoses (See Photo 5, below). **NOTE: Use an OEM hole to mount the Adel clamps. If an OEM hole is not available, a new hole will need to be drilled. Be sure all hoses are routed away from the fan, belts and pulleys.**



**NOTE: Flow direction follows molded arrow on valve.**

**Figure 1**



# Quality Crimp Guideline

Acceptable strip length  
(Some copper visible)

Crimped area is centered  
on each side of splice

Bad strip length  
(Too much copper visible)  
Visible copper should be  
just enough to ensure  
clearance between splice  
area and wire insulation

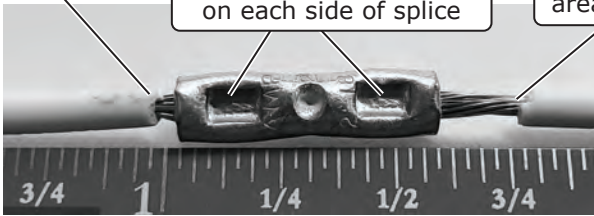


Photo 1

A good crimp requires  
seam of butt splice to be  
opposite of crimp die tooth

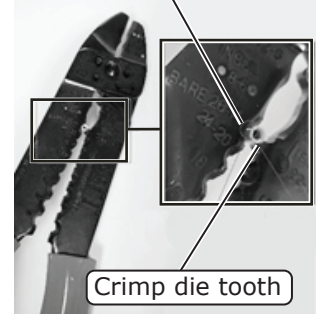


Photo 2

## Good Ring Terminal Crimp    Bad Ring Terminal Crimp

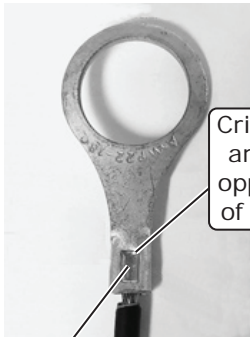


Photo 3

Crimp area is centered on barrel

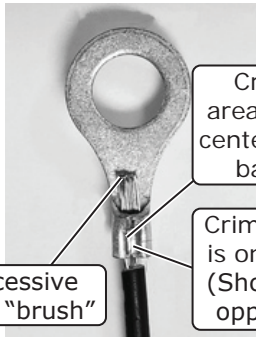


Photo 4

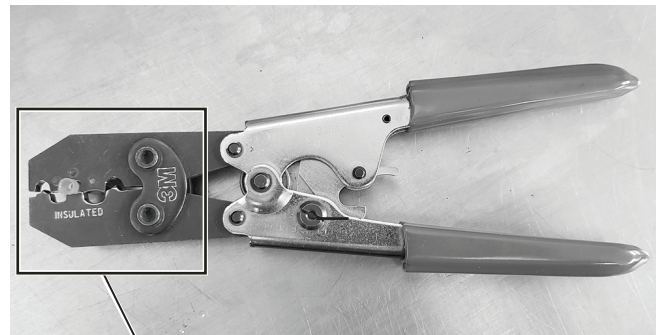


Photo 5

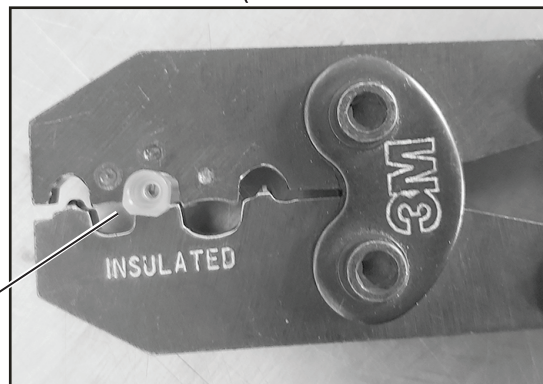


Photo 5a

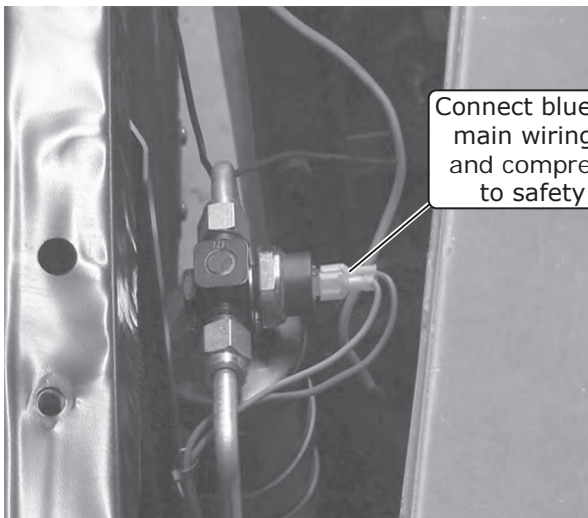
Use a ratcheting crimp tool for insulated barrel terminals when crimping the provided female insulated terminal. Ensure terminal is inserted in appropriate position before crimping.



www.vintageair.com

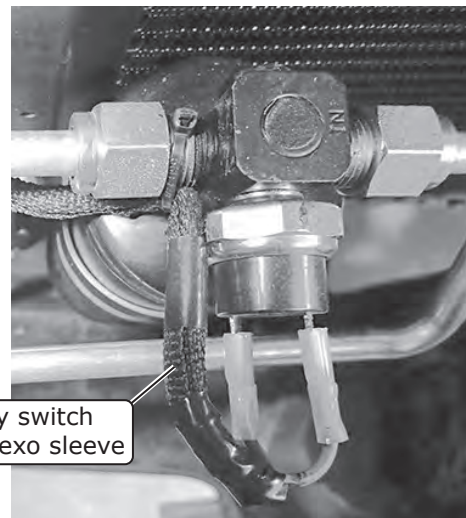
## Engine Compartment Wiring

1. Route the blue lead from the main wiring harness to the safety switch (See Photo 1, below).
2. Connect the compressor lead wire to the safety switch (See Photo 1, below).
3. Wrap the safety switch wiring with flexo sleeve, and secure it with the supplied tie wraps (See Photo 2, below).
4. Route power and ground wires toward the battery.
5. Install the supplied heat shrink over the 12 AWG orange fuse holder assembly wire, and crimp it to the 12 AWG orange wire from the main wiring harness (See Photo 3, below and Quality Crimp Guidelines, Page 28).
6. Install the supplied heat shrink over the 16 AWG black fuse holder assembly wire, and crimp it to the 16 AWG red wire from the main wiring harness (See Photo 4, below and Quality Crimp Guidelines, Page 28).



Connect blue lead from main wiring harness and compressor lead to safety switch

Photo 1



Wrap safety switch wiring with Flexo sleeve

Photo 2

Install supplied heat shrink over 12 AWG orange fuse holder assembly and crimp to 12 AWG orange wire from main wiring harness

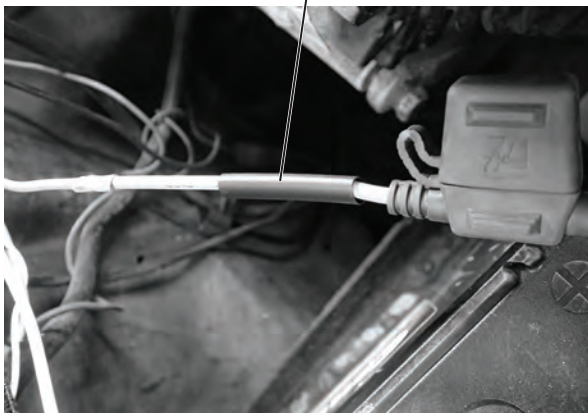


Photo 3

Install supplied heat shrink over 16 AWG black fuse holder assembly wire and crimp to 16 AWG red wire from main wiring harness

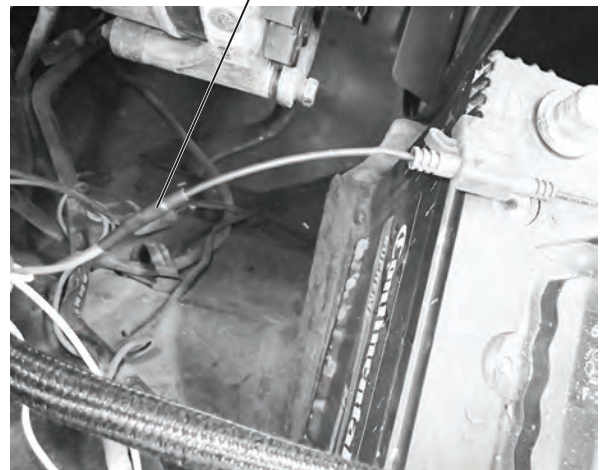


Photo 4





www.vintageair.com

## Engine Compartment Wiring (Cont.)

7. Install fuses into the holders (See Photo 5, below).
  8. Install the supplied heat shrink over the white ground wires, then crimp on the supplied eyelets (See Photos 6 and 7, below and Quality Crimp Guidelines, Page 28)
  9. Connect the ground wiring eyelets to the negative battery terminal connector (See Photo 8, below).
  10. Connect the positive wiring eyelets to the positive battery terminal connector (See Photo 9, below).
- NOTE: Do not connect power until installation is completed.**



Photo 5

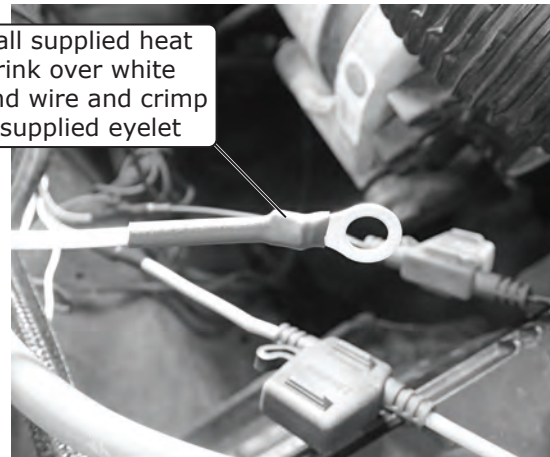


Photo 6

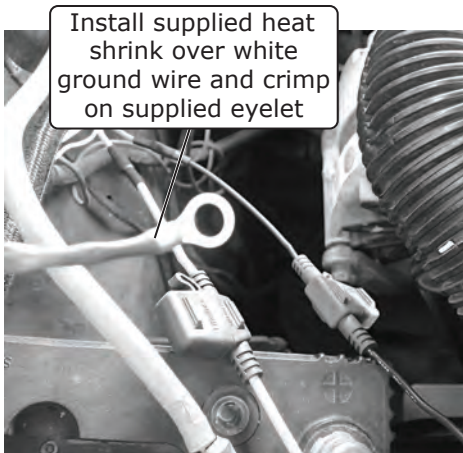


Photo 7

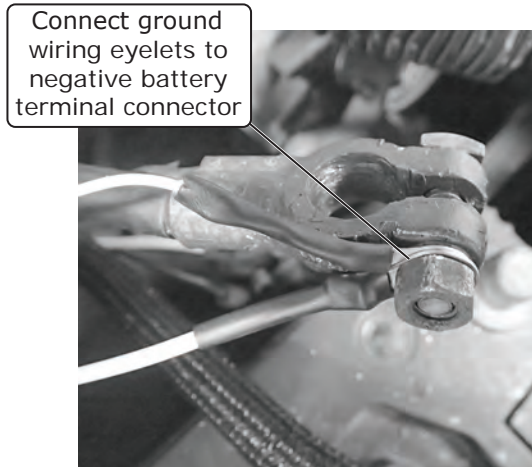


Photo 8

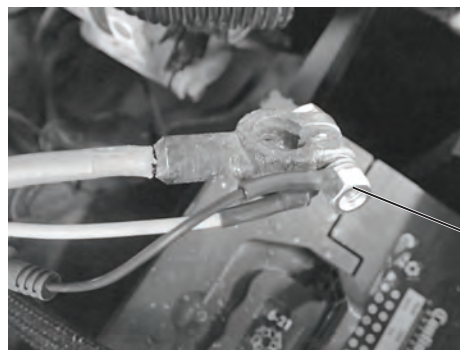


Photo 9

**NOTE: Do not connect power until installation is completed.**

Connect positive wiring eyelets to positive battery terminal connector



www.vintageair.com

# Final Steps: Installation Check

Installation Check	
ITEM TO CHECK	Procedure
<input type="checkbox"/>	<p>ECU</p> <p>If no blinking is observed after 1 minute of turning the ignition on, go to the next check.</p> <p>If repetitive blinking is observed, go to the <b>Advanced Diagnostics</b> Section to diagnose.</p>
<input type="checkbox"/>	<p>Blower speed control</p> <p>Set the blower speed control to <b>OFF</b>, <u>confirm that the blower is off</u>.</p> <p>Position the blower speed control to <b>LOW</b> then <b>MEDIUM</b> and then <b>HIGH</b>. <u>At each setting confirm that the blower speed increases</u>, do this by feeling for the amount of air coming from the unit and hearing the blower speed increase.</p>
<input type="checkbox"/>	<p>Mode control</p> <p>Set the <b>MODE</b> control to the <b>DASH</b> position. <u>Confirm that air is being blown at the dash vents.</u></p> <p>Set the <b>MODE</b> control to the <b>FLOOR</b> position. <u>Confirm that air is being blown at the floor vents.</u></p> <p>Set the <b>MODE</b> control to the <b>DEFROST</b> position. <u>Confirm that all air is being blown from the defrost vents</u></p> <p><b>If heater lines are installed:</b></p> <p>Set the <b>MODE</b> control to the <b>DASH</b> position. Set the <b>TEMP</b> control to the <b>MAX HEAT</b> position. <u>Confirm that HOT air is coming from the dash vents.</u></p>
<input type="checkbox"/>	<p>Temperature control</p> <p><b>If system is charged:</b></p> <p>Set the <b>TEMP</b> control to the <b>MAX COOL</b> position. <u>Confirm that COLD air is coming from the dash vents.</u></p> <p>Also <u>confirm that the compressor "clicks" on</u> when adjusting the <b>TEMP</b> control from the <b>MAX HEAT</b> position to the <b>MAX COOL</b> position.</p>
<input type="checkbox"/>	<p>AC Indicator (If applicable)</p> <p>While the <b>MODE</b> control is set to the <b>DASH</b> position, and the <b>TEMP</b> control is set to the <b>MAX COOL/MIN HEAT</b> position, <u>confirm that the blue AC Indicator light is on</u>.</p>
<input type="checkbox"/>	<p>Backlight (If applicable)</p> <p>If your control panel has backlight capabilities and has been wired, turn the dash lamp on and <u>confirm that the AC panel's legend is lit</u>.</p>
<input type="checkbox"/>	<p>Fittings</p> <p>Verify AC and Heater fittings are all tight.</p>



www.vintageair.com

## ECU Mounting

1. Select a suitable location behind the dashboard and clean the area where the ECU will be mounted.
2. Apply (2) strips of Velcro onto the back of the ECU (See Photo 1, below) and mount it in the selected location.

Apply (2) strips of Velcro onto the back of ECU

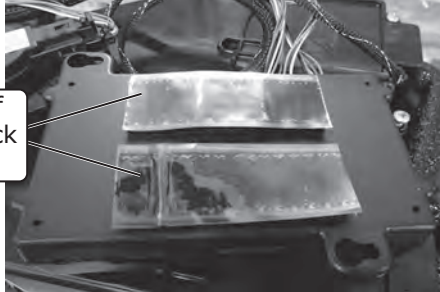


Photo 1

## Glove Box Installation

**NOTE: Before installing the glove box, install a #8 U-nut onto the bottom-right hole on the supplied glove box bottom (See Photo 1, below).**

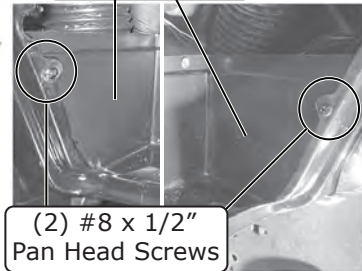
1. Insert the supplied glove box bottom into the glove box opening. Install a #8 x 1/2" pan head screw into the mounting holes on each side of the glove box opening (See Photo 2, below).
2. Insert the glove box top into the glove box opening, then attach the bottom half of the glove box to the top half using (3) 10-32 x 1/2" screws (See Photo 3, below). **NOTE: Route the glove box light wiring through the cutout on the top half of glove box (See Photo 4, below).**
3. Secure the glove box top to the glove box opening using (2) #8 x 1/2" pan head screws (See Photo 5, below).
4. Reinstall the glove box door using (3) #8 x 1/2" pan head screws (See Photo 6, below). **NOTE: When installing the glove box door, be sure the screws install into the #8 U-nuts on the dash bracket.**
5. Install the glove box door latch using (2) OEM screws.
6. Reinstall the glove box door light (See Photo 7, below).

Install #8 U-nut onto glove box bottom



Photo 1

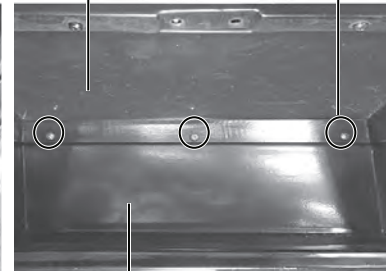
Glove Box Bottom 622231



(2) #8 x 1/2" Pan Head Screws

Photo 2

Glove Box Top 622232



Install (3) 10-32 x 1/2" Screws

Glove Box Bottom 622231

Photo 3

Route wiring through cutout



Photo 4

Secure glove box top using (2) #8 x 1/2" screws



Photo 5

Reinstall glove box door using (3) #8 x 1/2" screws

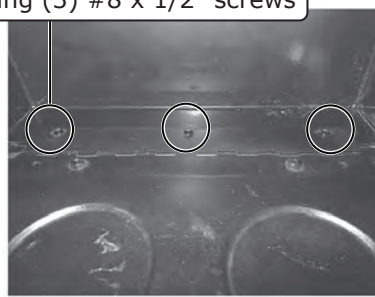


Photo 6

Reinstall glove box light



Photo 7



[www.vintageair.com](http://www.vintageair.com)

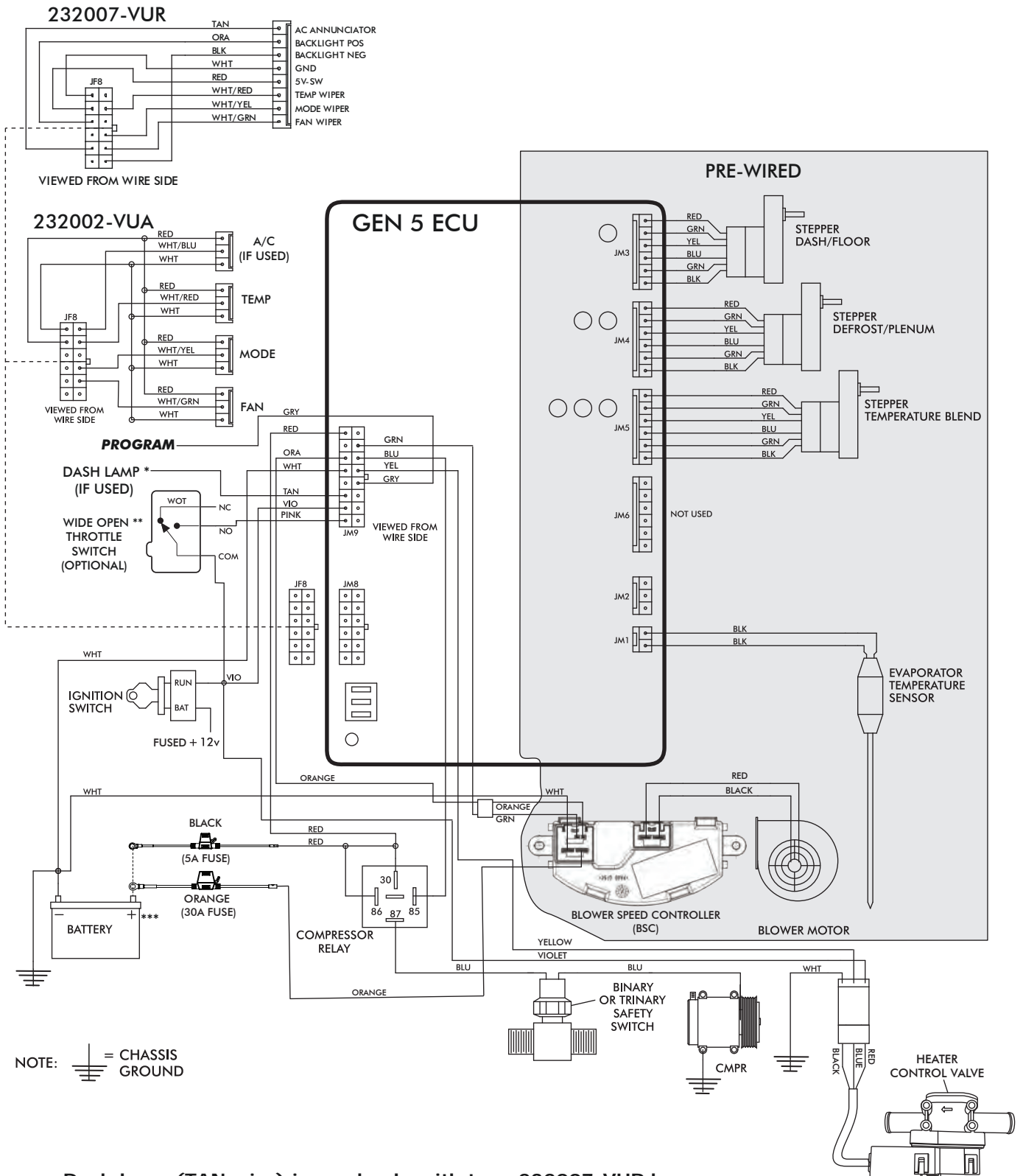
## ***Final Steps: Completing the Install***

1. Reinstall all previously removed items.
2. Fill radiator with at least a 50/50 mixture of approved antifreeze and distilled water. It is the owner's responsibility to keep the freeze protection at the proper level for the climate in which the vehicle is operated. Failure to follow antifreeze recommendations will cause heater core to corrode prematurely and possibly burst in A/C mode and/or freezing weather, voiding your warranty.
3. Double check all fittings, brackets and belts for tightness.
4. Vintage Air recommends that all A/C systems be serviced by a licensed automotive A/C technician.
5. Evacuate the system for a minimum of 45 minutes prior to charging, and perform a leak check prior to servicing.
6. Charge the system to the capacities stated on Page 4 of this instruction manual.
7. See Operation of Controls procedures on Page 39.



www.vintageair.com

# Gen 5 Wiring Diagram



NOTE: = CHASSIS GROUND

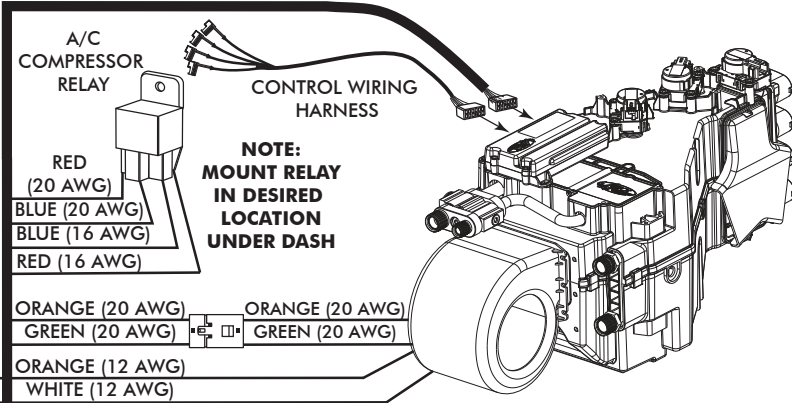
- \* Dash lamp (TAN wire) is used only with type 232007-VUR harness.
- \*\* Wide open throttle switch contacts close only at full throttle, which disables A/C compressor.
- \*\*\* Install fuse assemblies at or as near to the battery as possible.



www.vintageair.com

# Gen 5 Wiring Instructions

WIRING HARNESS (231505) ↓



**NOTE:**  
MOUNT RELAY  
IN DESIRED  
LOCATION  
UNDER DASH

### Ignition Switch:

Using provided butt splice (PN 226004), connect the 20 AWG violet wire to a 5A fused and switched 12V source such as Key On.

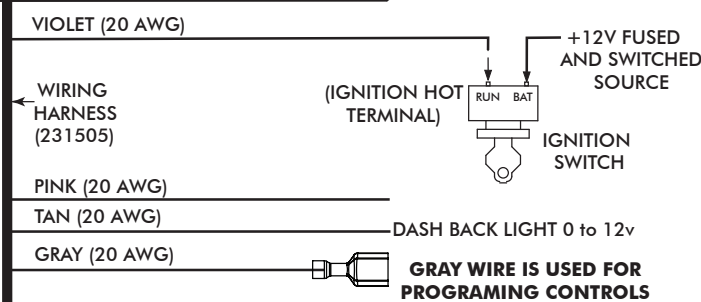
### Wide Open Throttle Switch (Optional):

If a wide open throttle switch is required, connect the 20 AWG pink wire to a normally open switch that, when closed, connects a fused and switched 12V source to the pink wire. See Gen 5 wiring diagram for an example.

### Dash Light (Optional):

If using a Vintage Air control panel with back light, connect the 20 AWG tan wire to the vehicle's dash back light 0-12V using provided butt splice (PN 226004).

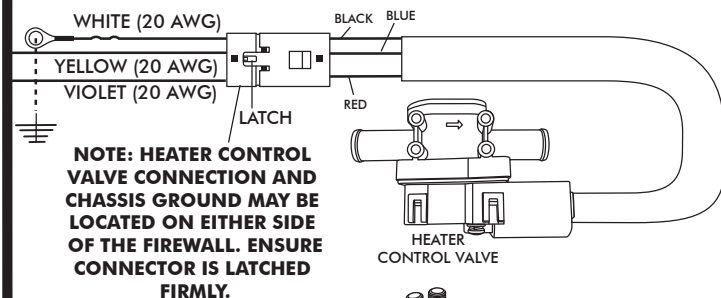
WIRING HARNESS (232020) →



**GRAY WIRE IS USED FOR PROGRAMING CONTROLS IF APPLICABLE**

FIREWALL

FIREWALL



**NOTE: HEATER CONTROL VALVE CONNECTION AND CHASSIS GROUND MAY BE LOCATED ON EITHER SIDE OF THE FIREWALL. ENSURE CONNECTOR IS LATCHED FIRMLY.**

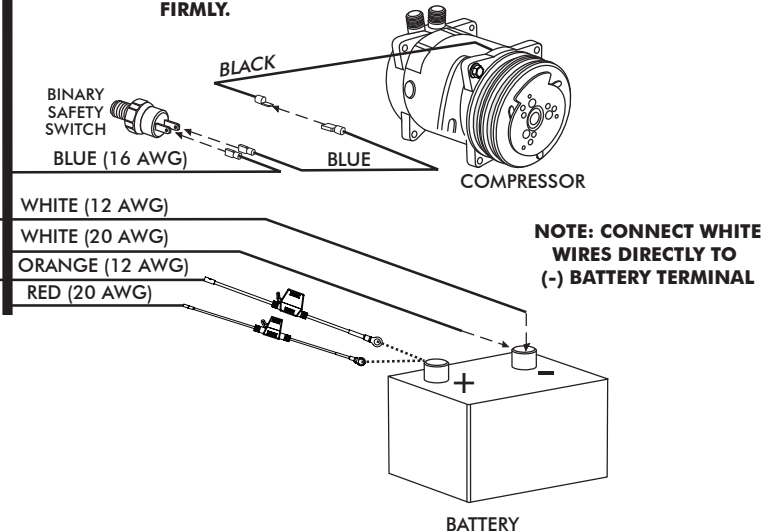
### Heater Control Valve:

Connect the Violet/Yellow/White twisted branch with 3 position connector into the heater control valve connector. Ensure that the mating latch is fully seated.

### Binary/Trinary & Compressor:

**Binary Switch:** Terminate provided insulated female terminal (PN 23172-VUW) to the blue 16 AWG wire. Connect as shown.  
**Trinary Switch:** Connect according to trinary switch wiring diagram.

WIRING HARNESS (232020) →



**NOTE: CONNECT WHITE WIRES DIRECTLY TO (-) BATTERY TERMINAL**

### Battery Connections:

**ECU Ground:** Terminate provided ring terminal (PN 226110) to 20 AWG white wire from the 231505 wire assembly and install at battery.  
**ECU PWR:** Terminate provided fuse assembly with black leads (PN 233012) to the 20 AWG red wire from the 231505 wire assembly. Install provided 5A Brown Mini Fuse (PN 226118). Install at battery.  
**Blower Speed Controller (BSC) Ground:** Terminate provided ring terminal (PN 226111) to 12 AWG white wire from the 232020 wire assembly and install at battery.  
**Blower Speed Controller (BSC) PWR:** Terminate provided fuse assembly with orange leads (PN 233008) to the 12 AWG orange wire from the 232020 wire assembly. Install provided 30A Green ATO/ATC Fuse (PN 226125). Install at battery.



www.vintageair.com

## Operation of Controls

On Gen IV or Gen 5 systems with three lever/knob controls, the temperature control toggles between heat and A/C operations. To activate A/C, move the temperature lever/knob all the way to cold and then back it off to the desired vent temperature. For heat operation, move the temperature lever/knob all the way to hot and then adjust to the desired vent temperature. The blower will momentarily change speed, each time you toggle in and out of heat and A/C operations, to indicate the change. **NOTE: For proper control panel function, refer to the control panel instructions for calibration procedure.**

### Blower Speed

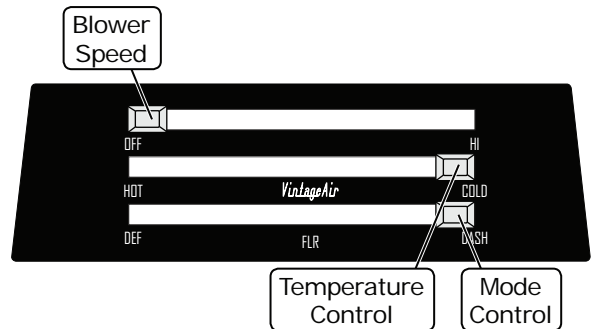
This lever/knob controls blower speed, from OFF to HI.

### Mode Control

This lever/knob controls the mode positions, from DASH to FLOOR to DEFROST, with a blend in between.

### Temperature Control

This lever/knob controls the temperature, from HOT to COLD.



## A/C Operation

### Blower Speed

Adjust to desired speed.

### Mode Control

Adjust to desired mode position (DASH position recommended).

### Temperature Control

For A/C operation, adjust to coldest position to engage compressor (adjust between HOT and COLD to reach desired temperature).



## Heat Operation

### Blower Speed

Adjust to desired speed.

### Mode Control

Adjust to desired mode position (FLOOR position recommended).

### Temperature Control

For maximum heating, adjust to hottest position (adjust between HOT and COLD to reach desired temperature).



## Defrost/De-fog Operation

### Blower Speed

Adjust to desired speed.

### Mode Control

Adjust to DEFROST position for maximum defrost, or between FLOOR and DEFROST positions for a bi-level blend (Compressor is automatically engaged).

### Temperature Control

Adjust to desired temperature.





www.vintageair.com

# Troubleshooting Guide

This printed troubleshooting guide is our basic guide that covers common installation problems. To see our advanced diagnostics and troubleshooting guide, please refer to the following page for instructions on how to download the complete guide.

**WARNING: While troubleshooting the system, never probe connector terminals from the front mating side, only back probe.**

**WARNING: While troubleshooting the system, never use automotive check lights.**

Symptom	Condition	Checks	Actions	Notes
1. Blower stays on high speed with ignition on.	No other functions work.	Check for damaged pins or wires in the control panel wire assembly and mating header at ECU.	If found damaged, replace wire assembly or ECU.	If fuse continues to blow, there is a serious problem in the wiring. Check all wiring and ensure the wire is not damaged and shorting out along its route.
	All other functions work.	Check for a bad ECU GND. Check for damaged pins or wires in the control panel wire assembly and mating header at ECU. Check if Blower power fuse is blown. Check for a bad ECU GND.	If found damaged, replace wire assembly or ECU. Replace fuse. Repair connection.	
2. Compressor will not turn on (All other functions work).	System is not charged.	System must be charged for compressor to engage.	Charge system.	<b>Danger: Never bypass safety switch with engine running. Serious injury can result.</b>
	System is charged.	Check for faulty A/C potentiometer or associated wiring (not applicable to 3-pot controls). Check for disconnected or faulty thermistor.	Check continuity to ground on white control head wire. Check for 5V on red control head wire. Check 2-pin connector at ECU housing.	To check for proper pot function, check voltage at white/red wire. Voltage should be between 0V and 5V, and will vary with pot lever position. Disconnected or faulty thermistor will cause compressor to be disabled.
	Compressor will not turn off (All other functions work).	Check for faulty A/C potentiometer or associated wiring.	Repair or replace pot/control wiring.	Red wire at A/C pot should have approximately 5V with ignition on. White wire will have continuity to chassis ground. White/Red wire should vary between 0V and 5V when lever is moved up or down.
3. Compressor will not turn off (All other functions work).	System is charged.	Check for faulty A/C potentiometer or associated wiring.	Replace relay.	
	System is not charged.	Check for faulty A/C potentiometer or associated wiring.	Replace relay.	





www.vintageair.com

# Troubleshooting Guide (Cont.)

Symptom	Condition	Checks	Actions	Notes
4. System will not turn on, or runs intermittently.	Works when engine is not running; shuts off when engine is started	Noise interference from either ignition or alternator.	Install capacitors on ignition coil and alternator. Ensure good ground at all points. Relocate coil and associated wiring away from ECU and ECU wiring. Check for burned or loose plug wires.	Ignition noise (radiated or conducted) will cause the system to shut down due to high voltage spikes. If this is suspected, check with a quality oscilloscope. Spikes greater than 16V will shut down the ECU. Install a radio capacitor at the positive post of the ignition coil (see radio capacitor installation bulletin). A faulty alternator or worn out battery can also result in this condition.
	Will not turn on under any conditions.	Verify connections on power lead, ignition lead, and both white ground wires. Verify battery voltage is greater than 10 volts and less than 16 while engine is running.	Check for power at ECU, and confirm ignition is being applied to ECU properly. Verify proper meter function by checking the condition of a known good battery.	
5. Loss of mode door function.	No mode change at all.	Check for damaged mode switch or potentiometer and associated wiring.		
	Blower turns on and off rapidly.	Battery voltage is at least 12V. Battery voltage is less than 12V.	Ensure all system grounds and power connections are clean and tight. Charge battery.	System shuts off blower at 10V. Poor connections or weak battery can cause shutdown at up to 11V.
7. Erratic functions of blower, mode, temp, etc.		Check for damaged switch or pot and associated wiring.	Repair or replace.	

## Advanced Diagnostics and Troubleshooting Guide

If after referencing the Troubleshooting Guide, the issue is not resolved, move to The Advanced Diagnostics and Troubleshooting Guide that covers the following:

- ECU Diagnostics Codes
- 1. ECU Blink Sequence
- 2. Firmware Version Number
- 3. ECU Model Number
- 4. ECU Start-Up Blink Sequence
- 5. Diagnostic Codes
- Complete Advanced Troubleshooting Guidelines

Access the latest version of the Advanced Diagnostics and Troubleshooting Guide by scanning the following QR code on your mobile device:



You can also access the guide by typing the following address into your web browser:

[https://www.vintageair.com/instructions\\_pdf/905000.pdf](https://www.vintageair.com/instructions_pdf/905000.pdf)



www.vintageair.com

## Packing List: Evaporator Kit (561244)

No.	Qty.	Part No.	Description
1.	1	765200	Gen 5 Super Magnum Module
2.	1	781244	Accessory Kit

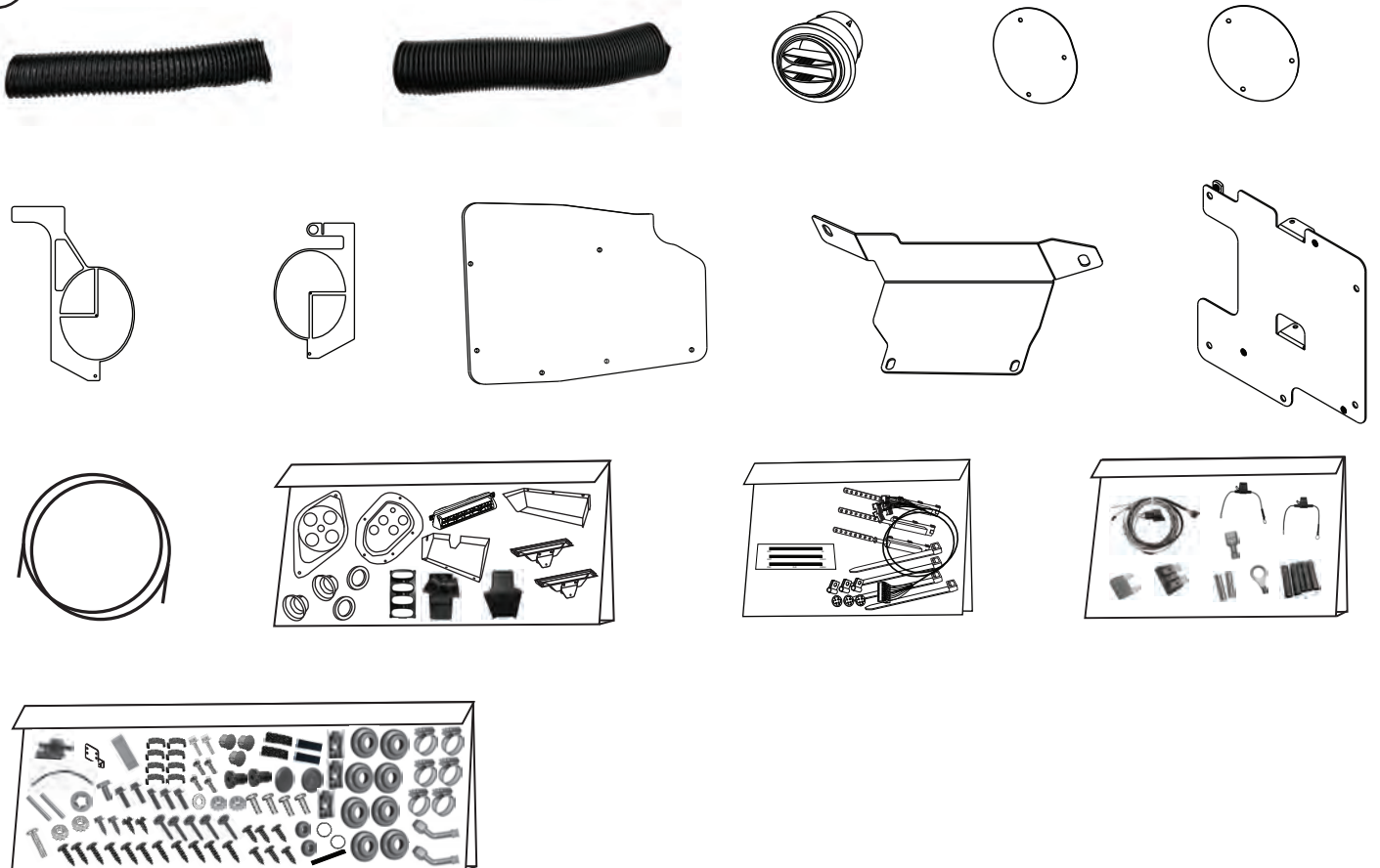
Checked By: \_\_\_\_\_  
Packed By: \_\_\_\_\_  
Date: \_\_\_\_\_

1



Gen 5 Super Magnum  
Module  
765200

2



Accessory Kit  
781244

**NOTE:** Images may not depict actual parts and quantities.  
Refer to packing list for actual parts and quantities.