

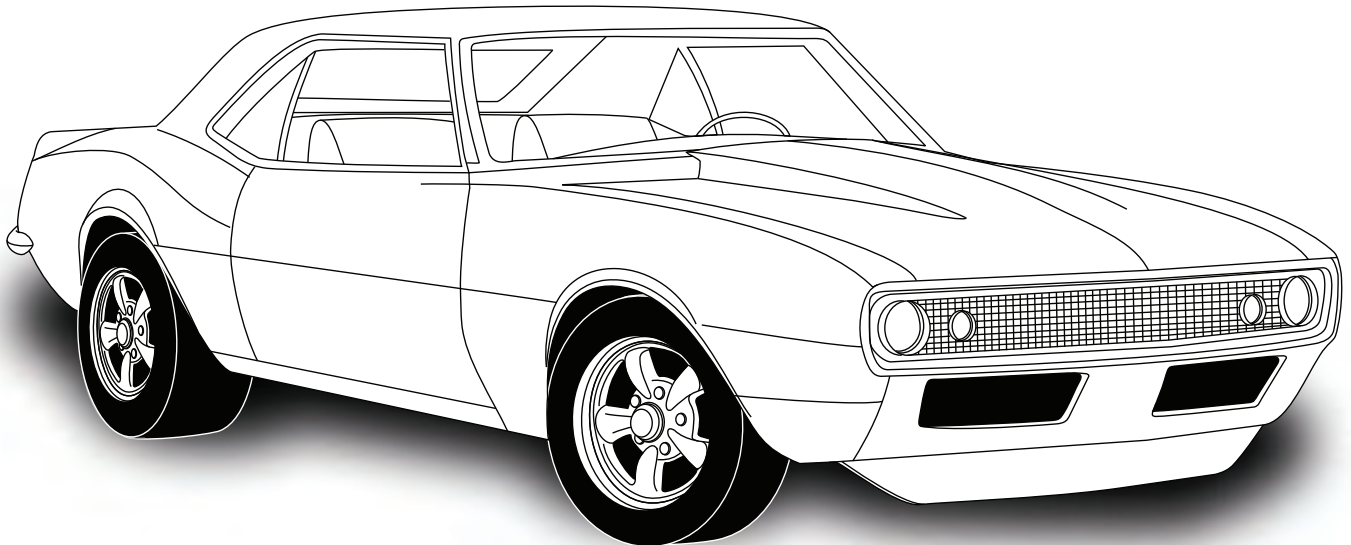

1967-68 Chevrolet Camaro/ Pontiac Firebird

with Factory Air
Gen 5 Evaporator Kit
(564244)



18865 Goll St. San Antonio, TX 78266
Phone: 800-862-6658
Sales: sales@vintageair.com
Tech Support: tech@vintageair.com
www.vintageair.com



www.vintageair.com

Table of Contents

Cover..... 1

Table of Contents..... 2

Packing List/Parts Disclaimer..... 3

Information Page..... 4

Wiring Notice..... 5

Engine Compartment Disassembly..... 6

Condenser Assembly and Installation, Compressor and Brackets, Passenger Compartment Disassembly..... 7-9

Firewall Modification, Defrost Duct & Fresh Air Cover Installation..... 10

Driver- & Passenger-Side OEM Louver Modification, OEM Louver Assembly..... 11

Kick Panel Modification, Firewall Cover Insulation..... 12

Lubricating O-rings, Evaporator Module Preparation..... 13-15

Fresh Air Cap & Kick Panel Cover Preparation, Heater and A/C Hose Installation..... 16-17

Wiring Installation, Kick Panel Installation..... 18

Evaporator Installation..... 19-20

Firewall Cover Installation..... 21

Passenger Compartment Wiring..... 22

ECU, Control Panel & Duct Hose Routing..... 23

Center Louver Installation..... 24

Driver- & Passenger-Side Louver Installation, Control Panel Installation, Fresh Air Cap Installation..... 25

Inner Fender Cover, A/C Hose Installation..... 26

Heater Control Valve Installation..... 27

Quality Crimp Guideline..... 28

Engine Compartment Wiring..... 29-30

Final Steps: Installation Check..... 31

ECU Mounting, Glove Box Installation..... 32

Kick Panel Vent Actuator Cover Installation, Final Steps: Completing the Install..... 33

Gen 5 Wiring Diagram..... 34

Gen 5 Wiring Connection Instruction..... 35

Operation of Controls..... 36

Troubleshooting Guide..... 37

Troubleshooting Guide (Cont.), Advanced Diagnostics and Troubleshooting Guide..... 38

Packing List..... 39



A detailed tech video outlining the installation process of a Gen IV unit is available on Vintage Air's YouTube channel at <http://bit.ly/2GWaxWY>.

Installation processes of Gen IV and Gen 5 units are similar. Viewing the tech video along with the written instructions will provide the installer the most detailed installation procedure.



www.vintageair.com

Packing List: Evaporator Kit (564244)

No.	Qty.	Part No.	Description
1.	1	765200	Gen 5 Super Magnum Module
2.	1	784244	Accessory Kit

**** Before beginning installation, open all packages and check contents of shipment. Please report any shortages directly to Vintage Air within 15 days. After 15 days, Vintage Air will not be responsible for missing or damaged items.**

1



Gen 5 Super Magnum
Module
765200

2

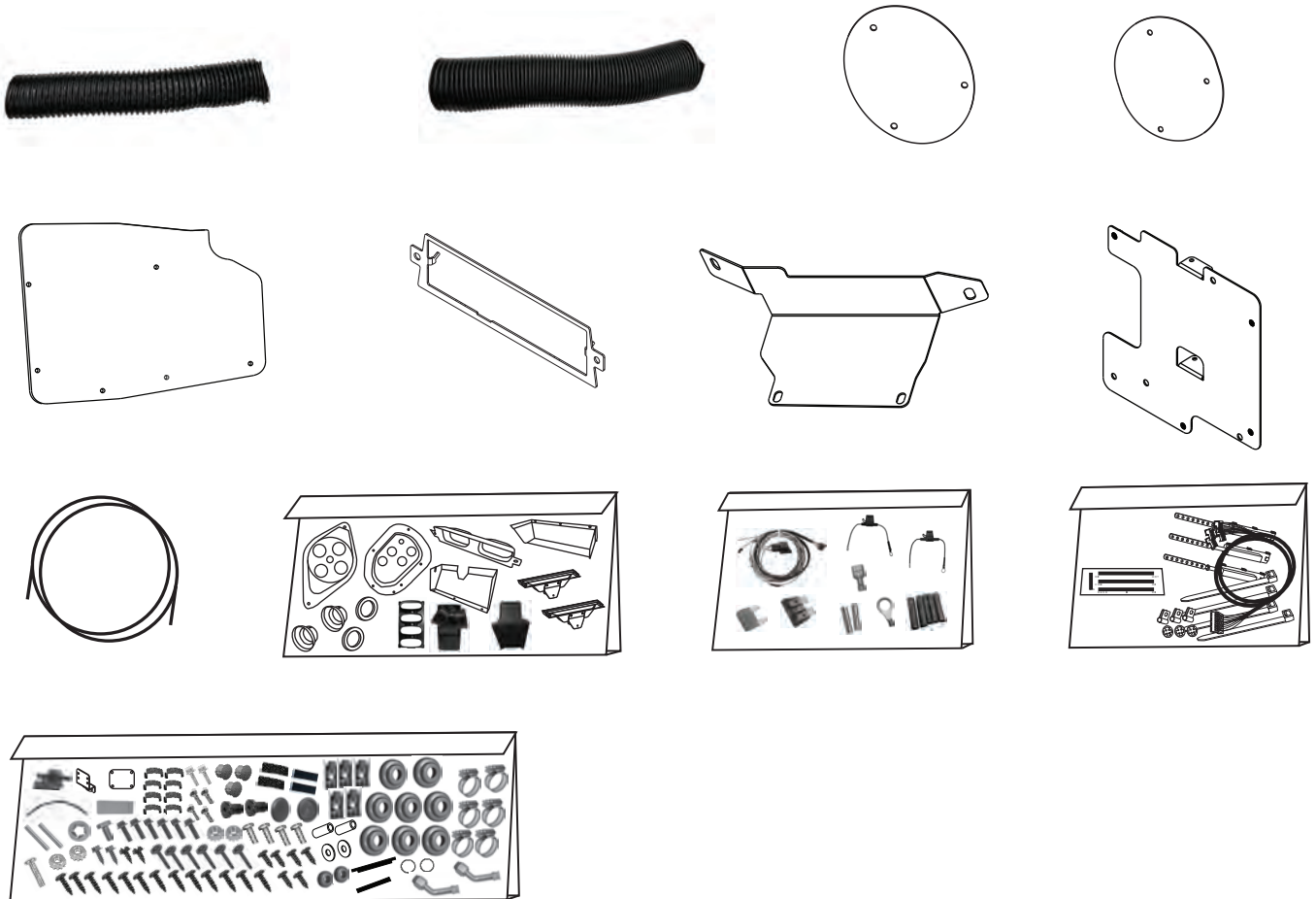

Accessory Kit
784244

NOTE: Images may not depict actual parts and quantities. Refer to packing list for actual parts and quantities.



www.vintageair.com

Important Notice—Please Read

For Maximum System Performance, Vintage Air Recommends the Following:

NOTE: Vintage Air systems are designed to operate with R134a refrigerant only. Use of any other refrigerant could damage your A/C system and/or vehicle, and possibly cause a fire, in addition to potentially voiding the warranties of the A/C system and its components.

Refrigerant Capacities:

Vintage Air System: 1.8 lbs. (28.8 oz.) or 816 grams of **R134a**, charged by weight with a quality charging station or scale. **NOTE: Use of the proper type and amount of refrigerant is critical to system operation and performance.**

Other Systems: Consult manufacturer's guidelines.

Lubricant Capacities:

New Vintage Air-Supplied Sanden Compressor: No additional oil needed (Compressor is shipped with proper oil charge).

All Other Compressors: Consult manufacturer (Some compressors are shipped dry and will need oil added).

Safety Switches

Your Vintage Air system is equipped with a binary pressure safety switch. A binary switch disengages the compressor clutch in cases of extreme low pressure conditions (refrigerant loss) or excessively high head pressure (406 PSI) to prevent compressor damage or hose rupture. A trinary switch combines Hi/Lo pressure protection with an electric fan operation signal at 254 PSI, and should be substituted for use with electric fans. Compressor safety switches are extremely important since an A/C system relies on refrigerant to circulate lubricant.

Service Info:

Protect Your Investment: Prior to assembly, it is critical that the compressor, evaporator, A/C hoses and fittings, hardlines, condenser and receiver/drier remain capped. Removing caps prior to assembly will allow moisture, insects and debris into the components, possibly leading to reduced performance and/or premature failure of your A/C system. This is especially important with the receiver/drier.

Additionally, when caps are removed for assembly, **BE CAREFUL!** Some components are shipped under pressure with dry nitrogen.

Evacuate the System for 35-45 Minutes: Ensure that system components (Drier, compressor, evaporator and condenser) are at a temperature of at least 85°F. On a cool day, the components can be heated with a heat gun **or** by running the engine with the heater on before evacuating. Leak check and charge to specifications.

Bolts Passing Through Cowl and/or Firewall:

To ensure a watertight seal between the passenger compartment and the vehicle exterior, for all bolts passing through the cowl and/or firewall, Vintage Air recommends coating the threads with silicone prior to installation.

Heater Hose (not included with this kit):

Heater hose may be purchased from Vintage Air (Part#31800-VUD) or your local parts retailer. Routing and required length will vary based on installer preference.



www.vintageair.com

Important Wiring Notice—Please Read

Some vehicles may have had some or all of their radio interference capacitors removed. There should be a capacitor found at each of the following locations:

- 1. On the positive terminal of the ignition coil.**
- 2. If there is a generator, on the armature terminal of the generator.**
- 3. If there is a generator, on the battery terminal of the voltage regulator.**

Most alternators have a capacitor installed internally to eliminate what is called “whining” as the engine is revved. If whining is heard in the radio, or just to be extra cautious, a radio interference capacitor can be added to the battery terminal of the alternator.

It is also important that the battery lead is in good shape and that the ground leads are not compromised. There should be a heavy ground from the battery to the engine block, and additional grounds to the body and chassis.

If these precautions are not observed, it is possible for voltage spikes to be present on the battery leads. These spikes come from ignition systems and charging systems, and from switching some of the vehicle’s other systems on and off. Modern computer-operated equipment can be sensitive to voltage spikes on the power leads, which can cause unexpected resets, strange behavior and/or permanent damage.

Vintage Air strives to harden our products against these types of electrical noise, but there is a point where a vehicle’s electrical system can be degraded so much that nothing can help.

Radio interference capacitors should be available at most auto and truck parts suppliers. They typically are cylindrical in shape, a little over an inch long and a little over a half-inch in diameter, and they have a single lead coming from one end of the cylinder with a terminal on the end of the wire, as well as a mounting clip which is screwed into a good ground on the vehicle. The specific value of the capacitance is not too significant in comparison to ignition capacitors that are matched with the coil to reduce pitting of the points.

- Care must be taken, when installing the compressor lead, not to short it to ground. The compressor lead must not be connected to a condenser fan or to any other auxiliary device. Shorting to ground or connecting to a condenser fan or any other auxiliary device may damage wiring or the compressor relay, and/or cause a malfunction.
- When installing ground leads on Gen 5 systems, the blower control ground and ECU ground must be connected directly to the negative battery post.
- For proper system operation, the heater control valve must be connected to the ECU.



www.vintageair.com

Engine Compartment Disassembly

NOTE: Before starting the installation, check the function of the vehicle (horn, lights, etc.) for proper operation, and study the instructions, illustrations, & diagrams.

Perform the Following:

1. Disconnect and remove the battery.
2. Remove the battery tray by removing (4) mounting bolts ((2) bolts on the core support and (2) bolts under the inner fender) (retain).
3. Drain the radiator.
4. Evacuate the A/C system (if necessary).
5. Remove the OEM compressor and compressor bracket (See Photo 1, below).
6. Remove the OEM heater hoses, A/C hoses and hardlines (discard) (See Photos 1 and 2, below).
7. Remove the A/C hoses from the inner fender. Remove the (4) OEM screws and the grommet (See Photo 3, below).
8. Remove the OEM evaporator/blower motor assembly (See Figure 1, below). **NOTE: To remove the evaporator and blower assembly (under hood) and the air distribution system (under dash), the factory manual recommends the following: Remove the right lower rocker molding. Remove the fender attaching bolts. Remove the skirt-to-fender and skirt-to-reinforcement screws. Pull out on the lower portion of the fender, moving the skirt away from the fender flange and firewall. Block the skirt with a 2" x 4" block of wood. To avoid damage to the paint and sheet metal, and for ease of removal and replacement of components, Vintage Air recommends that the right fender be removed, and the inner panel lowered. Removing the right front tire will provide easier access to the inner fender bolts.**
9. Remove the OEM evaporator/blower motor assembly (discard) (See Photo 4, below).
10. Remove the OEM A/C & heater wiring/vacuum harness molded grommet (discard) (See Photo 5, below).
11. Install a 1 5/8" plug into the firewall to cover the OEM firewall hole (See Photo 6, below). **NOTE: A 1 1/2" plug is also provided. Use the plug that best fits the vehicle.**

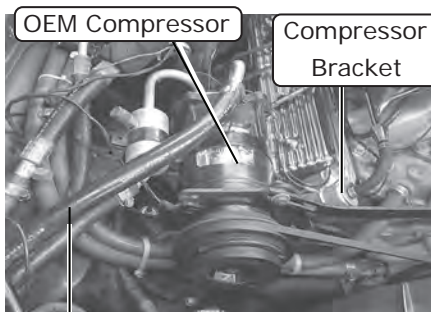

OEM A/C Hoses

Photo 1

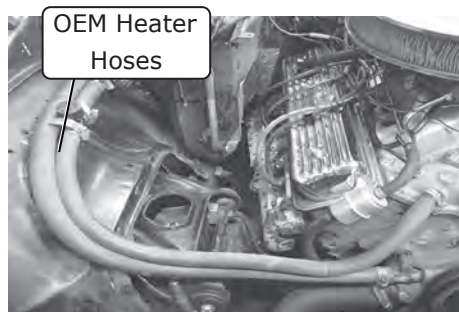
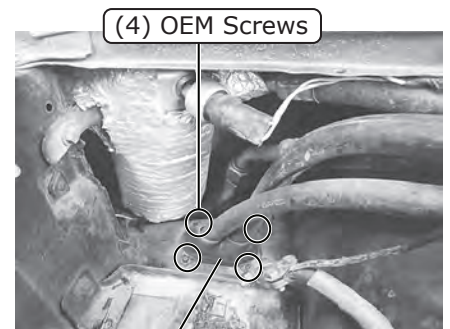

Photo 2



Grommet

Photo 3

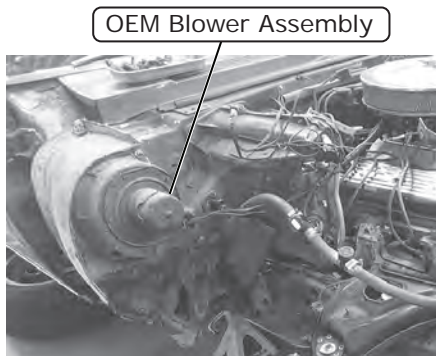

Photo 4

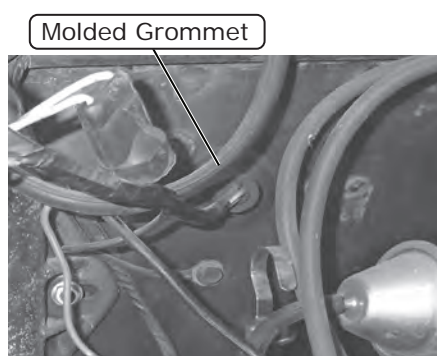

Photo 5

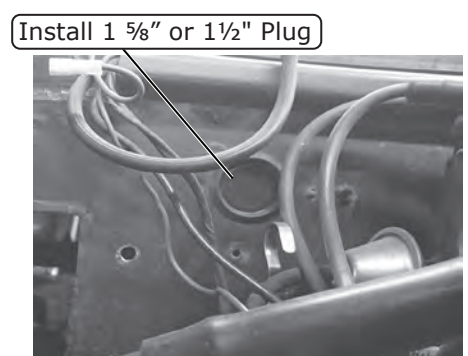

Photo 6



www.vintageair.com

Condenser Assembly and Installation

1. Refer to separate instructions included with the bracket kit to install the compressor bracket.
2. Binary switch installation (Refer to condenser instructions).

Compressor and Brackets

1. Refer to separate instructions included with the bracket kit to install the compressor bracket.

Passenger Compartment Disassembly

NOTE: For ease of installation, Vintage Air recommends removing the front seats.

Perform the Following:

1. On 1968 models equipped with astro ventilation, remove the astro vents and door assemblies (retain astro vents, but discard door assemblies) (See Figure 1, below).
2. Remove the ashtray (retain) (See Photo 1, below).
3. Remove the trim plate and (2) screws (retain) (See Photo 2, below). **NOTE: The center console may have to be loosened to gain access to the trim plate screws. The bottom (2) screws also retain the ashtray slider assembly (See Photo 3, below).**
4. Remove the ashtray slider assembly by removing the screw (retain) (See Photo 3, below).
5. Remove the glove box door by removing (3) screws (retain) (See Photo 4, below).
6. Remove the glove box by removing (4) screws ((2) on top & (2) on the sides) (discard) (See Photo 5, below).
7. Remove the radio by removing the knobs and retaining nuts (retain).

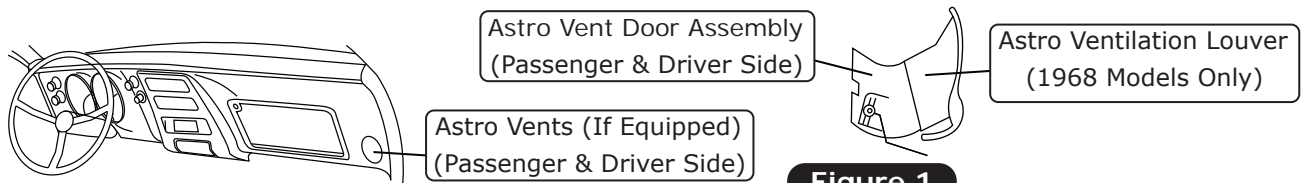

Figure 1



Photo 1

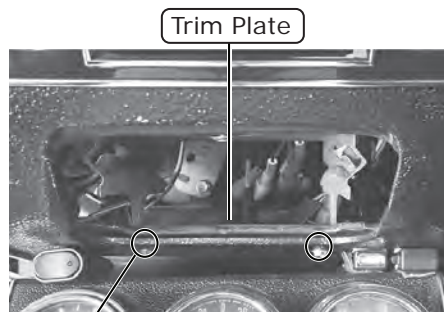

Photo 2

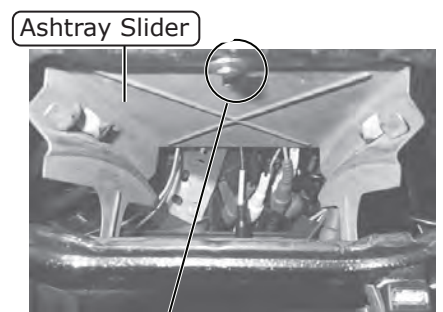

Photo 3



Photo 4



Photo 5



www.vintageair.com

Passenger Compartment Disassembly (Cont.)

8. Remove the radio by removing the knobs and retaining nuts (retain).
9. Disconnect the wiring and antenna cable from the radio (retain).
10. Remove the OEM control panel assembly by removing (4) screws from the dash (retain) and disconnecting the light socket (retain) and cables (discard) (See Photo 6, below).
11. Remove the OEM center louver assembly by removing (2) screws from the dash and disconnecting the hose from the back of the louver housing (retain) (See Photo 7, below).
12. Loosen and lower the steering column by removing the (2) nuts from under the column (retain) (See Photo 8, below).
13. Remove (3) screws from the top of the instrument panel and (4) screws from the bottom of the panel ((2) from the left side and (2) from the right side) (retain) (See Photo 9, below).
14. Disconnect the speedometer cable and wiring plug.
15. Remove the instrument panel (retain).
16. Remove the kick panel vent vacuum actuator cover (retain) by removing (4) screws (See Photo 10, below).
17. Remove the kick panel vent vacuum actuator by removing (2) sheet metal screws. Disconnect the vacuum hose, cable and spring from the vent door (See Photo 11, below).
18. Remove the passenger side kick panel by removing (2) screws (retain) (See Figure 1, below).



Remove (4) screws

OEM Control Panel Assembly

Photo 6

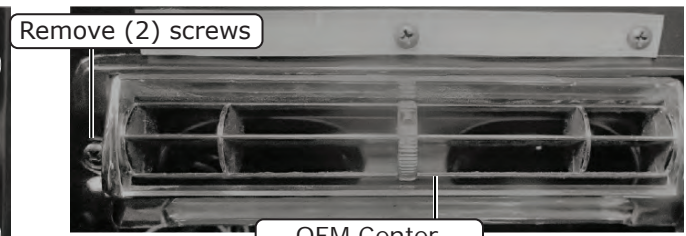

Remove (2) screws

OEM Center Louver Assembly

Photo 7

Remove (2) nuts



Under Steering Column View

Photo 8

Remove (3) screws from top of panel



Remove (2) screws from bottom left

Instrument Panel Assembly

Remove (2) screws from bottom right

Photo 9

Remove (4) nuts

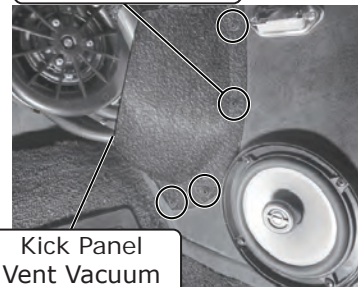

Kick Panel Vent Vacuum Actuator Cover

Photo 10

Disconnect

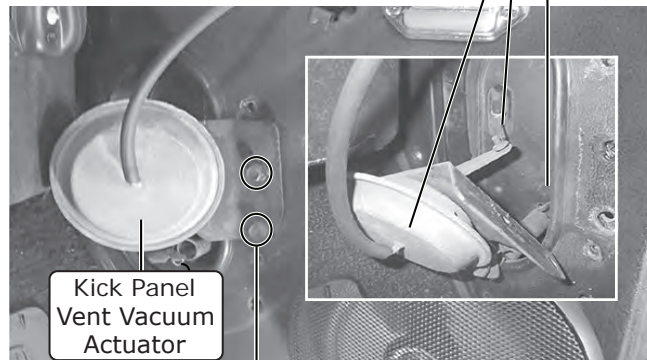

Kick Panel Vent Vacuum Actuator

Remove (2) sheet metal screws

Photo 11

Remove screw

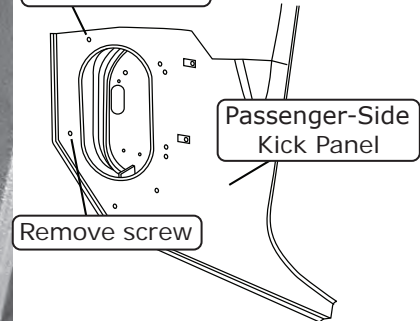

Remove screw

Passenger-Side Kick Panel

Figure 1



www.vintageair.com

Passenger Compartment Disassembly (Final)

19. Remove the OEM defrost duct (discard) (See Figure 2, below).
20. Remove the center louver, and the driver & passenger side louver ducts (discard) (See Figure 3, below).
21. Remove the OEM evaporator (discard) (See Figure 4, below).

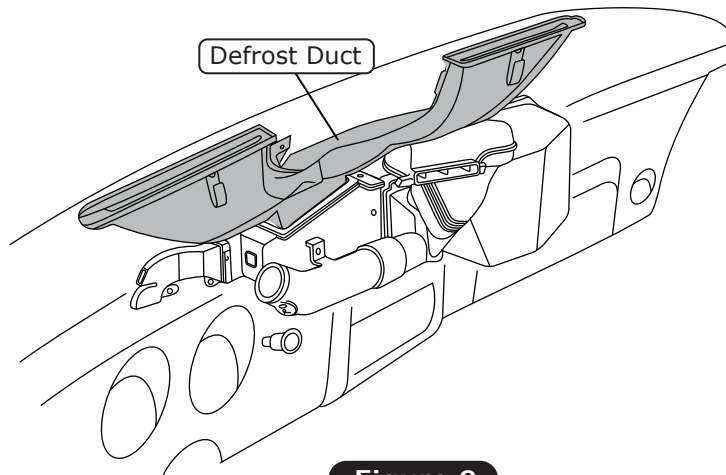

Figure 2

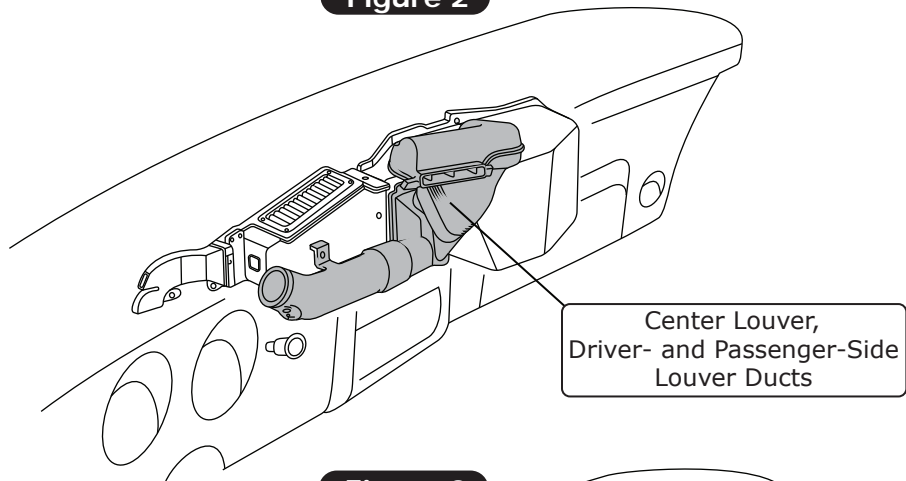

Figure 3

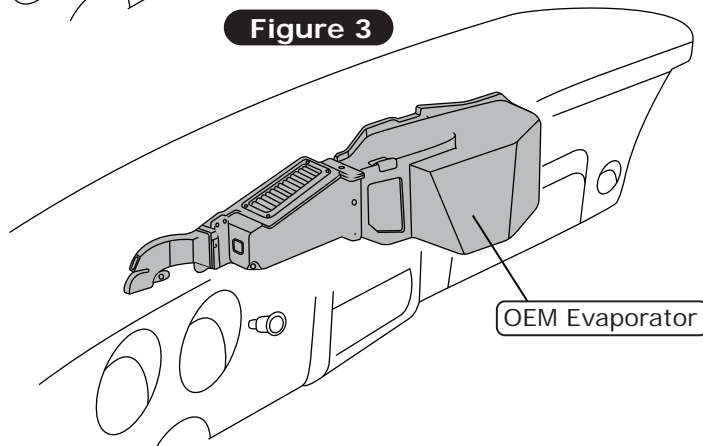

Figure 4



www.vintageair.com

Firewall Modification

NOTE: Firewall modification is required for firewall cover and drain hose installation.

1. Flatten the edges of the firewall opening (See Photo 1, below).
2. Enlarge (6) holes on the firewall to 19/64" as shown in Photo 2, below.
3. From inside the passenger compartment, directly below the lowest OEM hole under the firewall opening, mark and drill a 5/8" hole for the drain hose (See Photo 3, below). **NOTE: To ensure a tight fit, do not enlarge the hole to more than 5/8".**

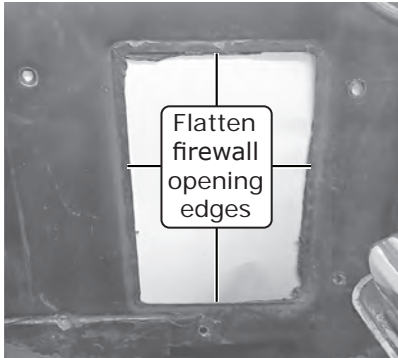

Photo 1

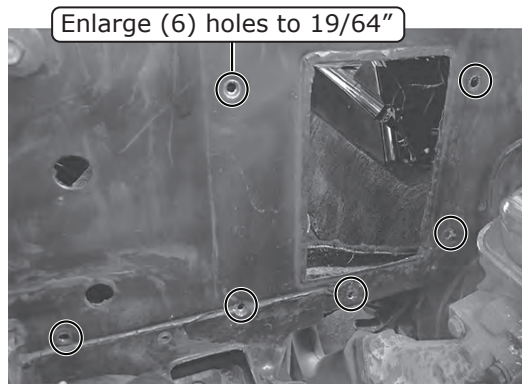

Photo 2

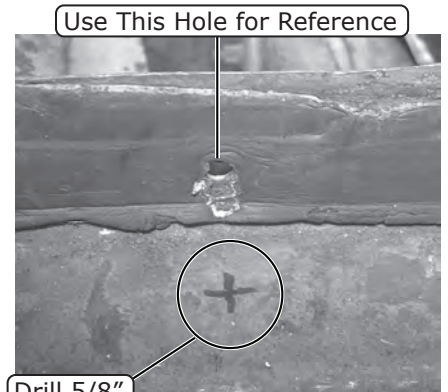

Photo 3

Defrost Duct & Fresh Air Cover Installation

1. Install the defrost ducts under the dash (See Figure 1, below). Align each defrost duct with the defrost opening in the dash, and hold it in place. Using the bracket as a template, drill a 7/64" hole. Secure each defrost duct using a #10 x 1/2" sheet metal screw (See Figure 1, below).
2. If the vehicle is equipped with astro ventilation, apply a 1/4" bead of silicone to the mating surface, and install the driver- and passenger-side fresh air covers using the OEM hardware to secure them (See Figure 1, below).

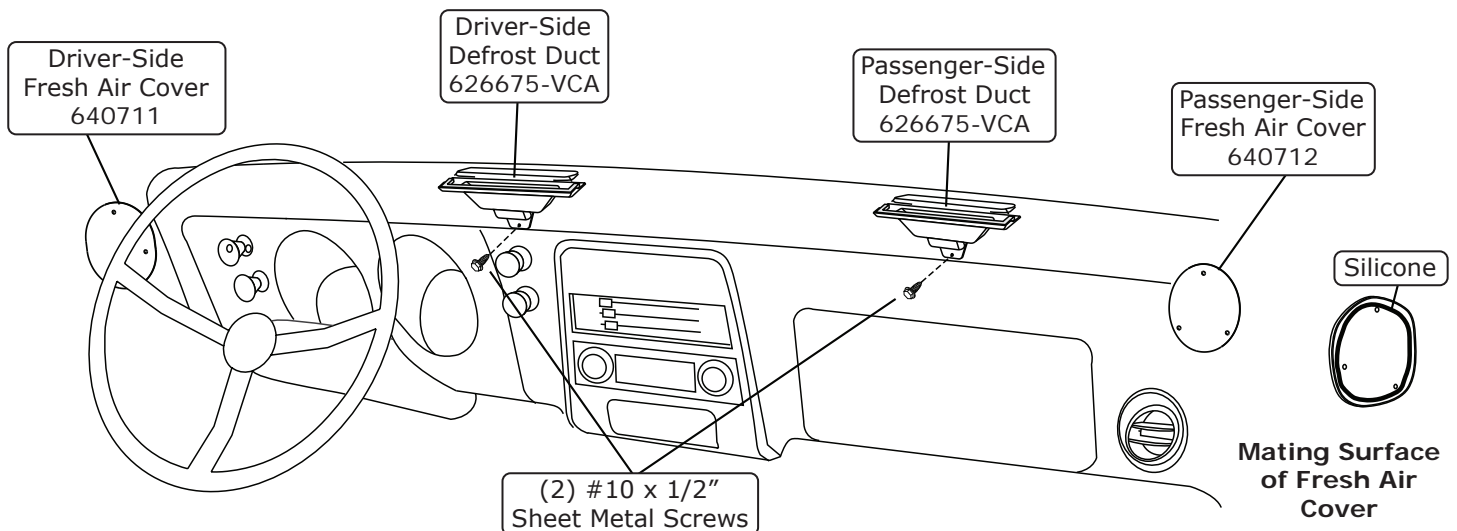

Figure 1



www.vintageair.com

Driver- & Passenger-Side OEM Louver Modification

NOTE: To install the new 2 1/2" hose adapters, it will be necessary to modify the driver- and passenger-side OEM louvers.

1. Disassemble the OEM louver by unclipping the (3) tabs on the louver housing and pulling the assembly apart (See Photo 1, below).
2. Remove the ball louver from the louver housing (See Photo 2, below).
3. Measure and mark 1/4" from the edge of the louver housing (See Photos 3 & 4, below). **NOTE: Repeat the process (2) more times around the louver housing.**
4. Drill (3) 1/8" holes into the louver housing (See Photo 4, below).

Unclip (3) tabs on louver housing

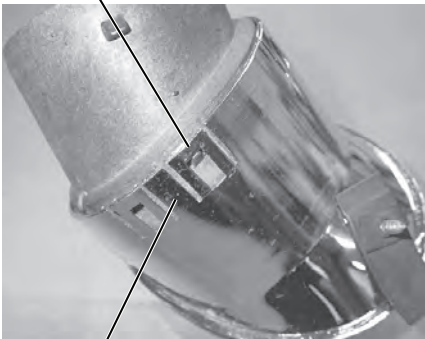

Louver Housing

Photo 1

Remove ball louver from louver housing



Photo 2

Mark and drill (3) 1/8" holes

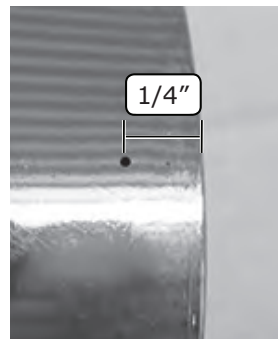
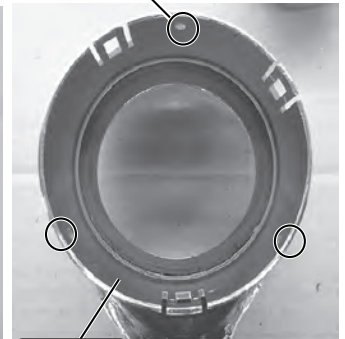

Photo 3



Louver Housing

Photo 4

OEM Louver Assembly

1. On the inner louver housing, adhere a length of the supplied felt strip to the beveled edge. **NOTE: Cut the felt strip to fit as needed (See Photo 1, below).**
2. Insert the OEM ball louver into the OEM louver housing (See Photo 2, below).
3. Install the inner louver hose adapter into the OEM louver housing (See Photo 3, below).
4. Install the outer louver hose adapter flush with the back of the louver housing as shown in Photo 4, below. **NOTE: Before continuing to the next step, ensure that the ball louver can be adjusted if it is too tight or too loose. If adjustment is required, it will need to be completed before the adapter is secured to the housing. If desired, for ease of assembly, (3) small pilot holes (approximately 5/64") can be drilled into the outer ring.**
5. Install (3) #6 x 3/8" pan head screws into the previously drilled holes on the louver housing (See Photo 5, below).

Inner Louver Hose Adapter 49872-VCI

Install Felt Strip 200101



Photo 1

Insert louver ball into housing



Photo 2

Install inner louver hose adapter into housing

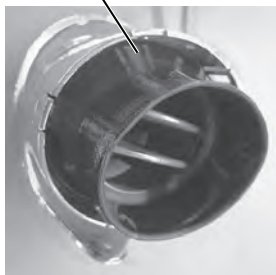

Photo 3

Install outer louver hose adapter into back of housing

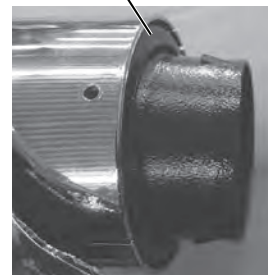

Photo 4

Install (3) #6 x 3/8" pan head screws into drilled holes

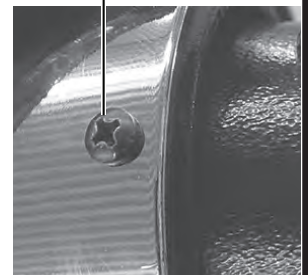

Photo 5



www.vintageair.com

Kick Panel Modification

1. Remove the fresh air door assembly from the OEM kick panel by lifting up on the door toward the spring and sliding it out of the hinge housing (See Photo 1, below).
2. Trim the fresh air door housing to make it flush with the back of the kick panel (See Photos 2 & 3, below).

Lift Door Toward Spring to Remove



Photo 1

Fresh Air Door Housing

Trim Housing

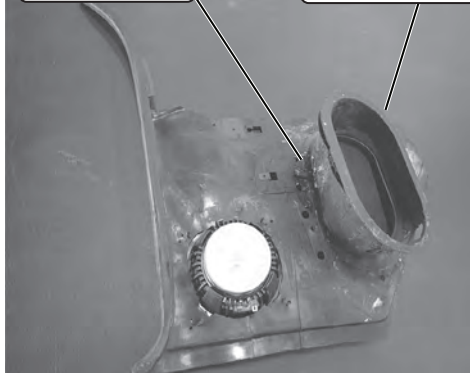

Before Modification

Photo 2

Trim Flush with Kick Panel Housing

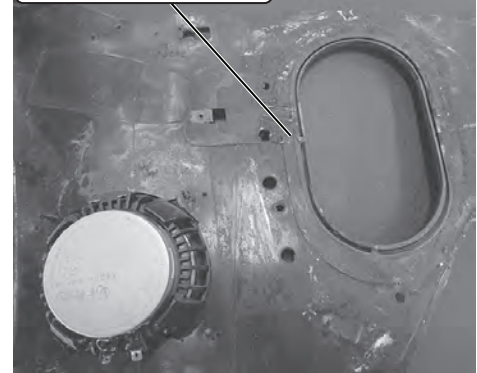

After Modification

Photo 3

Firewall Cover Insulation

NOTE: For proper system operation, Vintage Air recommends using heat blocking insulation in the area around the evaporator unit (firewall, kick panel, inner cowl, firewall covers). Due to tight clearance for the evaporator unit between the firewall and dash, Vintage Air recommends an insulation thickness of no more than 1/4".

1. To apply insulation to the firewall cover, temporarily install the firewall cover onto the firewall using (2) 1/4-20 x 3/4" bolts and (2) 1/4-20 nuts with star washers (See Photo 1, below).
2. From the passenger compartment, trace the firewall opening onto the firewall cover (See Photo 2, below).
3. Remove the firewall cover, and apply insulation to the traced area (See Photo 3, below).

Temporarily Install Firewall Cover with (2) 1/4-20 x 3/4" Bolts & (2) 1/4-20 Nuts with Star Washers

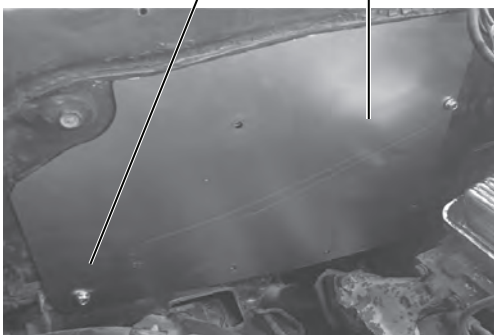

Engine Compartment View

Firewall Cover 640684

Trace Firewall Opening

Firewall Cover 640684

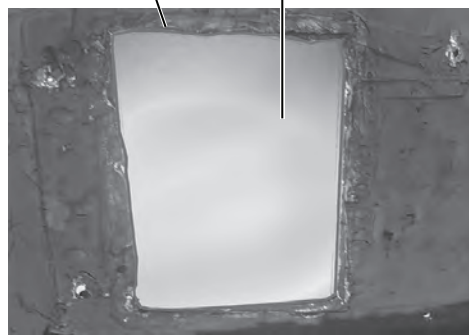

Passenger Compartment View

Apply Insulation to Traced Area

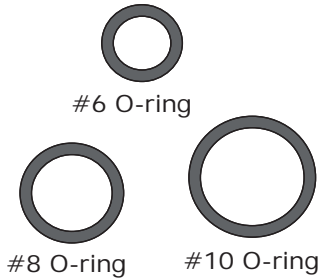

Photo 3



www.vintageair.com

Lubricating O-rings



NOTE: Standard torque specifications:
#6: 11 to 13 ft-lb.
#8: 15 to 20 ft-lb.
#10: 21 to 27 ft-lb.

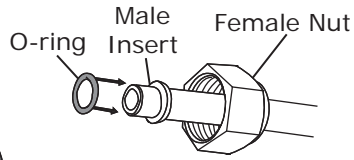

For a proper seal of fittings: Install supplied O-rings as shown and lubricate with supplied oil.

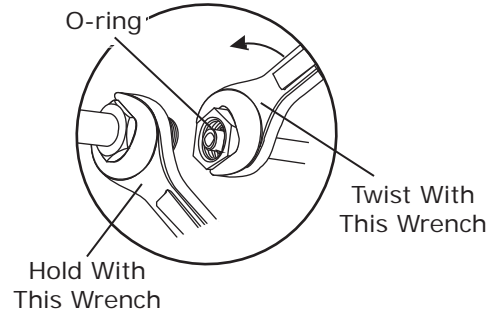
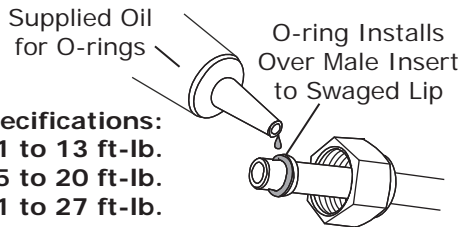

Evaporator Module Preparation

Perform the following on a workbench:

1. Install (3) 1/2" plastic plugs into the back of the evaporator module (See Photos 1, 2, 3 and 4, below).

Install 1/2" plastic plug into back of evaporator unit

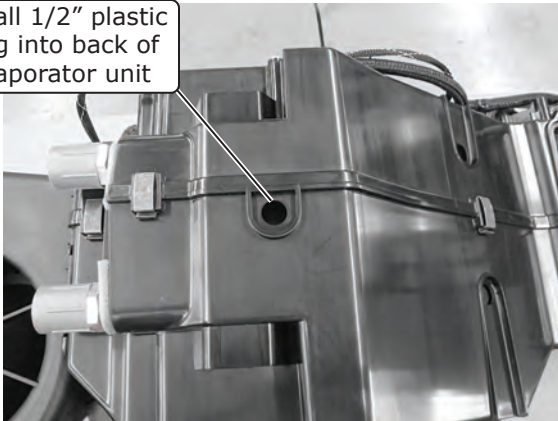

Photo 1

1/2" plastic plug

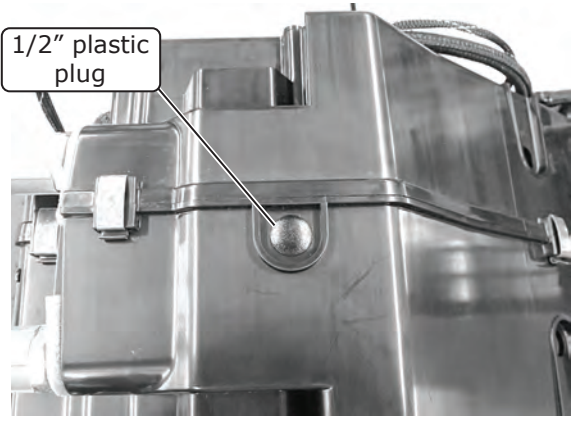

Photo 2

Install (2) 1/2" plastic plugs

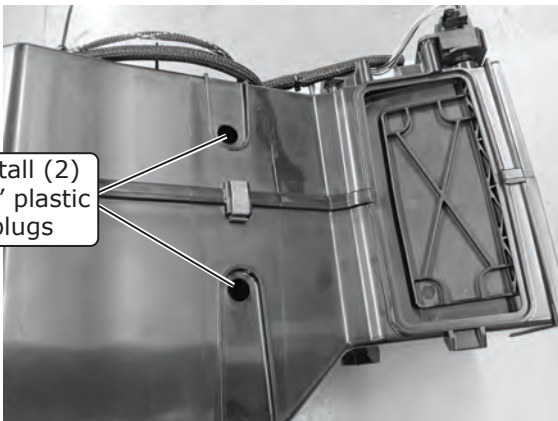

Photo 3

(2) 1/2" plastic plugs

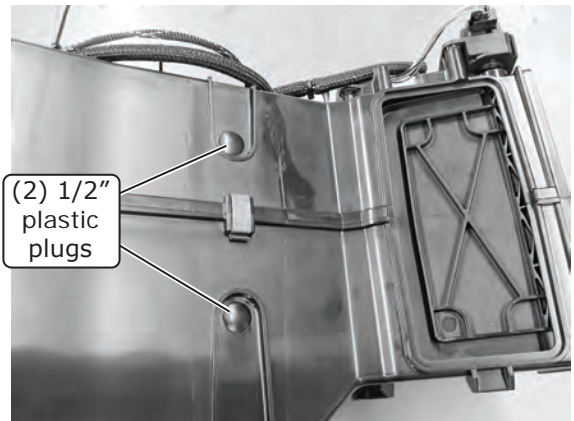

Photo 4



www.vintageair.com

Evaporator Module Preparation (Cont.)

2. Install the upper heater hardline onto the evaporator module using a properly lubricated #10 O-ring (See Lubricating O-rings, Page 13 and Photo 5, below). **NOTE: Install hardline facing downward.**
3. Install the lower heater hardline onto the evaporator module using a properly lubricated #10 O-ring (See Lubricating O-rings, Page 13 and Photo 6, below). **NOTE: Install hardline facing downward.**
4. Install the evaporator firewall bracket onto the module and secure it using (4) #10 x 5/8" screws (See Photos 7, 8 and 9, below).
5. Install (2) 1/4-20 x 1 1/2" full-threaded studs into the (2) upper mounting holes on the evaporator firewall bracket (See Photo 10, below). **NOTE: Thread the studs in a 1/4" of the way.**

Install upper heater hardline onto evaporator module with properly lubricated #10 O-ring

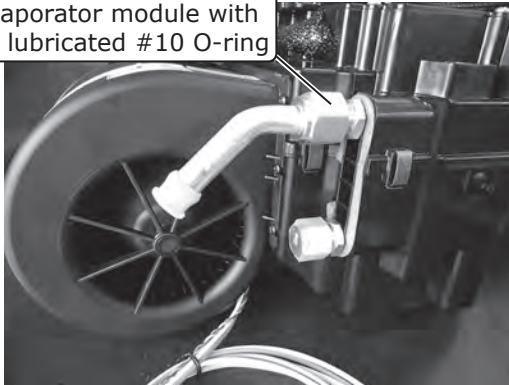
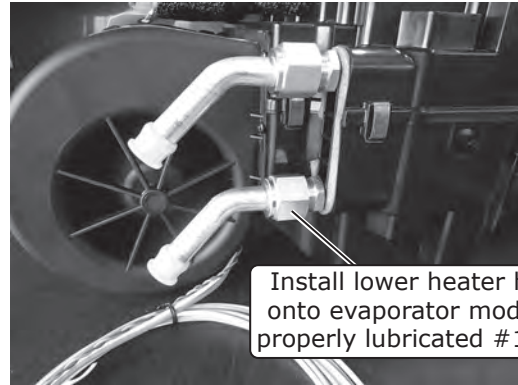

Photo 5



Install lower heater hardline onto evaporator module with properly lubricated #10 O-ring

Photo 6

Install evaporator firewall bracket (640708) onto evaporator module

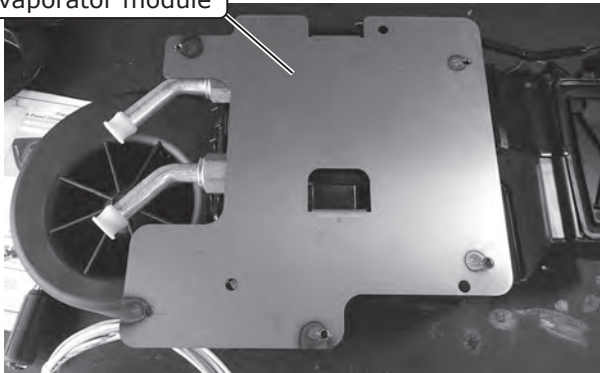

Photo 7

Secure bracket to module using (2) #10 x 5/8" screws



Bottom of Module View

Photo 8

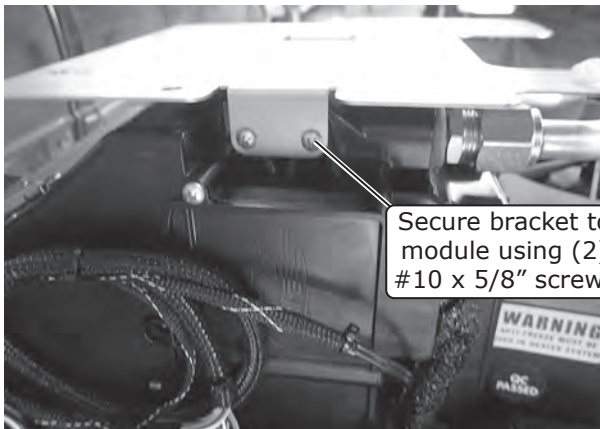

Top of Module View

Secure bracket to module using (2) #10 x 5/8" screws

Photo 9

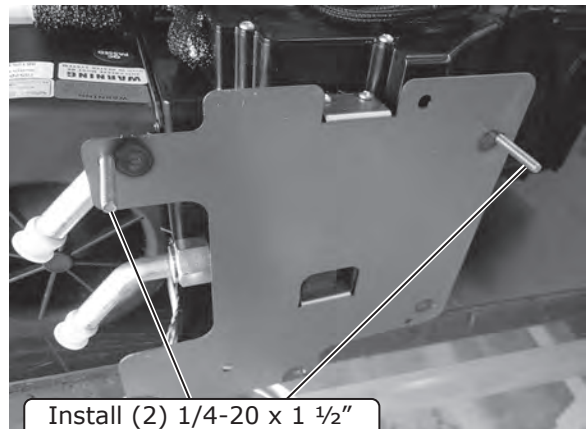

Install (2) 1/4-20 x 1 1/2" full-threaded studs into bracket a 1/4" of the way in

Photo 10



www.vintageair.com

Evaporator Module Preparation (Final)

- Using (4) spring clips, install the dash plenum onto the evaporator module (See Photo 11, below).
- Using (2) spring clips, install the floor plenum onto the back of the evaporator module (See Photo 12, below).
- Using (2) spring clips, install the defrost plenum onto the front of the evaporator module (See Photo 13, below).
- Loosen the (2) screws securing the ECU (See Photo 14, below), then remove it and let it hang in front of the module. Retighten the mounting screws.

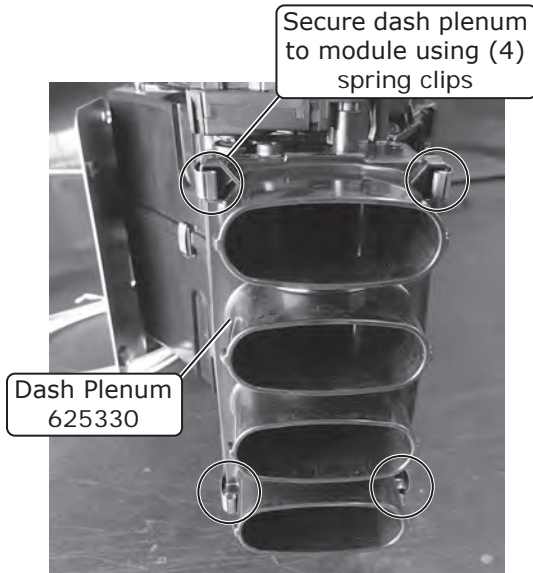

Photo 11

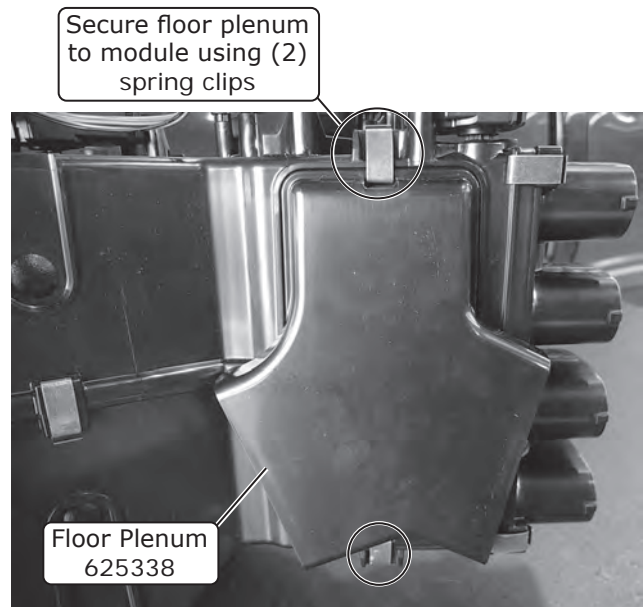

Photo 12

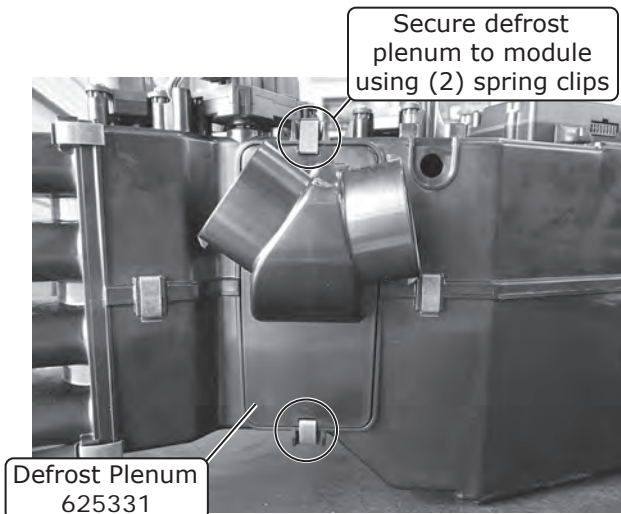

Photo 13



Photo 14



www.vintageair.com

Fresh Air Cap & Kick Panel Cover Preparation

1. Install (3) large, (1) 1 1/4" O.D. and (1) 7/8" O.D. grommets into the fresh air cap (See Photos 1 & 2, below).
2. Install (3) large, (1) 1 1/4" O.D. and (1) 7/8" O.D. grommets into the kick panel cover (See Photos 3 & 4, below).

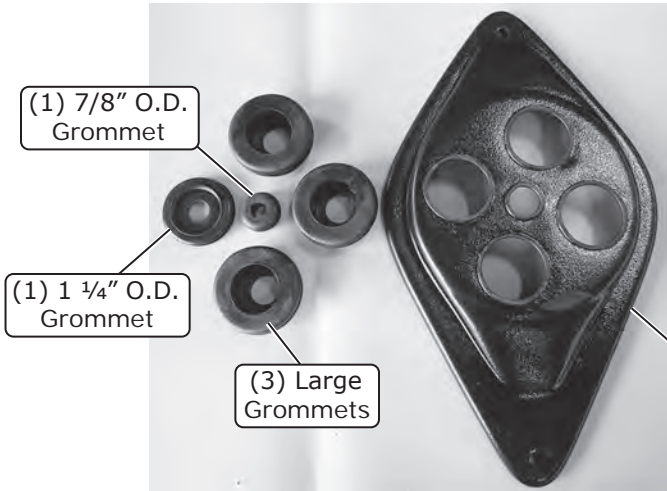

Photo 1

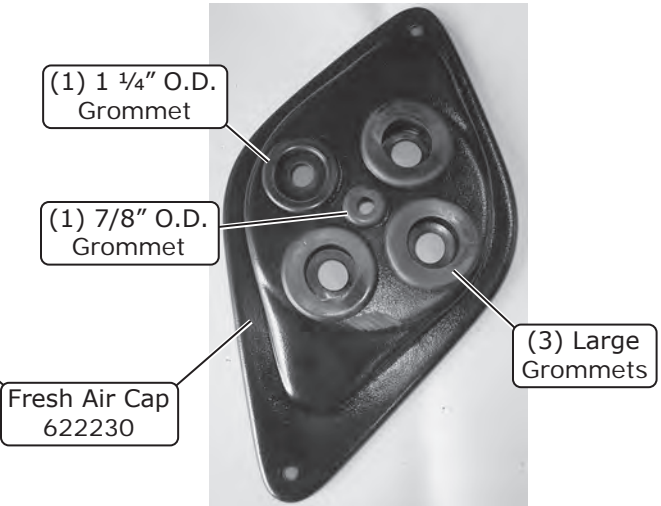

Photo 2

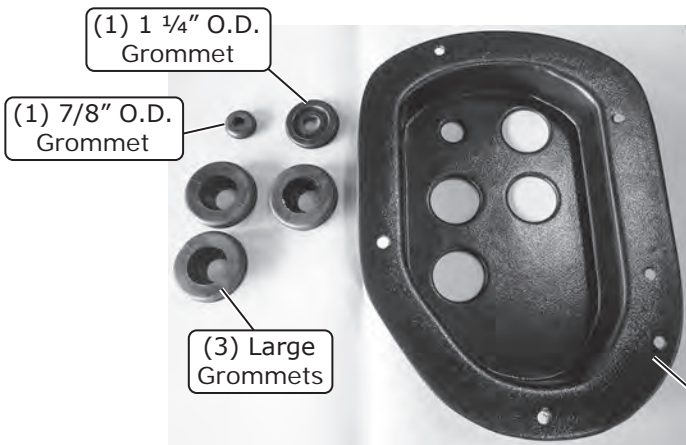

Photo 3

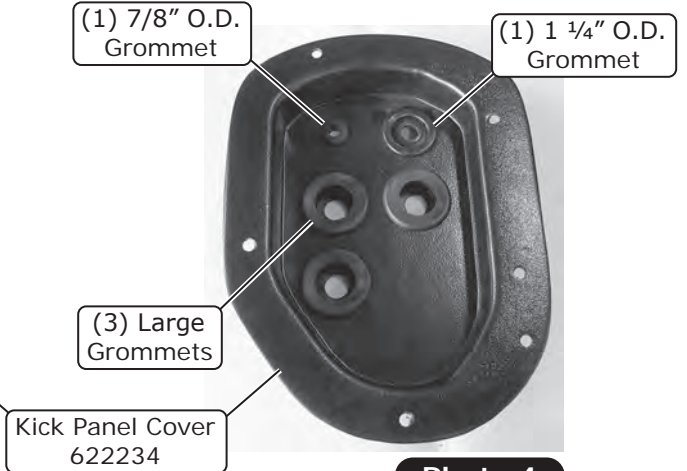

Photo 4

Heater and A/C Hose Installation

NOTE: Soapy water may be used to ease insertion of A/C and heater hoses through the grommets, but be sure the hoses are capped to prevent water from getting inside.

1. On the inside of the fresh air cap, the letter "T" indicates the top mounting hole for the firewall (See Photo 1, below).

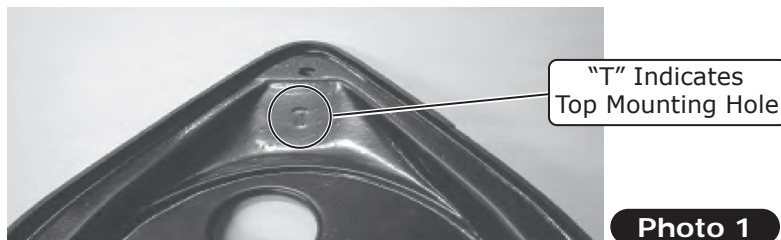

Photo 1



www.vintageair.com

Heater and A/C Hose Installation (Cont.)

2. Insert a length of heater hose through the bottom-right large grommet on the fresh air cap (See Photo 2, below).
3. Insert a length of heater hose through the top-right large grommet on the fresh air cap (See Photo 3, below).
4. Insert the 45° fitting on the #10 compressor/evaporator A/C hose through the bottom-left large grommet on the fresh air cap (See Photo 4, below). **NOTE: Temporarily remove the large grommet from the fresh air cap to ease insertion of the #10 hose fitting.**
5. Insert the 45° fitting on the #6 drier/evaporator A/C hose through the top-left 1 1/4" O.D. grommet on the fresh air cap (See Photo 5, below).
6. From the passenger compartment, insert the lower heater hose through the bottom-left large grommet on the kick panel cover (See Photo 6, below).
7. Insert the upper heater hose through the top-left large grommet on the kick panel cover (See Photo 7, below).
8. Insert the #10 compressor/evaporator A/C hose through the bottom-right grommet on the kick panel cover (See Photo 8, below). **NOTE: Temporarily remove the grommet from the kick panel cover for easier insertion.**
9. Insert the #6 drier/evaporator A/C hose through the top-right large grommet on the kick panel cover (See Photo 9, below).

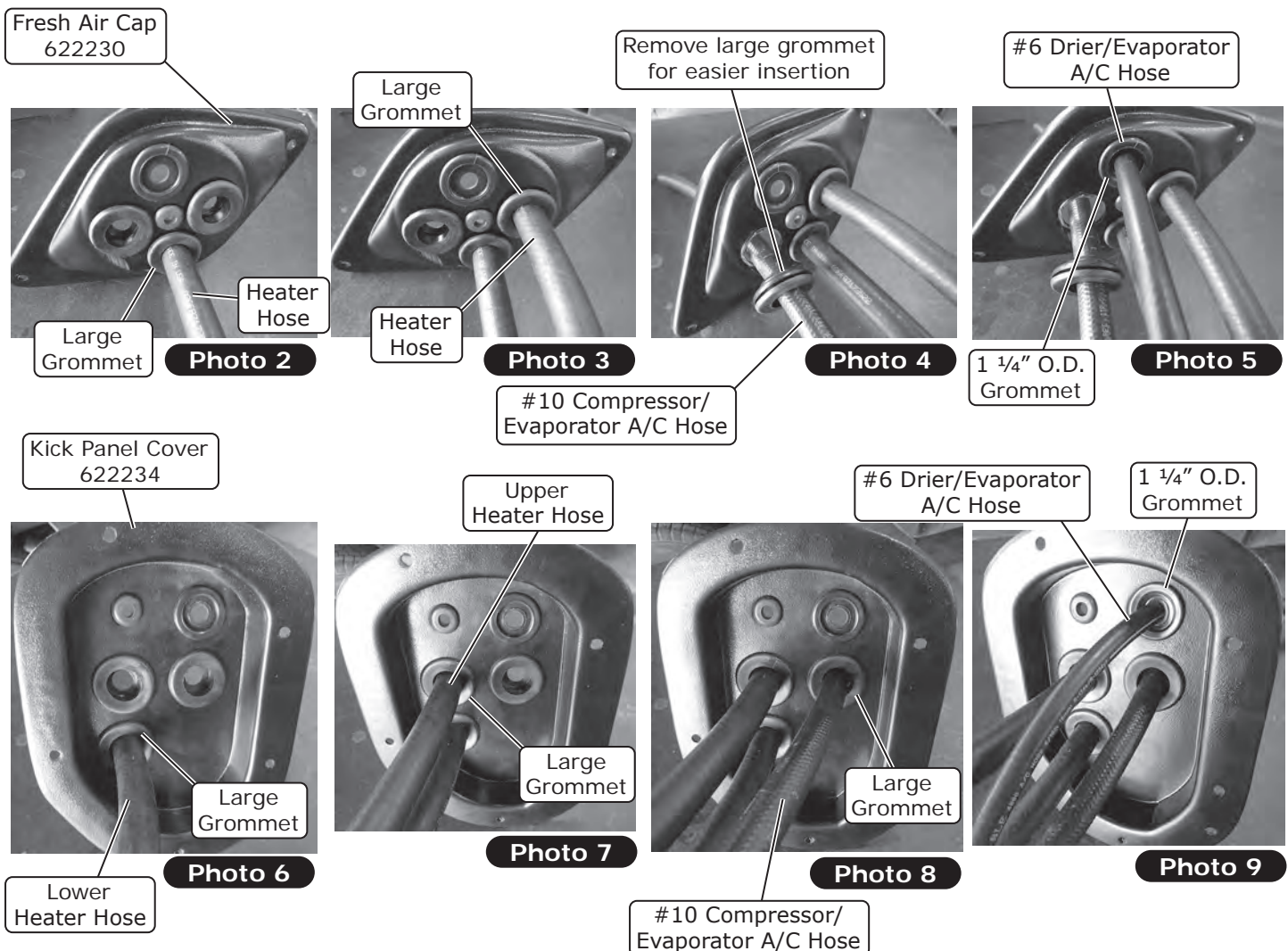



www.vintageair.com

Wiring Installation

1. From the passenger compartment, route the heater control valve connector and wiring (red, white and blue), and the red, white and blue wires from the main wiring harness through the 7/8" O.D. grommet on the kick panel cover and into the 7/8" O.D. grommet on the fresh air cap (See Photo 1, below). **NOTE: Leave approximately 5" of wiring between the relay and the kick panel cover. This is to allow enough wiring to secure the relay to the mounting position.**
2. Place the evaporator module on the passenger-side floorboard and route the orange and white wires through the 7/8" O.D. grommet on the kick panel cover, then through the 7/8" O.D. grommet on the fresh air cap.

Route heater control valve connector and wiring (white, yellow and purple), and red, white and blue wires from main wiring harness through 7/8" O.D. grommet on kick panel cover and into 7/8" O.D. grommet on fresh air cap

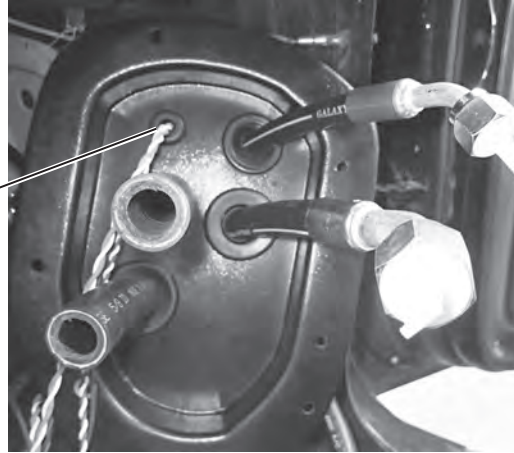

NOTE: Leave approximately 5" of wiring between relay and kick panel cover to allow enough wiring to secure relay to mounting position.

Photo 1

Kick Panel Installation

1. Apply a bead of silicone around the mating surface of the kick panel cover (See Figure 1, below).
2. Install the kick panel cover into place, lining up the mounting holes on the cover with the OEM mounting holes on the kick panel opening.
3. Install the kick panel, routing the hoses and wiring through the opening. Secure the panel using (4) #8 x 1 1/4" countersunk screws with washers (See Photo 1, below). **NOTE: Use only the mounting holes shown in Photo 1, below, at this time.**
4. Using a #8 x 1 1/4" countersunk screw, secure the relay to the upper OEM kick panel mounting hole as shown in Photo 2, below.

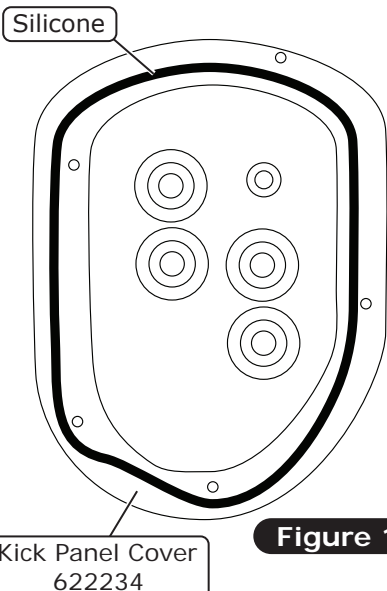
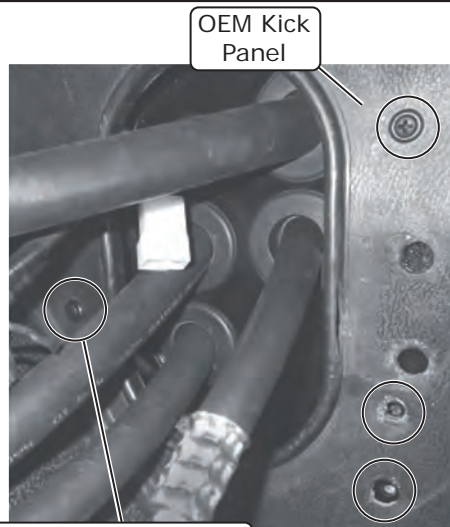
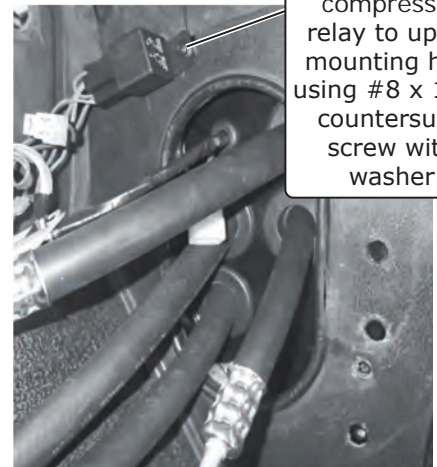

Figure 1



(4) #8 x 1 1/4" Countersunk Screws with Washers

Photo 1



Secure compressor relay to upper mounting hole using #8 x 1 1/4" countersunk screw with washer

Photo 2



www.vintageair.com

Evaporator Installation

NOTE: A 10" block of wood may be used to support the evaporator unit while the following steps are completed. To ensure a watertight seal between the passenger compartment and the vehicle exterior, for all bolts passing through the firewall, Vintage Air recommends coating the threads with silicone prior to installation.

1. Install the upper heater hose and a hose clamp onto the upper heater hardline on the evaporator module (See Photo 1, below).
2. Install the lower heater hose and a hose clamp onto the lower heater hardline on the evaporator module (See Photo 2, below).
3. Roll the evaporator into it's mounting position. Insert the (2) 1/4-20 x 1 1/2" full-threaded studs into the upper OEM mounting holes on the firewall (See Photo 3, below).
4. Using a properly lubricated #6 O-ring (See Lubricating O-rings, Page 13), install the 45° fitting on the #6 drier/evaporator A/C hose onto the block-valve adapter on the evaporator module (See Photo 4, below).
5. Using a properly lubricated #10 O-ring (See Lubricating O-rings, Page 13), install the 45° fitting on the #10 compressor/evaporator A/C hose onto the #10 fitting on the block-valve adapter on the evaporator module (See Photo 5, below). **NOTE: After installing the #10 compressor/evaporator A/C hose, wrap all exposed metal with the supplied press tape (See Photo 6, below).**

Install upper heater hose onto upper heater hardline

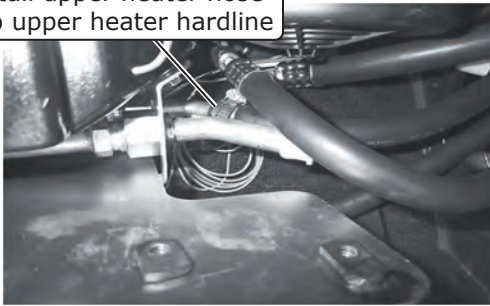

Photo 1

Install lower heater hose onto lower heater hardline

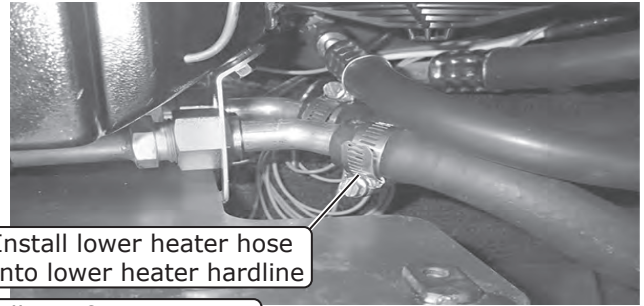

Photo 2

Install 45° fitting on #6 drier/evaporator A/C hose onto block-valve adapter

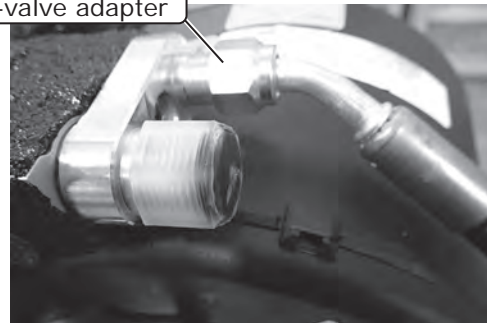

Photo 4

Insert (2) 1/4-20 x 1 1/2" full-threaded studs into upper OEM mounting holes on firewall

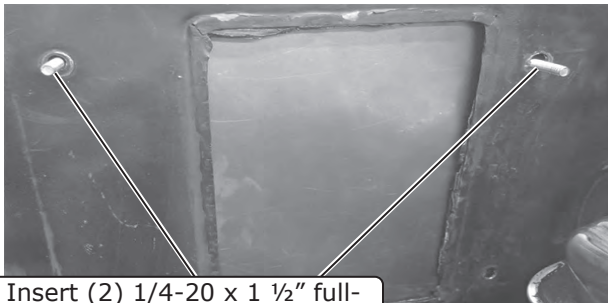

Photo 3

Install 45° fitting on #10 compressor/evaporator A/C hose onto block-valve adapter

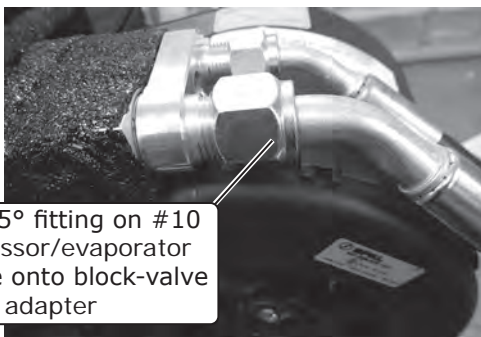

Photo 5

Wrap all exposed metal with supplied press tape

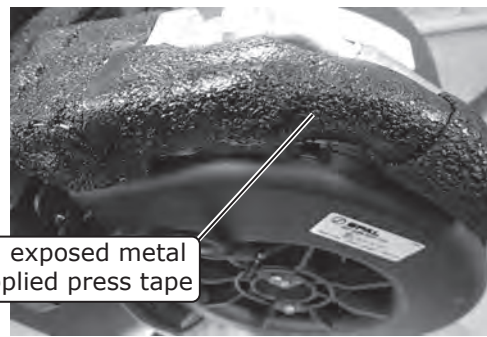

Photo 6



www.vintageair.com

Evaporator Installation (Cont.)

6. Install (2) 1/4-20 well nuts onto the evaporator module (See Photo 7, below).
7. Install (2) #8 U-nuts onto the evaporator dash bracket (See Photo 8, below).
8. Position the evaporator dash bracket under the glove box door mounting holes, then secure it onto the evaporator unit using (2) 1/4-20 x 1" serrated flange bolts (See Photo 9, below).

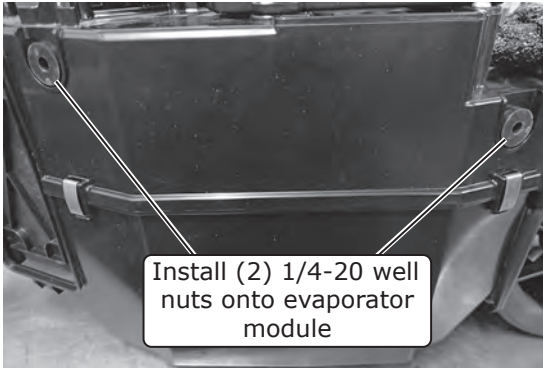
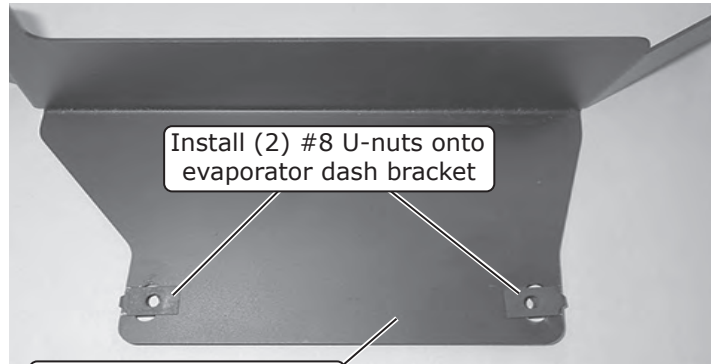

Photo 7



Evaporator Dash Bracket
640710

Photo 8

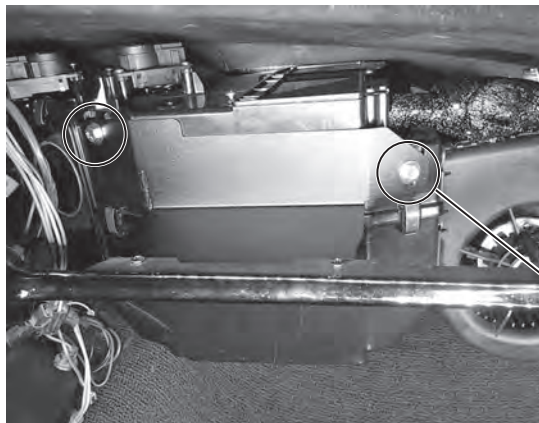

Photo 9

Drain Hose Installation

1. Install the drain hose through the previously drilled 5/8" hole in the firewall. Attach the drain hose onto the drain outlet on the bottom of the evaporator module (See Photo 1, below).



Photo 1



www.vintageair.com

Firewall Cover Installation

NOTE: To ensure a watertight seal between the passenger compartment and the exterior, for all bolts passing through the firewall, Vintage Air recommends coating the threads with silicone prior to installation.

1. Locate the bottom-left mounting hole on the firewall cover, and install a 1/4-20 x 3/4" bolt and a 1/4" pushnut retainer (See Photo 1, below).
2. Apply a bead of silicone around the mating surface of the firewall cover as shown in Photo 2, below.
3. Install the firewall cover onto the (2) 1/4-20 x 1 1/2" full-threaded studs, then secure it using (2) 1/4-20 nuts with star washers (See Photo 3, below).
4. Install (3) 1/4-20 x 3/4" black serrated flange bolts into the remaining open mounting holes on the firewall cover and into the evaporator firewall bracket (See Photo 4, below). **NOTE: Do not tighten at this time.**
5. Remove the (2) 1/4-20 nuts with star washers and (2) 1/4-20 x 1 1/2" full-threaded studs from the firewall cover, and replace them with (2) 1/4-20 x 3/4" black serrated flange bolts (See Photo 5, below).
6. Install (1) of the previously removed 1/4-20 nuts with star washers onto the bottom-right firewall cover bolt in the passenger compartment (See Photo 6, below).
7. Verify the evaporator unit is level and square to the dash. **NOTE: To ensure proper drainage, it is very important that the evaporator is level, both left-right and fore-aft. Check for level on the flat portions of the case around the drain.**
8. Tighten all of the mounting bolts at this time. **NOTE: Tighten the bolts on the firewall first. Adjust the evaporator dash bracket as needed, then tighten the bolts on the evaporator unit. Silicone or seam sealer may be applied around the outer edge of the firewall cover.**

Install a 1/4-20 x 3/4" black serrated flange bolt

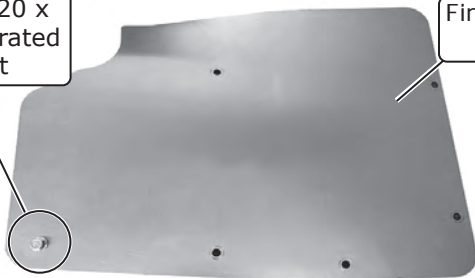

Engine Compartment Side View

Photo 1

Firewall Cover 640684

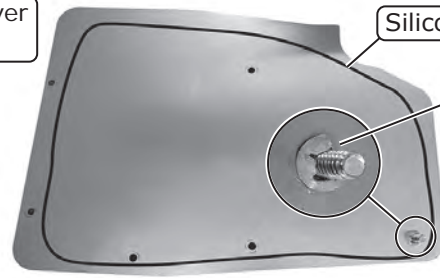

Passenger Compartment Side View

Photo 2

Silicone

1/4" Pushnut Bolt Retainer

Install firewall cover onto the (2) 1/4-20 x 1 1/2" full-threaded studs

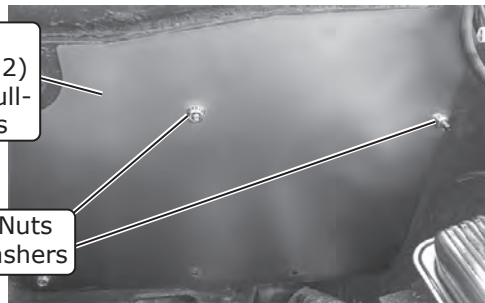

Engine Compartment View

Photo 3

(2) 1/4-20 Nuts with Star Washers



Install (3) 1/4-20 x 3/4" black serrated flange bolts

Photo 4

Remove (2) 1/4-20 nuts with star washers and (2) 1/4-20 x 1 1/2" full-threaded studs, then replace with (2) 1/4-20 x 3/4" black serrated flange bolts

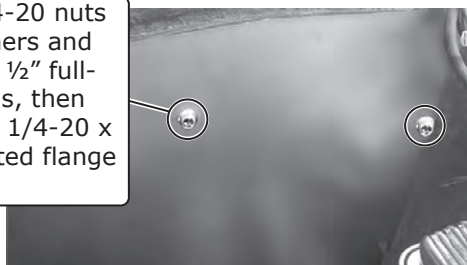

Engine Compartment View

Photo 5

Install a 1/4-20 nut with star washer onto bottom-right firewall cover bolt

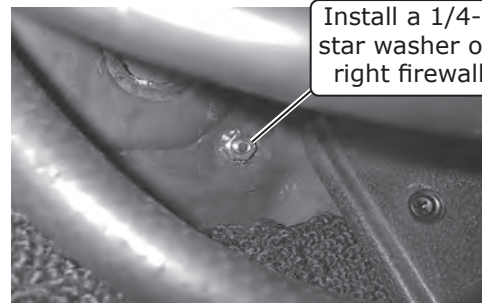

Passenger Compartment View

Photo 6



www.vintageair.com

Passenger Compartment Wiring

1. Select a suitable ground location for the white ground wire eyelet from the heater control valve harness, and secure it using a #10 x 1/2" sheet metal screw.
2. Route the violet power wire to a switched 12v power source on the fuse panel (See Photo 1, below).
NOTE: This requires a male fuse extension (not supplied).
3. Connect the tan wire to the factory dash lights to enable control panel backlighting (if applicable).
4. Connect the BSC wiring to the main harness (See Photo 2, below).
5. Connect the main harness to the ECU (See Photo 3, below).

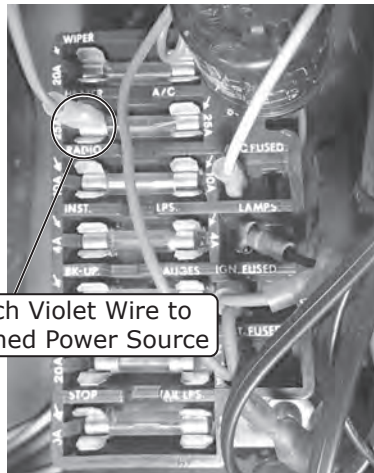

Attach Violet Wire to Switched Power Source

Photo 1

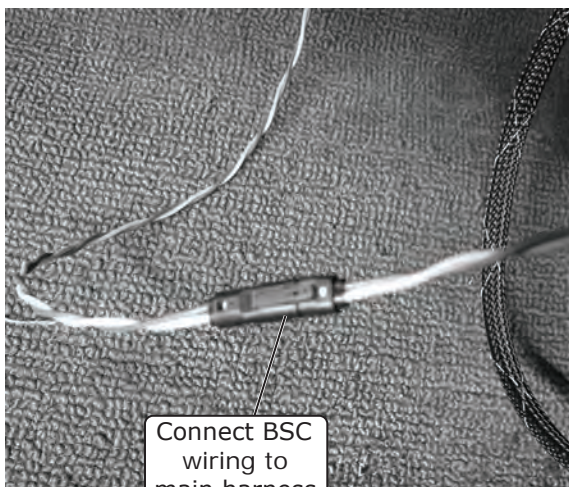

Connect BSC wiring to main harness

Photo 2

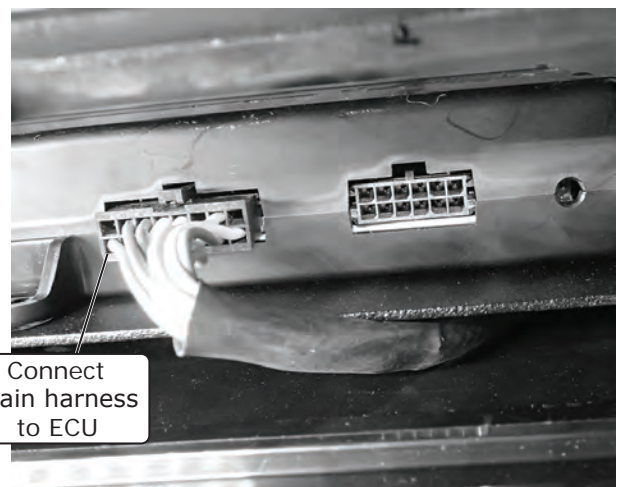

Connect main harness to ECU

Photo 3



www.vintageair.com

ECU, Control Panel & Duct Hose Routing

NOTE: For the system to function optimally, the duct hoses must be routed as directly as possible, taking care to avoid kinks, sharp bends and unnecessary length. Vintage Air supplies duct hoses in continuous lengths that will need to be cut to size depending on application. Before cutting, familiarize yourself with the installation instructions and verify the routing will work with your application. For custom hose routing, additional hose may be needed and can be purchased from Vintage Air.

1. Stretch the duct hose until there is no slack, measure, mark and cut hose to size (See Photo 1, below).

Stretch, measure, mark and cut hose to size



Photo 1

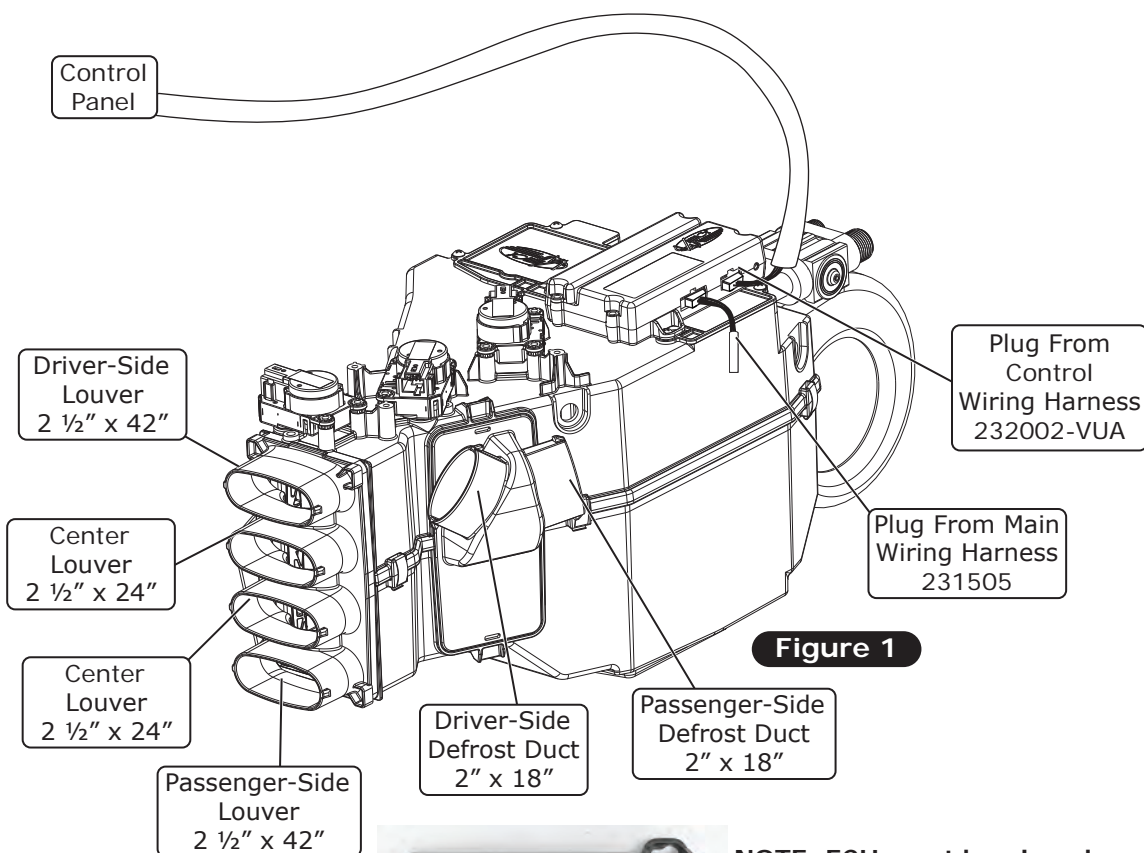

Figure 1



NOTE: ECU must be placed away from water and humidity, and also be accessible for servicing. If relocating, connectors must be positioned towards the bottom.

Position connectors towards bottom



www.vintageair.com

Center Louver Installation

1. Install (2) #8 U-nuts onto the center louver hose adapter (See Figure 1, below).
2. Install (2) .313" length nylon spacers onto the tabs of the center louver vent bracket (Figure 1, below).
3. Install (2) nylon flat washers onto the center vent louver (See Figure 1, below).
4. Insert the center vent louver into the OEM louver housing. Install the center louver vent bracket with (2) nylon spacers onto the housing (See Figure 1, below).
5. Cut a piece of supplied foam, and apply it to the bottom of the louver assembly (See Photo 1, below)
6. Attach (2) 24" lengths of 2 1/2" duct hose to the center louver hose adapter (See Photo 2, below).
7. While holding the center louver assembly and the center louver hose adapter together, align the assembly holes with the holes on the dash. Secure the assembly using (2) #8 x 1/2" screws (See Photo 3, below).

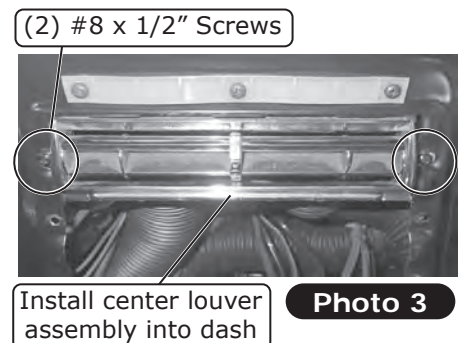
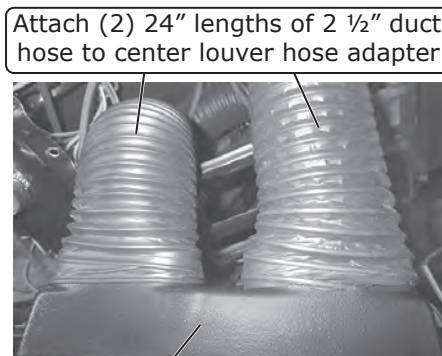
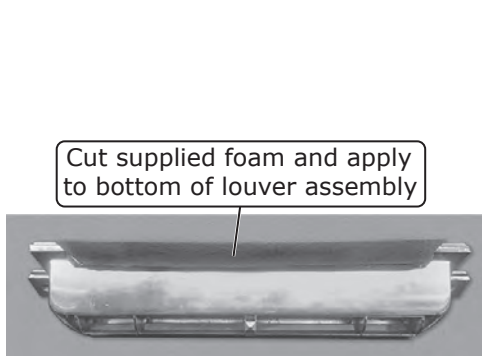
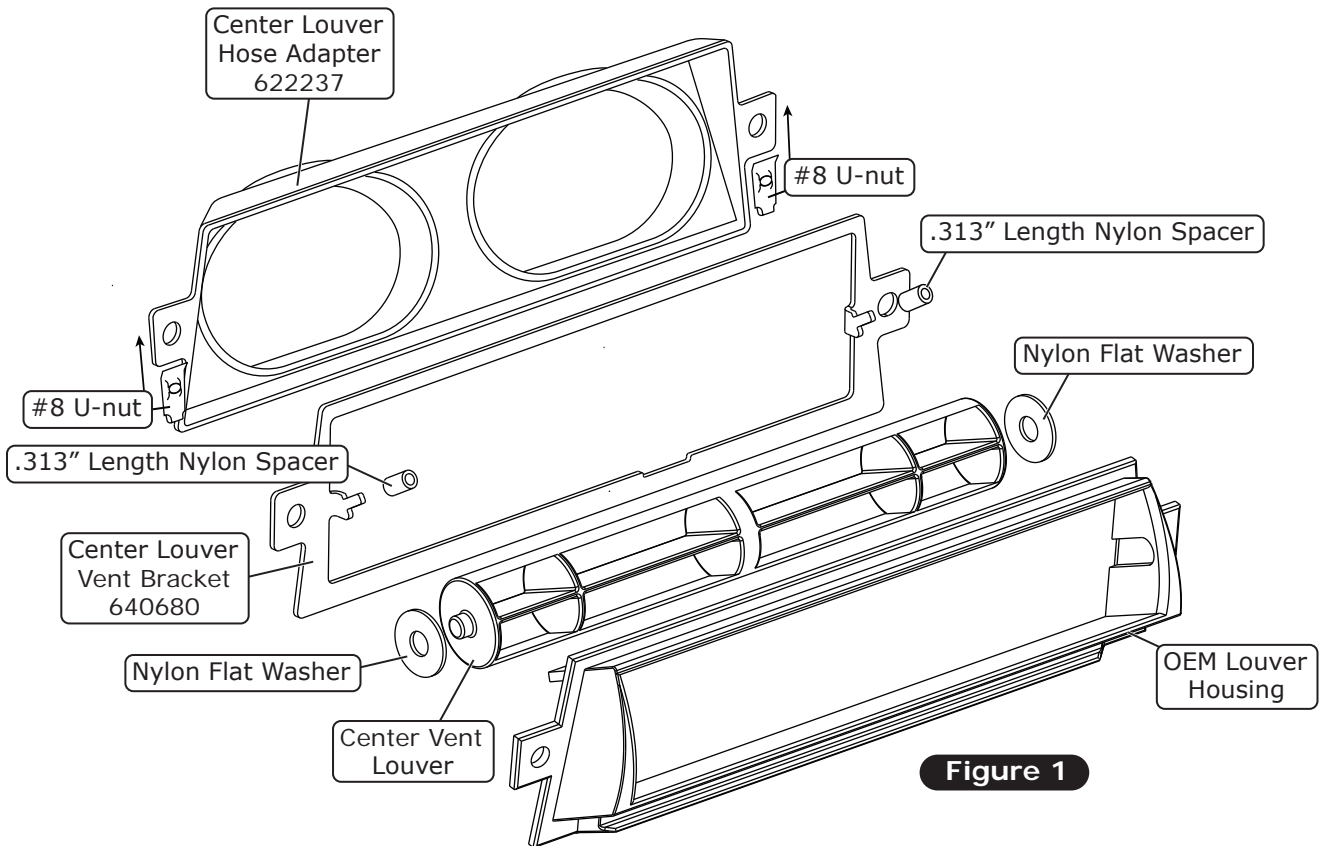



www.vintageair.com

Driver- & Passenger-Side Louver Installation

1. Attach a 42" length of 2 1/2" duct hose to the driver-side louver, then install it into the dash (See Photo 1, below).
2. Attach a 42" length 2 1/2" duct hose to the passenger-side louver, then install it into the dash (See Photo 2, below).

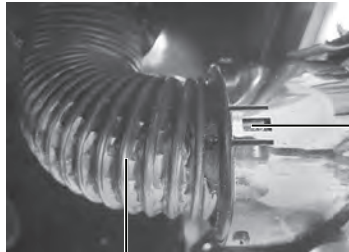

Driver-Side Louver

42" Length of 2 1/2" Duct Hose

Photo 1

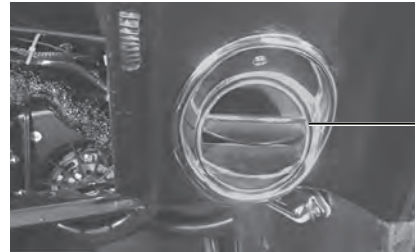

Passenger-Side Louver

Photo 2

Control Panel Installation

1. From the driver side, install the control panel into the dash using the (4) OEM screws (See Photo 1, below).
2. Connect the control panel wiring harness to the ECU (See Photo 2, below).

(4) OEM screws



Photo 1

Connect control panel wiring harness to ECU

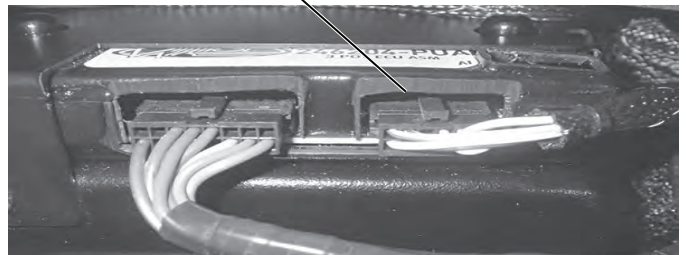

Photo 2

Fresh Air Cap Installation

1. Gently pull the slack from the hoses in the passenger compartment, making sure the hoses are not kinked.
2. Slide the fresh air cap into position, and secure it to the firewall using (2) #14 x 3/4" washer head screws (See Photo 1, below).
3. Apply silicone around the outer edge of the fresh air cap (See Photo 1, below).

Apply silicone around fresh air cap

Secure fresh air cap with (2) #14 x 3/4" washer head screws

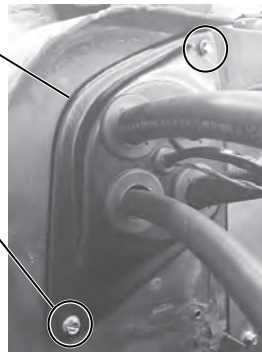

Photo 1



www.vintageair.com

Inner Fender Cover

1. Apply a bead of silicone around the OEM A/C hose opening (See Figure 1, below).
2. Install the inner fender cover using the (4) OEM screws (See Figure 1, below).

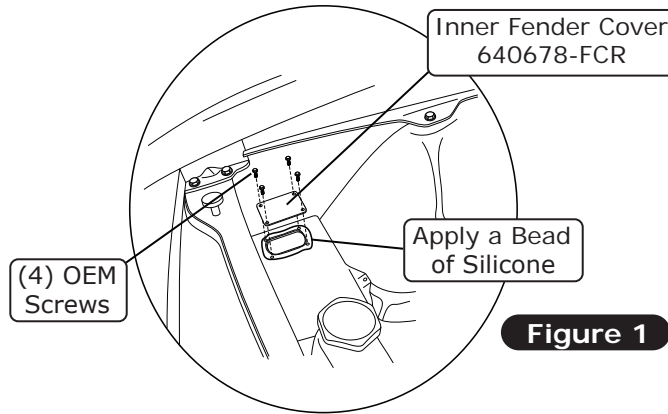

A/C Hose Installation

Standard Hose Kit:

1. Locate the #8 condenser/compressor A/C hose. Lubricate (2) #8 O-rings (See Lubricating O-rings, Page 13), and connect the #8 90° fitting with service port to the #8 discharge port on the compressor (See Photo 1, below). Then, route the 45° fitting to the #8 condenser/core hardline coming from the condenser (See Photo 2, below). Tighten each fitting connection (See Lubricating O-rings, Page 13).
2. Locate the #10 compressor/evaporator A/C hose. Lubricate a #10 O-ring (See Lubricating O-rings, Page 13), and connect the #10 90° fitting with service port to the #10 suction port on the compressor (See Photo 1, below). Tighten the fitting connection (See Lubricating O-rings, Page 13).
3. Locate the #6 drier/evaporator hose. Lubricate a #6 O-ring (See Lubricating O-rings, Page 13), and connect it to the #6 drier/fenderwell hardline coming from the condenser (See Photo 2, below). Tighten the fitting connection (See Lubricating O-rings, Page 13).

Modified Hose Kit:

1. Refer to separate instructions included with modified hose kit.

#10 Compressor/
Evaporator A/C Hose
090176

Compressor

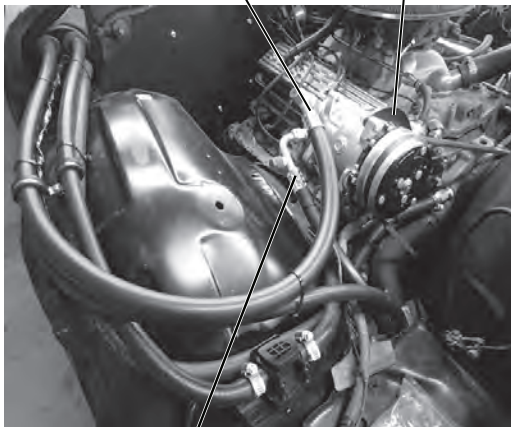

#8 Compressor/
Evaporator A/C Hose
090175

Photo 1

#6 Drier/Evaporator A/C Hose
090174

#6 Drier/Fenderwell Hardline
090173

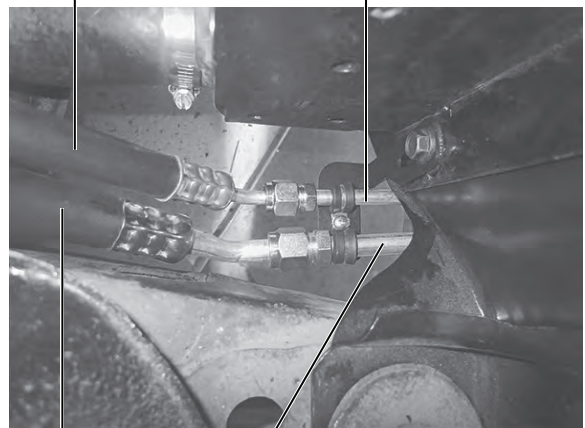

#8 Compressor/
Evaporator A/C Hose
090175

#8 Condenser/
Core Hardline
35367-VCG

Photo 2



www.vintageair.com

Heater Control Valve Installation

NOTE: Vintage Air Systems use 5/8" heater connections. On engines equipped with 3/4" hose nipples, these will need to be removed and replaced with 5/8" nipples (not supplied). For water pumps with a cast-in 3/4" heater outlet, a 3/4" x 5/8" reducer fitting (not supplied) or molded hose (Vintage Air Part # 099010) will need to be installed in the heater hose.

1. Install the heater control valve support bracket onto the heater control valve using (4) #8 x 1/2" pan head screws (See Photo 1, below). **NOTE: Before mounting the heater control valve in the vehicle, ensure the wiring from the main harness and the heater control valve can be connected easily without tension or strain on the connection, or excessive pressure on the metal surfaces.**
2. Route a piece of heater hose (not provided) from the lower heater core fitting to the water pump. Secure using hose clamps (See Photo 2, below).
3. Route a piece of heater hose (not provided) from the intake manifold to the heater control valve. Connect the heater hose from the upper heater core fitting to the heater control valve. Secure using hose clamps (See Figure 1 and Photo 3, below). **NOTE: Ensure proper flow direction through the heater control valve (the flow direction follows the molded arrow on the valve).**
4. Plug the heater control valve connector into the connector on the main wiring harness (See Photo 4, below).
5. Install (2) 1" I.D. Adel clamps to secure the heater hoses (See Photo 5, below). **NOTE: Use an OEM hole to mount the Adel clamps. If an OEM hole is not available, a new hole will need to be drilled. Be sure all hoses are routed away from the fan, belts and pulleys.**

Heater Control Valve Support Bracket 648284

Heater Control Valve 461171

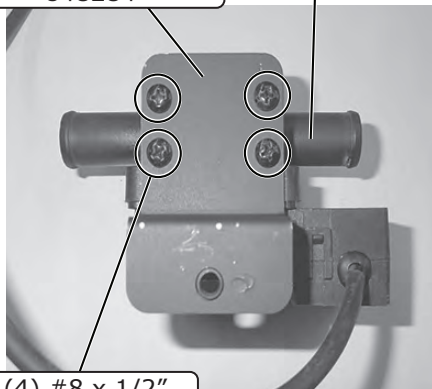

(4) #8 x 1/2" Pan Head Screws

Photo 1

From heater control valve to heater core

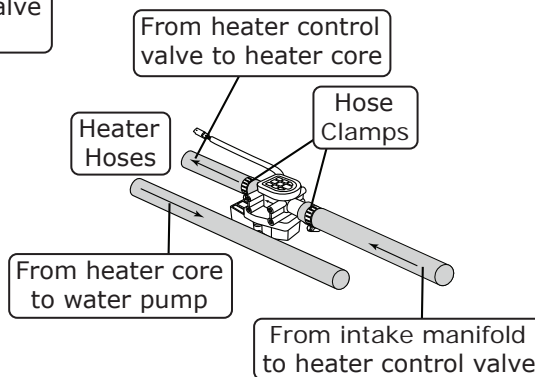

Heater Hoses

Hose Clamps

From heater core to water pump

From intake manifold to heater control valve

NOTE: Flow direction follows molded arrow on valve.

Figure 1

From lower heater core fitting to water pump

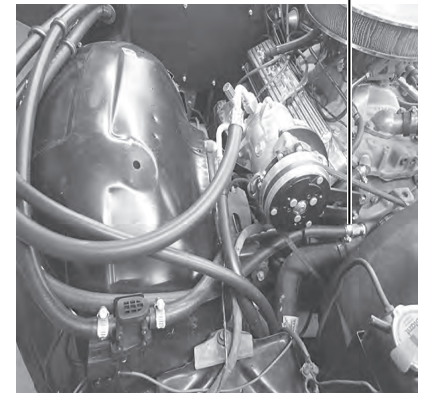
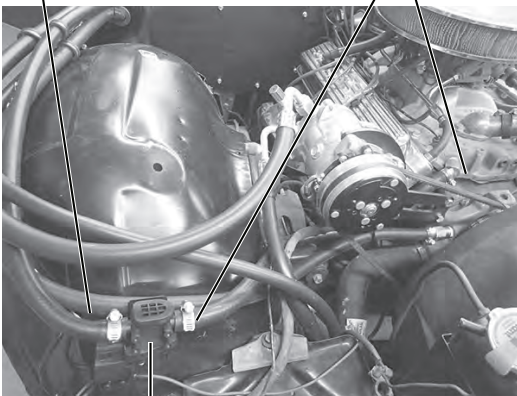

Photo 2

From upper heater core fittings

Intake manifold connection



Heater Control Valve 461171

Photo 3

Heater control valve connector

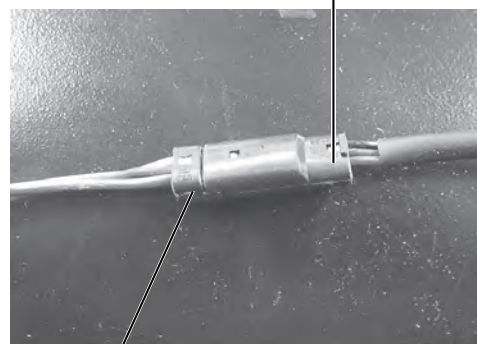

Heater control harness connector

Photo 4

Install (2) 1" I.D. Adel clamps

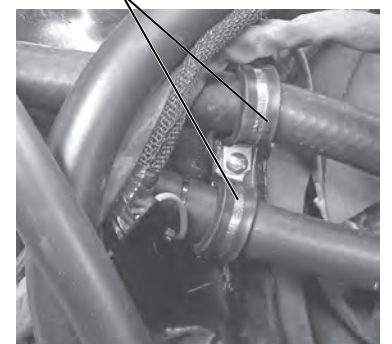

Photo 5

Quality Crimp Guideline

Acceptable strip length
(Some copper visible)

Crimped area is centered
on each side of splice

Bad strip length
(Too much copper visible)
Visible copper should be
just enough to ensure
clearance between splice
area and wire insulation

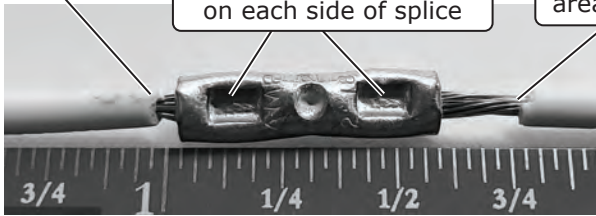

Photo 1

A good crimp requires
seam of butt splice to be
opposite of crimp die tooth

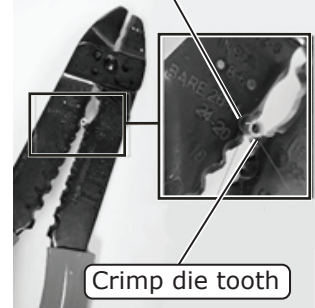
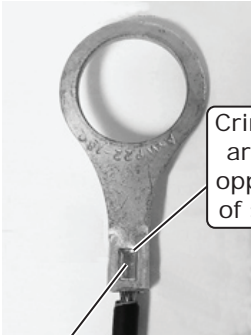

Photo 2

Good Ring Terminal Crimp Bad Ring Terminal Crimp



Crimped area is
opposite of
seam

Photo 3

Crimp
area is
centered
on barrel

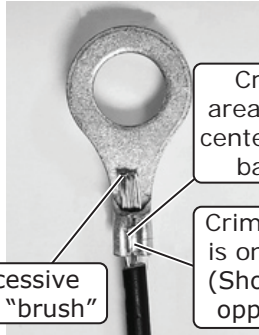

Crimp
area is not
centered on
barrel

Excessive
wire "brush"

Crimp area
is on seam
(Should be
opposite)

Photo 4

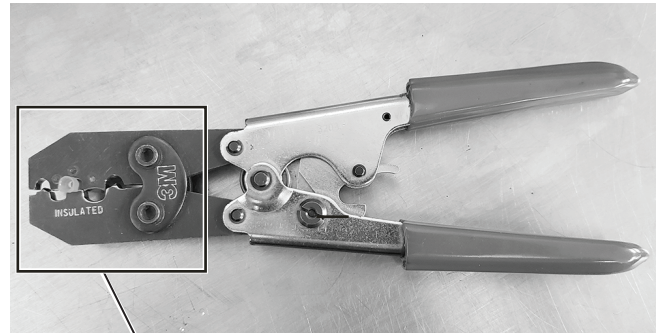

Photo 5

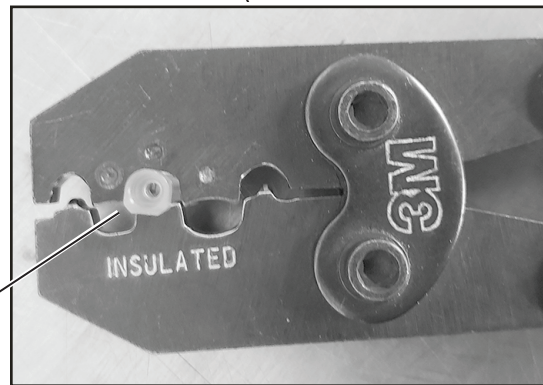

Photo 5a

Use a ratcheting crimp tool
for insulated barrel terminals
when crimping the provided
female insulated terminal.
Ensure terminal is inserted in
appropriate position before
crimping.



www.vintageair.com

Engine Compartment Wiring

1. Route the blue lead from the main wiring harness to the safety switch (See Photo 1, below).
2. Connect the compressor lead wire to the safety switch (See Photo 1, below).
3. Wrap the safety switch wiring with flexo sleeve, and secure it with the supplied tie wraps (See Photo 2, below).
4. Route power and ground wires toward the battery.
5. Install the supplied heat shrink over the 12 AWG orange fuse holder assembly wire, and crimp it to the 12 AWG orange wire from the main wiring harness (See Photo 3, below and Quality Crimp Guidelines, Page 28).
6. Install the supplied heat shrink over the 16 AWG black fuse holder assembly wire, and crimp it to the 16 AWG red wire from the main wiring harness (See Photo 4, below and Quality Crimp Guidelines, Page 28).

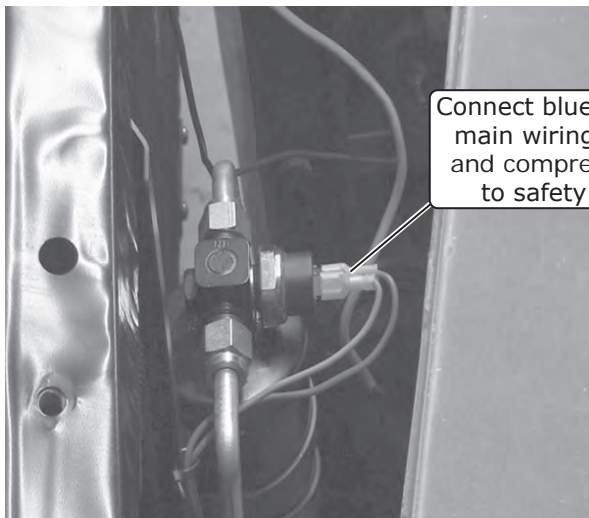

Photo 1

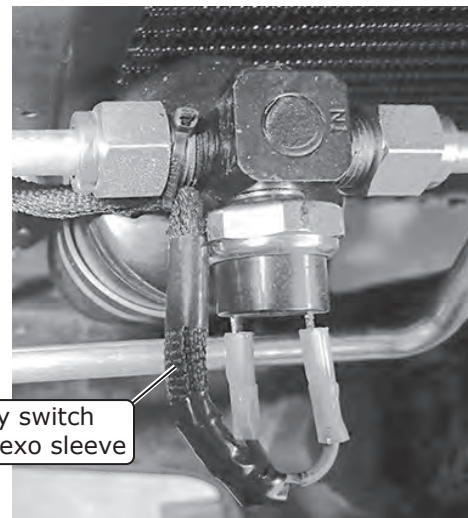

Photo 2

Install supplied heat shrink over 12 AWG orange fuse holder assembly and crimp to 12 AWG orange wire from main wiring harness

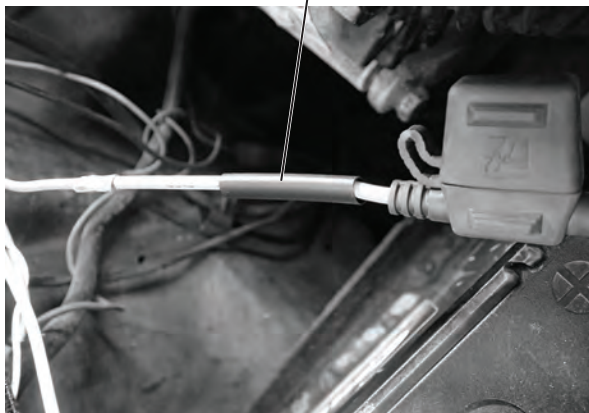

Photo 3

Install supplied heat shrink over 16 AWG black fuse holder assembly wire and crimp to 16 AWG red wire from main wiring harness

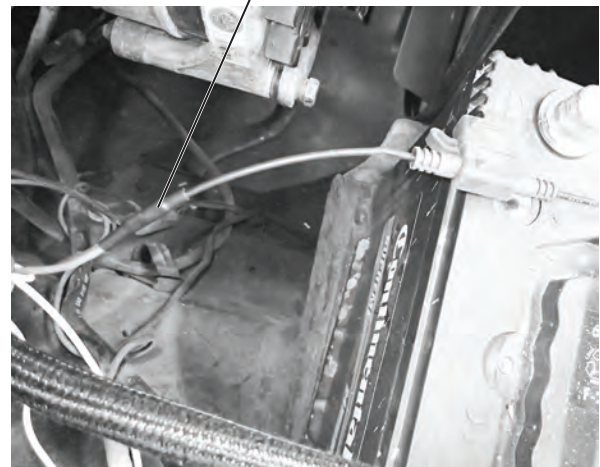

Photo 4



www.vintageair.com

Engine Compartment Wiring (Cont.)

7. Install fuses into the holders (See Photo 5, below).
 8. Install the supplied heat shrink over the white ground wires, then crimp on the supplied eyelets (See Photos 6 and 7, below and Quality Crimp Guidelines, Page 28)
 9. Connect the ground wiring eyelets to the negative battery terminal connector (See Photo 8, below).
 10. Connect the positive wiring eyelets to the positive battery terminal connector (See Photo 9, below).
- NOTE: Do not connect power until installation is completed.**

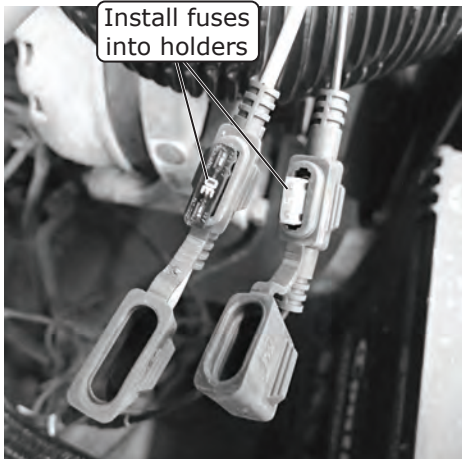

Photo 5

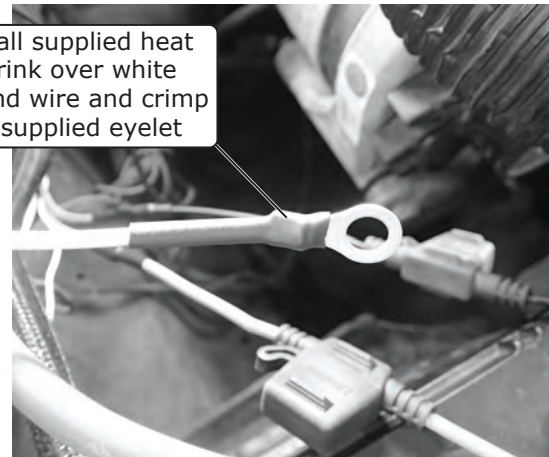

Photo 6

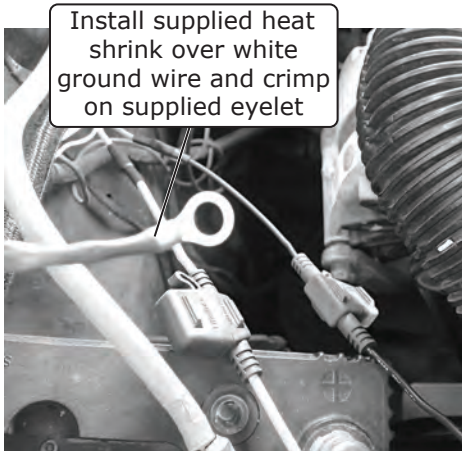

Photo 7

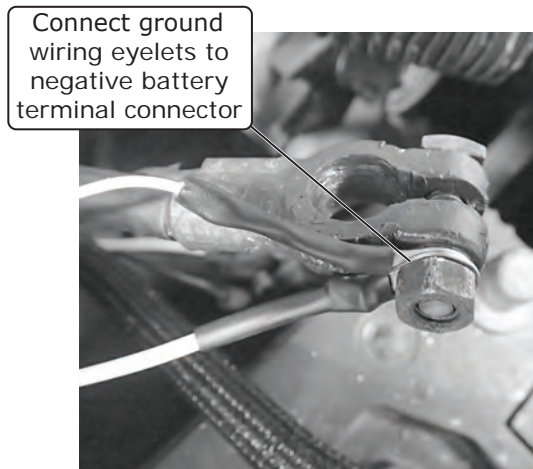

Photo 8

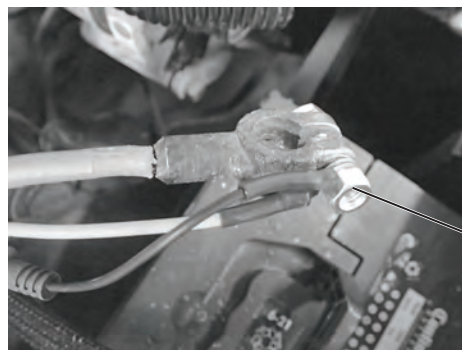

Photo 9

NOTE: Do not connect power until installation is completed.

Connect positive wiring eyelets to positive battery terminal connector



www.vintageair.com

Final Steps: Installation Check

Installation Check	
ITEM TO CHECK	Procedure
<input type="checkbox"/>	<p>ECU</p> <p>If no blinking is observed after 1 minute of turning the ignition on, go to the next check.</p> <p>If repetitive blinking is observed, go to the Advanced Diagnostics Section to diagnose.</p>
<input type="checkbox"/>	<p>Blower speed control</p> <p>Set the blower speed control to OFF, <u>confirm that the blower is off</u>.</p> <p>Position the blower speed control to LOW then MEDIUM and then HIGH. <u>At each setting confirm that the blower speed increases</u>, do this by feeling for the amount of air coming from the unit and hearing the blower speed increase.</p>
<input type="checkbox"/>	<p>Mode control</p> <p>Set the MODE control to the DASH position. <u>Confirm that air is being blown at the dash vents</u>.</p> <p>Set the MODE control to the FLOOR position. <u>Confirm that air is being blown at the floor vents</u>.</p> <p>Set the MODE control to the DEFROST position. <u>Confirm that all air is being blown from the defrost vents</u></p> <p>If heater lines are installed:</p> <p>Set the MODE control to the DASH position. Set the TEMP control to the MAX HEAT position. <u>Confirm that HOT air is coming from the dash vents</u>.</p>
<input type="checkbox"/>	<p>Temperature control</p> <p>If system is charged:</p> <p>Set the TEMP control to the MAX COOL position. <u>Confirm that COLD air is coming from the dash vents</u>.</p> <p>Also <u>confirm that the compressor "clicks" on</u> when adjusting the TEMP control from the MAX HEAT position to the MAX COOL position.</p>
<input type="checkbox"/>	<p>AC Indicator (If applicable)</p> <p>While the MODE control is set to the DASH position, and the TEMP control is set to the MAX COOL/MIN HEAT position, <u>confirm that the blue AC Indicator light is on</u>.</p>
<input type="checkbox"/>	<p>Backlight (If applicable)</p> <p>If your control panel has backlight capabilities and has been wired, turn the dash lamp on and <u>confirm that the AC panel's legend is lit</u>.</p>
<input type="checkbox"/>	<p>Fittings</p> <p>Verify AC and Heater fittings are all tight.</p>



www.vintageair.com

ECU Mounting

1. Select a suitable location behind the dashboard and clean the area where the ECU will be mounted.
2. Apply (2) strips of Velcro onto the back of the ECU (See Photo 1, below) and mount it in the selected location.

Apply (2) strips of Velcro onto the back of ECU

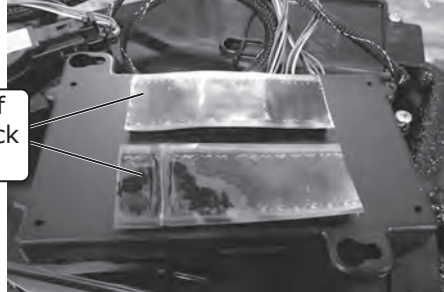

Photo 1

Glove Box Installation

NOTE: Before installing the glove box, install a #8 U-nut onto the bottom-right hole on the supplied glove box bottom (See Photo 1, below).

1. Insert the supplied glove box bottom into the glove box opening. Install a #8 x 1/2" pan head screw into the mounting holes on each side of the glove box opening (See Photo 2, below).
2. Insert the glove box top into the glove box opening, then attach the bottom half of the glove box to the top half using (3) 10-32 x 1/2" screws (See Photo 3, below). **NOTE: Route the glove box light wiring through the cutout on the top half of glove box (See Photo 4, below).**
3. Secure the glove box top to the glove box opening using (2) #8 x 1/2" pan head screws (See Photo 5, below).
4. Reinstall the glove box door using (3) #8 x 1/2" pan head screws (See Photo 6, below). **NOTE: When installing the glove box door, be sure the screws install into the #8 U-nuts on the dash bracket.**
5. Install the glove box door latch using (2) OEM screws.
6. Reinstall the glove box door light (See Photo 7, below).

Install #8 U-nut onto glove box bottom



Photo 1

Glove Box Bottom 622231

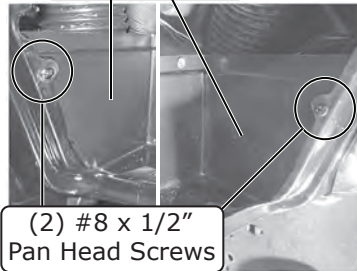

(2) #8 x 1/2" Pan Head Screws

Photo 2

Glove Box Top 622232

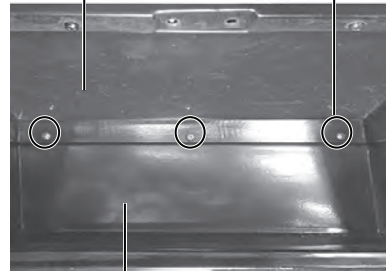

Install (3) 10-32 x 1/2" Screws

Glove Box Bottom 622231

Photo 3

Route wiring through cutout



Photo 4

Secure glove box top using (2) #8 x 1/2" screws



Photo 5

Reinstall glove box door using (3) #8 x 1/2" screws

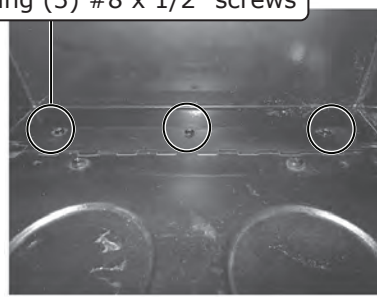

Photo 6

Reinstall glove box light



Photo 7



www.vintageair.com

Kick Panel Vent Actuator Cover Installation

1. Trim to fit, then reinstall the kick panel vent actuator cover using (4) #8 x 1 1/4" countersunk screws with washers (See Photo 1, below).

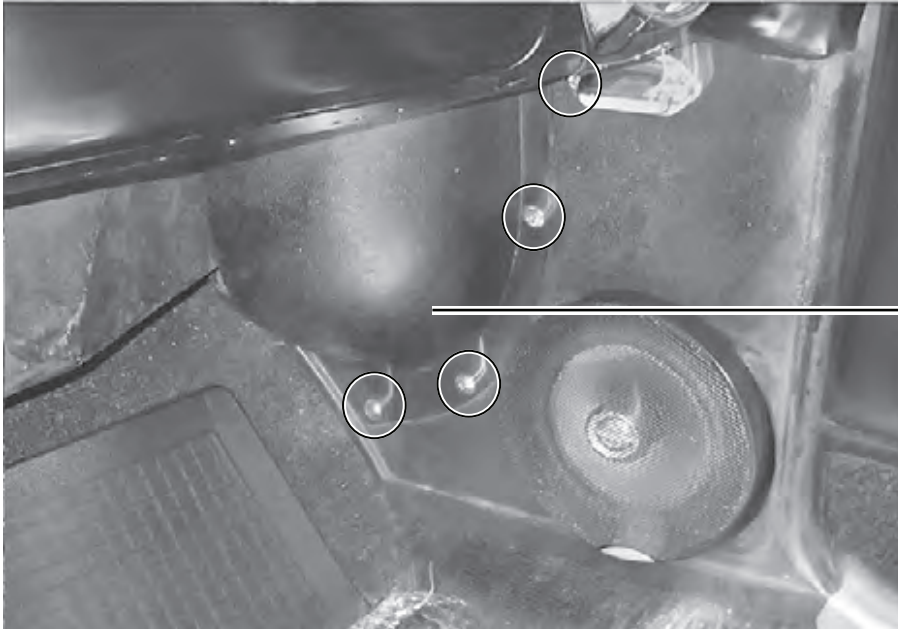

Trim to fit, then reinstall with (4) #8 x 1 1/4" countersunk screws with washers

Final Steps: Completing the Install

1. Reinstall all previously removed items.
2. Fill radiator with at least a 50/50 mixture of approved antifreeze and distilled water. It is the owner's responsibility to keep the freeze protection at the proper level for the climate in which the vehicle is operated. Failure to follow antifreeze recommendations will cause heater core to corrode prematurely and possibly burst in A/C mode and/or freezing weather, voiding your warranty.
3. Double check all fittings, brackets and belts for tightness.
4. Vintage Air recommends that all A/C systems be serviced by a licensed automotive A/C technician.
5. Evacuate the system for a minimum of 45 minutes prior to charging, and perform a leak check prior to servicing.
6. Charge the system to the capacities stated on Page 4 of this instruction manual.
7. See Operation of Controls procedures on Page 36.

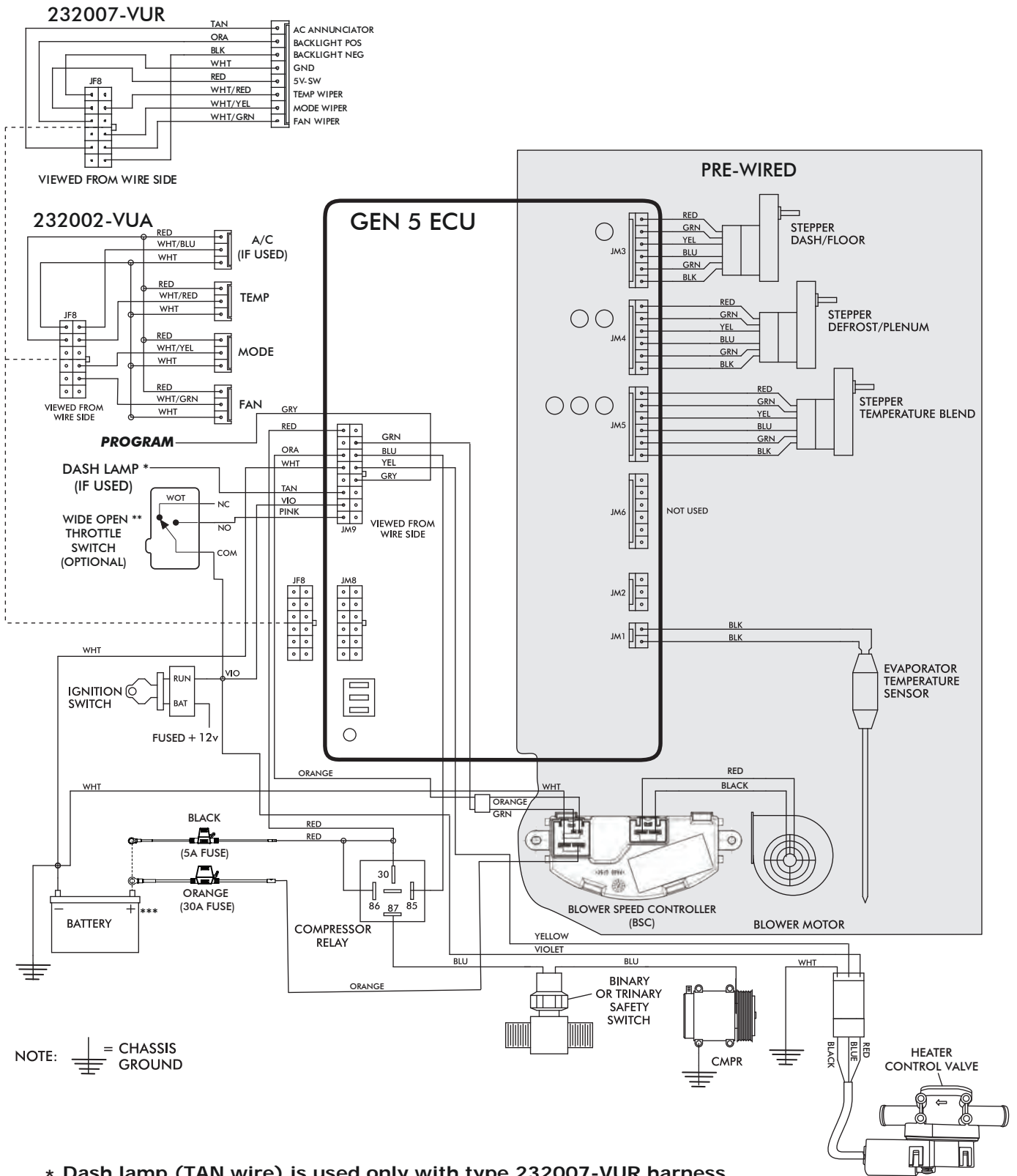

NOTE: = CHASSIS GROUND

- * Dash lamp (TAN wire) is used only with type 232007-VUR harness.
- ** Wide open throttle switch contacts close only at full throttle, which disables A/C compressor.
- *** Install fuse assemblies at or as near to the battery as possible.



www.vintageair.com

Gen 5 Wiring Instructions

WIRING HARNESS (231505) ↓

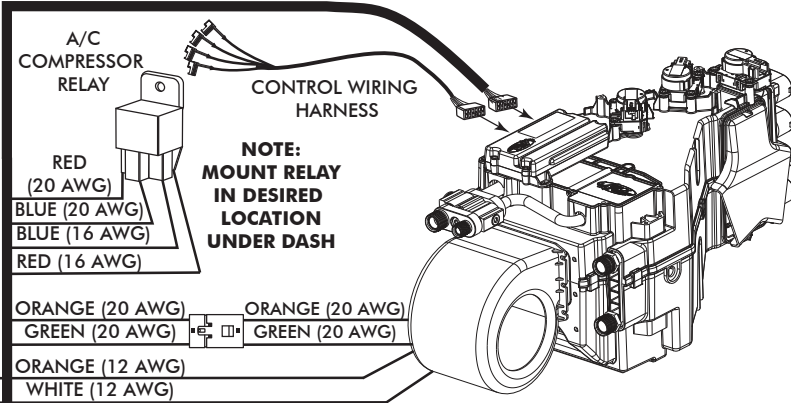

NOTE:
MOUNT RELAY
IN DESIRED
LOCATION
UNDER DASH

Ignition Switch:

Using provided butt splice (PN 226004), connect the 20 AWG violet wire to a 5A fused and switched 12V source such as Key On.

Wide Open Throttle Switch (Optional):

If a wide open throttle switch is required, connect the 20 AWG pink wire to a normally open switch that, when closed, connects a fused and switched 12V source to the pink wire. See Gen 5 wiring diagram for an example.

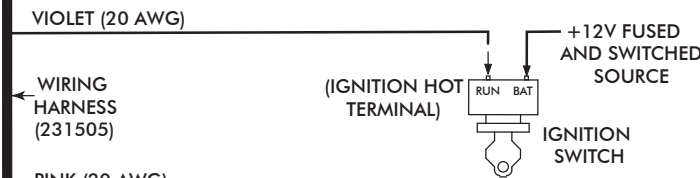

Dash Light (Optional):

If using a Vintage Air control panel with back light, connect the 20 AWG tan wire to the vehicle's dash back light 0-12V using provided butt splice (PN 226004).

WIRING HARNESS (232020) →

FIREWALL

FIREWALL

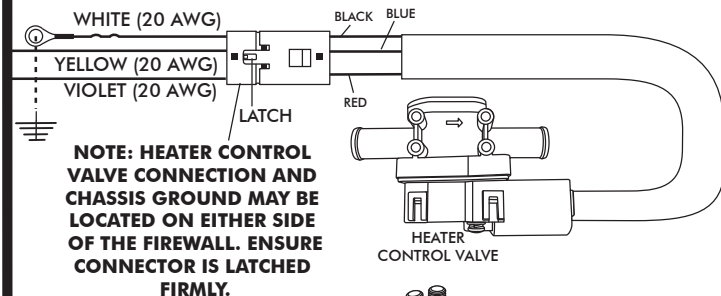

NOTE: HEATER CONTROL VALVE CONNECTION AND CHASSIS GROUND MAY BE LOCATED ON EITHER SIDE OF THE FIREWALL. ENSURE CONNECTOR IS LATCHED FIRMLY.

Heater Control Valve:

Connect the Violet/Yellow/White twisted branch with 3 position connector into the heater control valve connector. Ensure that the mating latch is fully seated.

Binary/Trinary & Compressor:

Binary Switch: Terminate provided insulated female terminal (PN 23172-VUW) to the blue 16 AWG wire. Connect as shown.
Trinary Switch: Connect according to trinary switch wiring diagram.

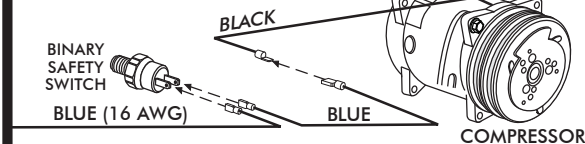

Battery Connections:

ECU Ground: Terminate provided ring terminal (PN 226110) to 20 AWG white wire from the 231505 wire assembly and install at battery.
ECU PWR: Terminate provided fuse assembly with black leads (PN 233012) to the 20 AWG red wire from the 231505 wire assembly. Install provided 5A Brown Mini Fuse (PN 226118). Install at battery.
Blower Speed Controller (BSC) Ground: Terminate provided ring terminal (PN 226111) to 12 AWG white wire from the 232020 wire assembly and install at battery.
Blower Speed Controller (BSC) PWR: Terminate provided fuse assembly with orange leads (PN 233008) to the 12 AWG orange wire from the 232020 wire assembly. Install provided 30A Green ATO/ATC Fuse (PN 226125). Install at battery.

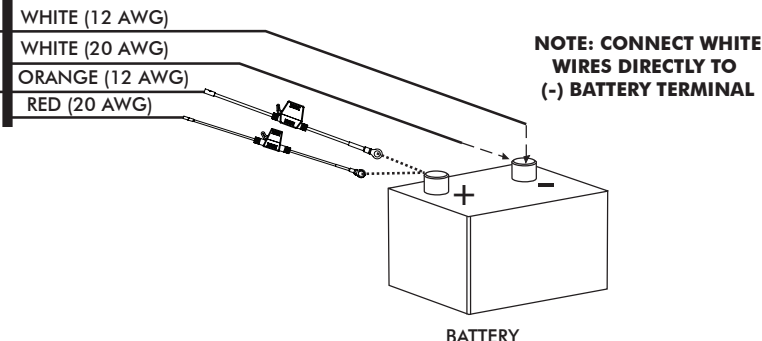

NOTE: CONNECT WHITE WIRES DIRECTLY TO (-) BATTERY TERMINAL



www.vintageair.com

Operation of Controls

On Gen IV or Gen 5 systems with three lever/knob controls, the temperature control toggles between heat and A/C operations. To activate A/C, move the temperature lever/knob all the way to cold and then back it off to the desired vent temperature. For heat operation, move the temperature lever/knob all the way to hot and then adjust to the desired vent temperature. The blower will momentarily change speed, each time you toggle in and out of heat and A/C operations, to indicate the change. **NOTE: For proper control panel function, refer to the control panel instructions for calibration procedure.**

Blower Speed

This lever/knob controls blower speed, from OFF to HI.

Mode Control

This lever/knob controls the mode positions, from DASH to FLOOR to DEFROST, with a blend in between.

Temperature Control

This lever/knob controls the temperature, from HOT to COLD.

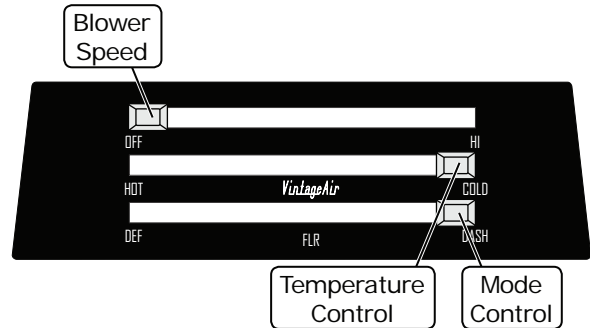

A/C Operation

Blower Speed

Adjust to desired speed.

Mode Control

Adjust to desired mode position (DASH position recommended).

Temperature Control

For A/C operation, adjust to coldest position to engage compressor (adjust between HOT and COLD to reach desired temperature).



Heat Operation

Blower Speed

Adjust to desired speed.

Mode Control

Adjust to desired mode position (FLOOR position recommended).

Temperature Control

For maximum heating, adjust to hottest position (adjust between HOT and COLD to reach desired temperature).



Defrost/De-fog Operation

Blower Speed

Adjust to desired speed.

Temperature Control

Adjust to desired temperature.

Mode Control

Adjust to DEFROST position for maximum defrost, or between FLOOR and DEFROST positions for a bi-level blend (Compressor is automatically engaged).





www.vintageair.com

Troubleshooting Guide

This printed troubleshooting guide is our basic guide that covers common installation problems. To see our advanced diagnostics and troubleshooting guide, please refer to the following page for instructions on how to download the complete guide.

WARNING: While troubleshooting the system, never probe connector terminals from the front mating side, only back probe.

WARNING: While troubleshooting the system, never use automotive check lights.

Symptom	Condition	Checks	Actions	Notes
1. Blower stays on high speed with ignition on.	No other functions work.	Check for damaged pins or wires in the control panel wire assembly and mating header at ECU.	If found damaged, replace wire assembly or ECU.	If fuse continues to blow, there is a serious problem in the wiring. Check all wiring and ensure the wire is not damaged and shorting out along its route.
	All other functions work.	Check for a bad ECU GND. Check for damaged pins or wires in the control panel wire assembly and mating header at ECU. Check if Blower power fuse is blown. Check for a bad ECU GND.	If found damaged, replace wire assembly or ECU. Replace fuse. Repair connection.	
2. Compressor will not turn on (All other functions work).	System is not charged.	System must be charged for compressor to engage.	Charge system.	Danger: Never bypass safety switch with engine running. Serious injury can result.
	System is charged.	Check for faulty A/C potentiometer or associated wiring (not applicable to 3-pot controls).	Check continuity to ground on white control head wire. Check for 5V on red control head wire.	To check for proper pot function, check voltage at white/red wire. Voltage should be between 0V and 5V, and will vary with pot lever position.
		Check for disconnected or faulty thermistor.	Check 2-pin connector at ECU housing.	Disconnected or faulty thermistor will cause compressor to be disabled.
3. Compressor will not turn off (All other functions work).	Compressor will not turn off (All other functions work).	Check for faulty A/C potentiometer or associated wiring.	Repair or replace pot/control wiring.	Red wire at A/C pot should have approximately 5V with ignition on. White wire will have continuity to chassis ground. White/Red wire should vary between 0V and 5V when lever is moved up or down.
		Check for faulty A/C relay.	Replace relay.	



www.vintageair.com

Troubleshooting Guide (Cont.)

Symptom	Condition	Checks	Actions	Notes
4. System will not turn on, or runs intermittently.	Works when engine is not running; shuts off when engine is started	Noise interference from either ignition or alternator.	Install capacitors on ignition coil and alternator. Ensure good ground at all points. Relocate coil and associated wiring away from ECU and ECU wiring. Check for burned or loose plug wires.	Ignition noise (radiated or conducted) will cause the system to shut down due to high voltage spikes. If this is suspected, check with a quality oscilloscope. Spikes greater than 16V will shut down the ECU. Install a radio capacitor at the positive post of the ignition coil (see radio capacitor installation bulletin). A faulty alternator or worn out battery can also result in this condition.
	Will not turn on under any conditions.	Verify connections on power lead, ignition lead, and both white ground wires. Verify battery voltage is greater than 10 volts and less than 16 while engine is running.	Check for power at ECU, and confirm ignition is being applied to ECU properly. Verify proper meter function by checking the condition of a known good battery.	
5. Loss of mode door function.	No mode change at all.	Check for damaged mode switch or potentiometer and associated wiring.		
	Blower turns on and off rapidly.	Battery voltage is at least 12V. Battery voltage is less than 12V.	Ensure all system grounds and power connections are clean and tight. Charge battery.	System shuts off blower at 10V. Poor connections or weak battery can cause shutdown at up to 11V.
7. Erratic functions of blower, mode, temp, etc.		Check for damaged switch or pot and associated wiring.	Repair or replace.	

Advanced Diagnostics and Troubleshooting Guide

If after referencing the Troubleshooting Guide, the issue is not resolved, move to The Advanced Diagnostics and Troubleshooting Guide that covers the following:

- ECU Diagnostics Codes
- 1. ECU Blink Sequence
- 2. Firmware Version Number
- 3. ECU Model Number
- 4. ECU Start-Up Blink Sequence
- 5. Diagnostic Codes
- Complete Advanced Troubleshooting Guidelines

Access the latest version of the Advanced Diagnostics and Troubleshooting Guide by scanning the following QR code on your mobile device:



You can also access the guide by typing the following address into your web browser:

https://www.vintageair.com/instructions_pdf/905000.pdf



www.vintageair.com

Packing List: Evaporator Kit (564244)

No.	Qty.	Part No.	Description
1.	1	765200	Gen 5 Super Magnum Module
2.	1	784244	Accessory Kit

Checked By: _____
Packed By: _____
Date: _____

1



Gen 5 Super Magnum
Module
765200

2

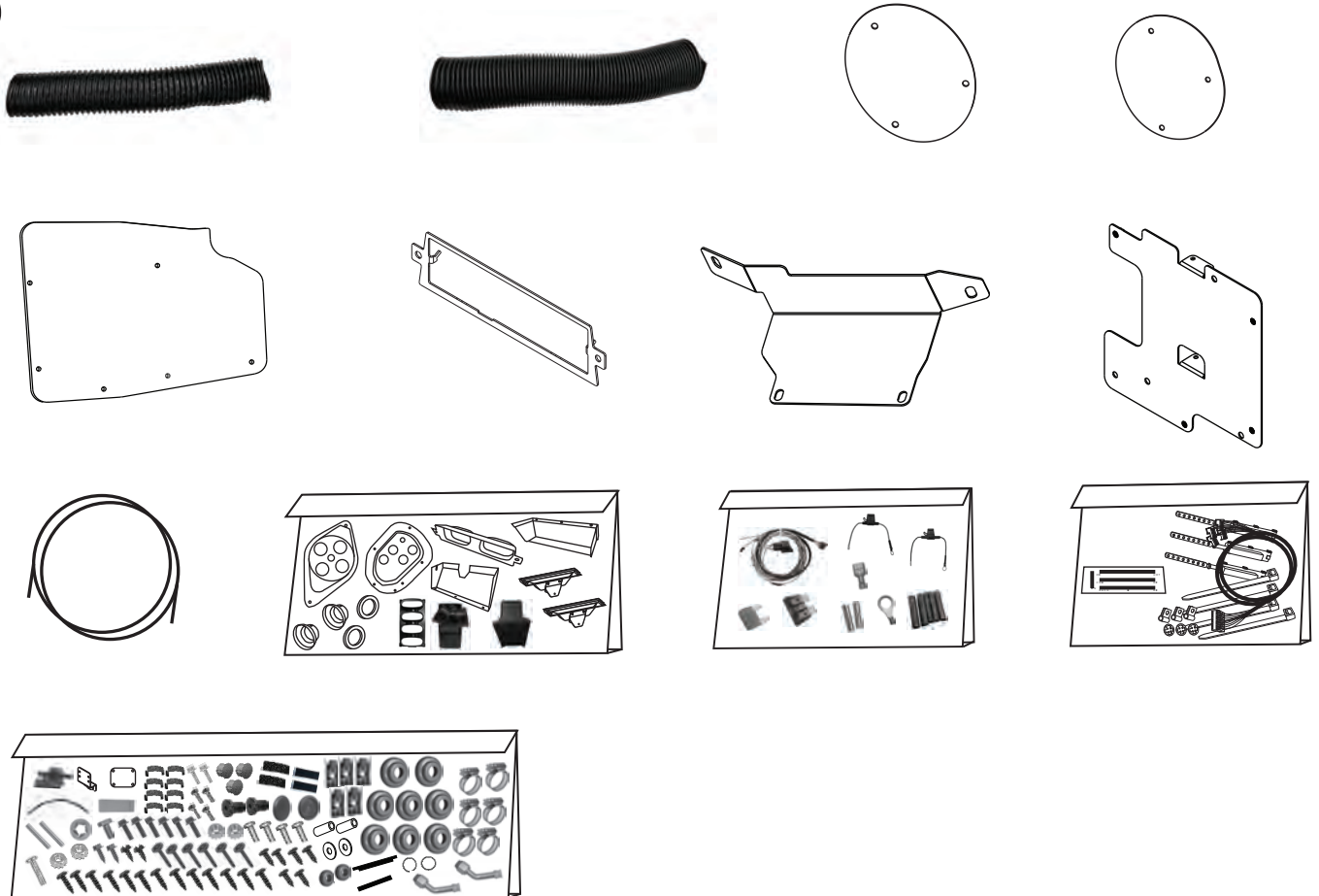

Accessory Kit
784244

**NOTE: Images may not depict actual parts and quantities.
Refer to packing list for actual parts and quantities.**