



1957 Chevrolet Full-Size

without Factory Air

Gen 5 Evaporator Kit

Center Vent (561552)

Center Vent Deluxe (561556)



18865 Goll St. San Antonio, TX 78266

Phone: 800-862-6658

Sales: sales@vintageair.com

Tech Support: tech@vintageair.com

www.vintageair.com



www.vintageair.com

Table of Contents

Cover.....	1
Table of Contents.....	2
Packing List/Parts Disclaimer.....	3
Information Page.....	4
Wiring Notice.....	5
Engine Compartment Disassembly.....	6-7
Passenger Compartment Disassembly.....	8-10
Lubricating O-rings, Properly Seated O-ring Land.....	11
Evaporator Preparation.....	12-14
Firewall Modification for Ring Bracket.....	15
Firewall Insulation.....	16
Ring Bracket, Firewall Rubber Boot & Fresh Air Plate Installation, Hood Hinge Reinstallation.....	17
Defrost Duct Installation, Wiring Installation.....	18
A/C Hose Routing, Evaporator Installation.....	19-21
Control Panel Installation, ECU Installation.....	22
Passenger Compartment Wiring, Drain Hose Installation.....	23
Driver- and Passenger-Side Louver Installation.....	24-25
Glove Box Installation.....	26
Fresh Air Vent Duct Cap Installation, A/C Hose Installation.....	27
Heater Hose & Heater Control Valve Installation.....	28
A/C and Heater Hose Routing.....	29
Engine Compartment Wiring.....	30-32
Final Steps: Completing the Install.....	33
Final Steps: Installation Check.....	34
ECU, Control Panel & Duct Hose Routing.....	35
Quality Crimp Guideline.....	36
Gen 5 Wiring Diagram.....	37
Gen 5 Wiring Connection Instruction.....	38
Operation of Controls.....	39
Troubleshooting Guide.....	40
Troubleshooting Guide (Cont.), Advanced Diagnostics and Troubleshooting Guide.....	41
Packing List.....	42



www.vintageair.com

Packing List: Evaporator Kit (561552)

No.	Qty.	Part No.	Description
1.	1	765200	Gen 5 Super Magnum Module with 404 ECU
2.	1	781552	Accessory Kit

**** Before beginning installation, open all packages and check contents of shipment. Please report any shortages directly to Vintage Air within 15 days. After 15 days, Vintage Air will not be responsible for missing or damaged items.**

1

Gen 5 Super Magnum
Module with 404 ECU
765200



2

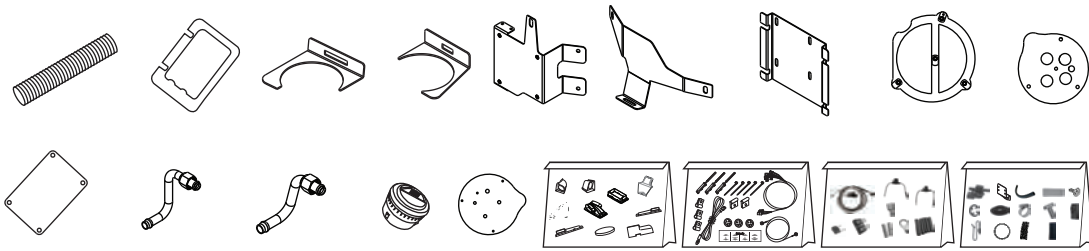

Accessory Kit
781552

NOTE: Images may not depict actual parts and quantities. Refer to packing list for actual parts and quantities.

Packing List: Evaporator Kit (561556)

No.	Qty.	Part No.	Description
1.	1	765200	Gen 5 Super Magnum Module with 404 ECU
2.	1	781556	Accessory Kit

**** Before beginning installation, open all packages and check contents of shipment. Please report any shortages directly to Vintage Air within 15 days. After 15 days, Vintage Air will not be responsible for missing or damaged items.**

1

Gen 5 Super Magnum
Evaporator Module
765200



2

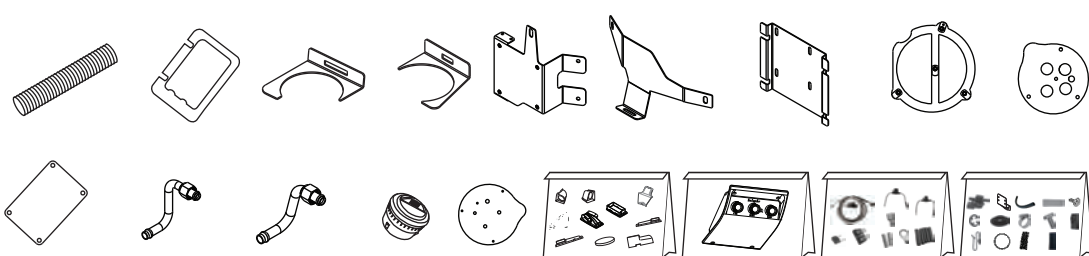

Accessory Kit
781556

NOTE: Images may not depict actual parts and quantities. Refer to packing list for actual parts and quantities.



www.vintageair.com

Important Notice—Please Read

For Maximum System Performance, Vintage Air Recommends the Following:

NOTE: Vintage Air systems are designed to operate with R134a refrigerant only. Use of any other refrigerant could damage your A/C system and/or vehicle, and possibly cause a fire, in addition to potentially voiding the warranties of the A/C system and its components.

Refrigerant Capacities:

Vintage Air System: 1.8 lbs. (28.8 oz.) or 816 grams of **R134a**, charged by weight with a quality charging station or scale. **NOTE: Use of the proper type and amount of refrigerant is critical to system operation and performance.**

Other Systems: Consult manufacturer's guidelines.

Lubricant Capacities:

New Vintage Air-Supplied Sanden Compressor: No additional oil needed (Compressor is shipped with proper oil charge).

All Other Compressors: Consult manufacturer (Some compressors are shipped dry and will need oil added).

Safety Switches

Your Vintage Air system is equipped with a binary pressure safety switch. A binary switch disengages the compressor clutch in cases of extreme low pressure conditions (refrigerant loss) or excessively high head pressure (406 PSI) to prevent compressor damage or hose rupture. A trinary switch combines Hi/Lo pressure protection with an electric fan operation signal at 254 PSI, and should be substituted for use with electric fans. Compressor safety switches are extremely important since an A/C system relies on refrigerant to circulate lubricant.

Service Info:

Protect Your Investment: Prior to assembly, it is critical that the compressor, evaporator, A/C hoses and fittings, hardlines, condenser and receiver/drier remain capped. Removing caps prior to assembly will allow moisture, insects and debris into the components, possibly leading to reduced performance and/or premature failure of your A/C system. This is especially important with the receiver/drier.

Additionally, when caps are removed for assembly, **BE CAREFUL!** Some components are shipped under pressure with dry nitrogen.

Evacuate the System for 35-45 Minutes: Ensure that system components (Drier, compressor, evaporator and condenser) are at a temperature of at least 85°F. On a cool day, the components can be heated with a heat gun **or** by running the engine with the heater on before evacuating. Leak check and charge to specifications.

Bolts Passing Through Cowl and/or Firewall:

To ensure a watertight seal between the passenger compartment and the vehicle exterior, for all bolts passing through the cowl and/or firewall, Vintage Air recommends coating the threads with silicone prior to installation.

Heater Hose (not included with this kit):

Heater hose may be purchased from Vintage Air (Part#31800-VUD) or your local parts retailer. Routing and required length will vary based on installer preference.



www.vintageair.com

Important Wiring Notice—Please Read

Some vehicles may have had some or all of their radio interference capacitors removed. There should be a capacitor found at each of the following locations:

- 1. On the positive terminal of the ignition coil.**
- 2. If there is a generator, on the armature terminal of the generator.**
- 3. If there is a generator, on the battery terminal of the voltage regulator.**

Most alternators have a capacitor installed internally to eliminate what is called “whining” as the engine is revved. If whining is heard in the radio, or just to be extra cautious, a radio interference capacitor can be added to the battery terminal of the alternator.

It is also important that the battery lead is in good shape and that the ground leads are not compromised. There should be a heavy ground from the battery to the engine block, and additional grounds to the body and chassis.

If these precautions are not observed, it is possible for voltage spikes to be present on the battery leads. These spikes come from ignition systems and charging systems, and from switching some of the vehicle’s other systems on and off. Modern computer-operated equipment can be sensitive to voltage spikes on the power leads, which can cause unexpected resets, strange behavior and/or permanent damage.

Vintage Air strives to harden our products against these types of electrical noise, but there is a point where a vehicle’s electrical system can be degraded so much that nothing can help.

Radio interference capacitors should be available at most auto and truck parts suppliers. They typically are cylindrical in shape, a little over an inch long and a little over a half-inch in diameter, and they have a single lead coming from one end of the cylinder with a terminal on the end of the wire, as well as a mounting clip which is screwed into a good ground on the vehicle. The specific value of the capacitance is not too significant in comparison to ignition capacitors that are matched with the coil to reduce pitting of the points.

- Care must be taken, when installing the compressor lead, not to short it to ground. The compressor lead must not be connected to a condenser fan or to any other auxiliary device. Shorting to ground or connecting to a condenser fan or any other auxiliary device may damage wiring or the compressor relay, and/or cause a malfunction.
- When installing ground leads on Gen 5 systems, the blower control ground and ECU ground must be connected directly to the negative battery post.
- For proper system operation, the heater control valve must be connected to the ECU.



www.vintageair.com

Engine Compartment Disassembly

NOTE: Before starting the installation, check the function of the vehicle (horn, lights, etc.) for proper operation, and study the instructions, illustrations, photos & diagrams. Retain OEM bolts, washers and nuts (unless otherwise indicated), as some hardware will be reused. When the installation is complete, ensure all holes through the firewall are sealed to prevent water intrusion. Also, be sure the windshield wiper escutcheon is sealed as well. Any water damage to the evaporator system may void the warranty. Vintage Air recommends the removal of the hood for easier installation. Before removing the hood, mark where the hood and hinge meet with a pencil (See Photo 1, below). This will help during reassembly.

Perform the following:

1. Remove the hood by removing (4) hood hinge bolts (retain) (See Photo 2, below).
2. Remove the passenger-side hood hinge by removing (4) bolts ((2) bolts from under the dash inside the passenger compartment and (2) in the engine compartment) (See Photos 3 and 4, below).
3. Disconnect and remove the battery.
4. Remove the battery tray by removing (4) bolts (See Photos 5 and 6, below).
5. Remove the air cleaner (See Photo 7, below).
6. Drain the radiator, then remove the upper and lower hoses.

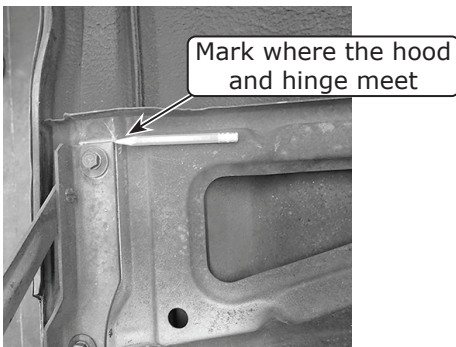
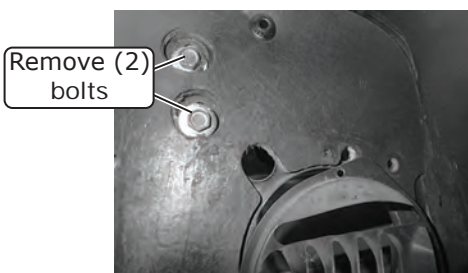

Photo 1

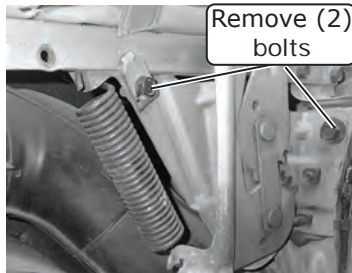

Photo 2



Under Dash,
Passenger
Compartment

Photo 3



Engine
Compartment

Photo 4

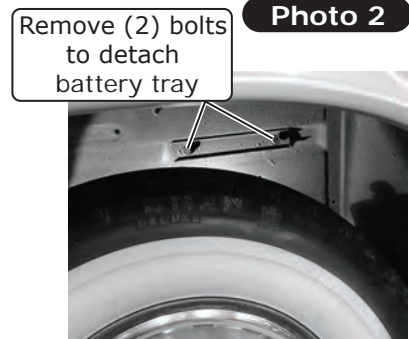

Photo 5

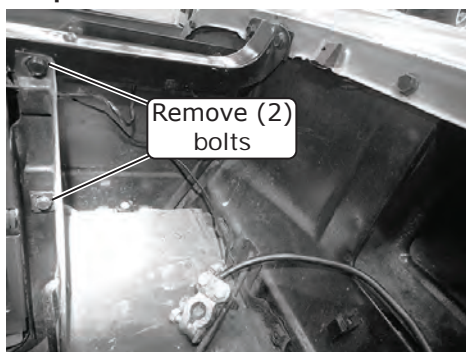

Photo 6

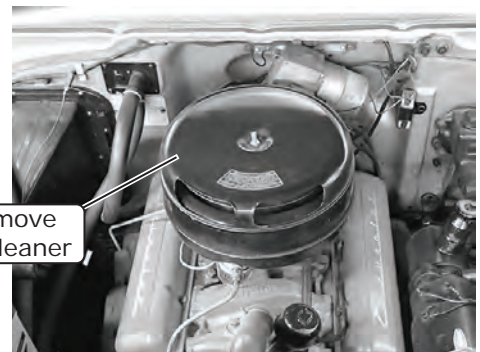

Photo 7



www.vintageair.com

Engine Compartment Disassembly (Cont.)

7. Remove the OEM heater hose clamps and hoses (See Photos 8 and 9, below).
8. Disconnect the transmission cooling lines at the bottom of the radiator (See Photo 10, below).
9. Remove the (3) bolts on each side of the radiator, then lift the radiator out (See Photo 11, below).
10. Remove the OEM blower assembly by removing (2) bolts and the reinforcement bracket on the inner fender (See Photo 12, below), then (2) bolts in the engine compartment (See Photo 13, below).
11. Remove the (4) screws on the OEM heater control water valve (See Photo 14, below), then remove the blower assembly by pulling up the retaining brackets. **NOTE: Save the retaining brackets.**
12. Remove the OEM heater core (See Photo 15, below).
13. Remove the heater control water valve and cable by removing the screw (discard) (See Photo 16, below).
14. Locate the supplied OEM heater control water valve cover, then apply seam sealer or silicone to the mating surface. Install the cover and secure it using (4) #8 x 1/2" screws (See Photo 17, below).

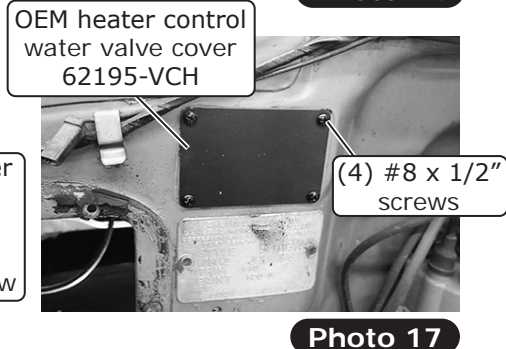
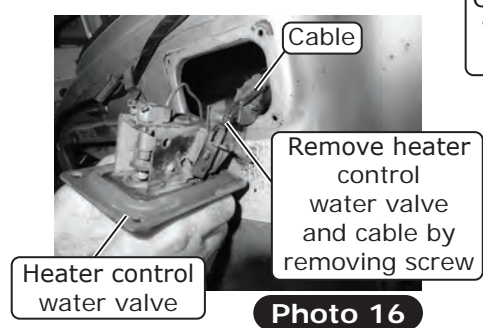
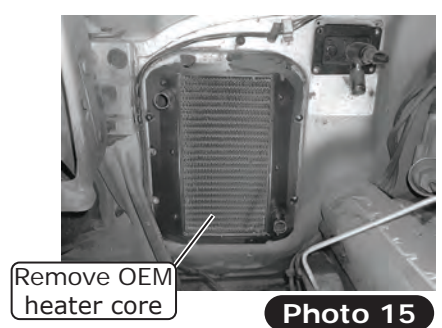
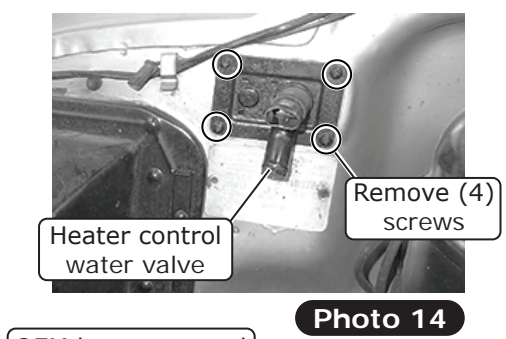
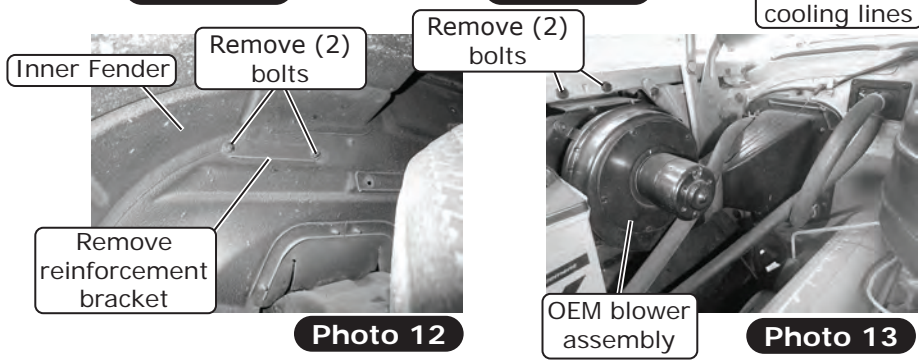
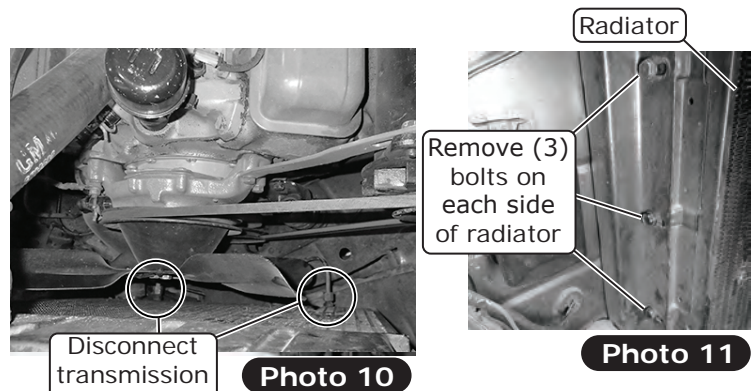
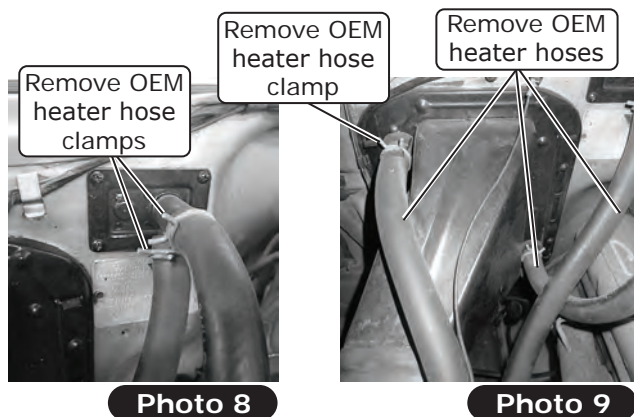



www.vintageair.com

Passenger Compartment Disassembly

Perform the following:

1. Remove the control panel bezel by removing (4) screws (See Photo 1, below).
2. Remove the OEM control panel assembly (retain), and disconnect the cables (discard) (See Photo 2, below).
NOTE: Refer to the control panel conversion kit instructions for installation of controls.
3. Remove the glove box door by removing (3) screws as shown in Photo 3, below.
4. Remove the glove box by removing (5) screws as shown in Photo 4, below.
5. Remove the clock from the dash by detaching the light sockets and hardware from behind the dash (See Photo 5, below).

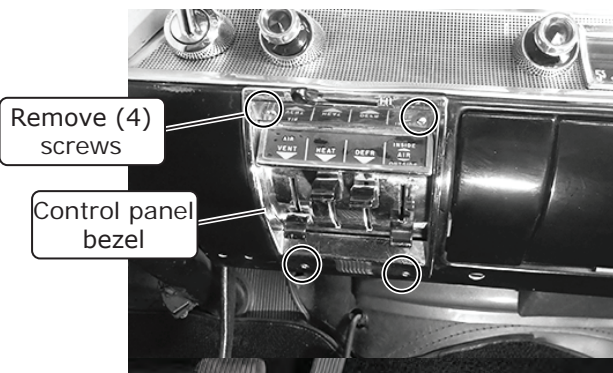

Photo 1

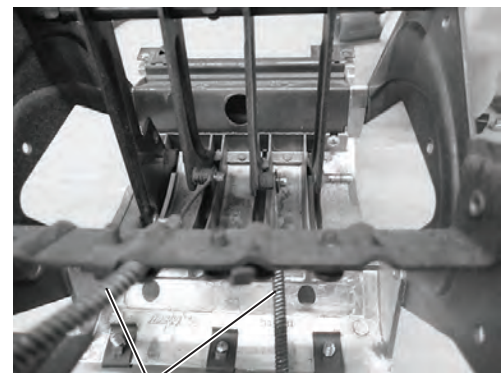

Photo 2

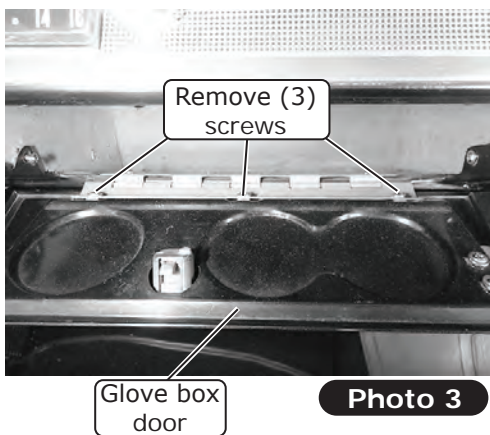

Photo 3

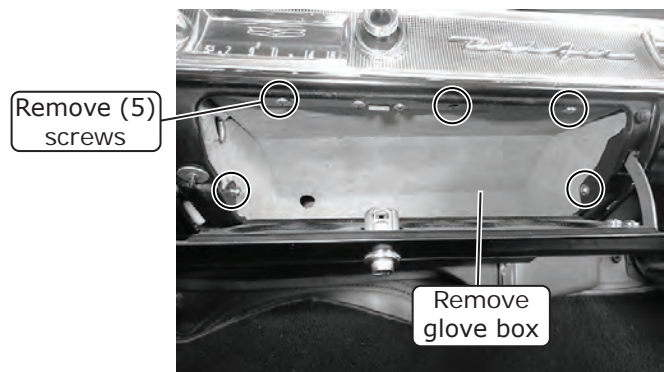

Photo 4

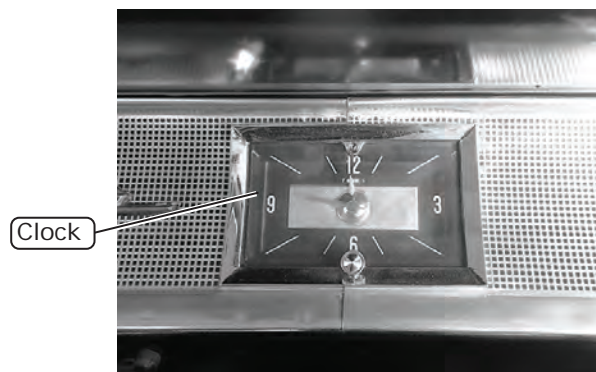

Photo 5



www.vintageair.com

Passenger Compartment Disassembly (Cont.)

6. To remove the heater assembly and the OEM defrost duct, perform the following:
- A. Remove the screw behind the distributor in the engine compartment. **NOTE: To gain access to the screw, removal of the distributor cap may be required (See Photo 6, below).**
 - B. Remove the (2) screws on the outside of the blower housing opening (See Photo 7, below).
 - C. In the passenger compartment, under the dash, remove the (4) screws on the heater assembly cover (See Photo 8, below).
 - D. Remove the (2) screws securing the OEM defrost duct to the dash (See Photo 9, below). Disconnect the wiring, and remove the screw securing the cable to the defrost duct (See Photo 10, below).
 - E. Remove the (3) screws securing the fresh air vent cover to the firewall (See Photo 11, below).

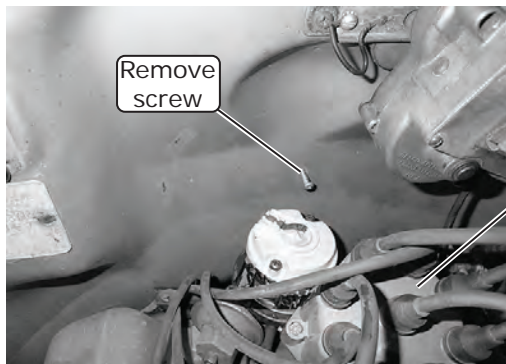

Engine Compartment View

Photo 6

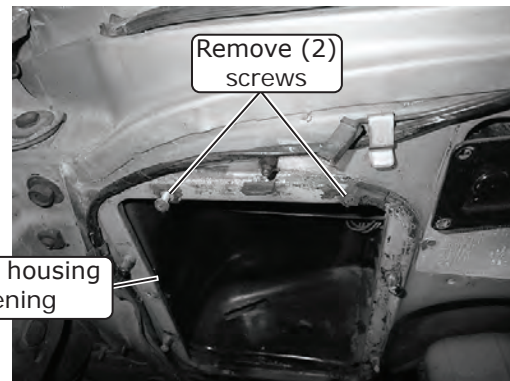

Engine Compartment View

Photo 7

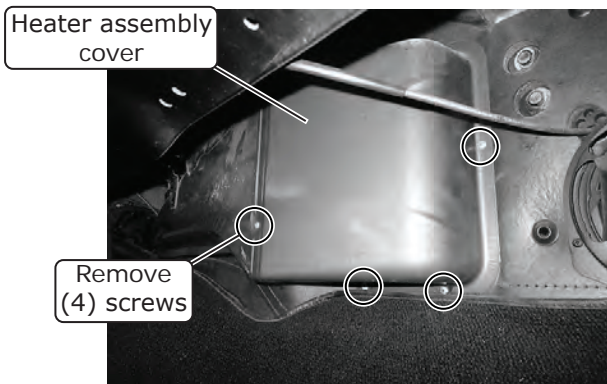

Photo 8

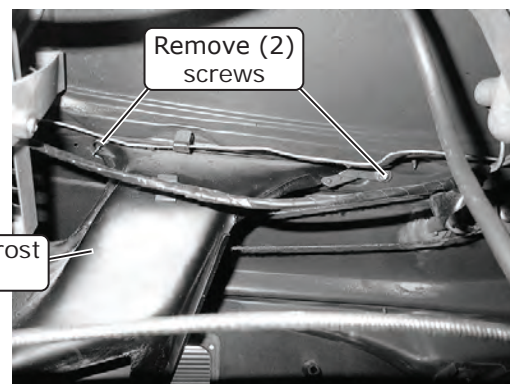

Photo 9

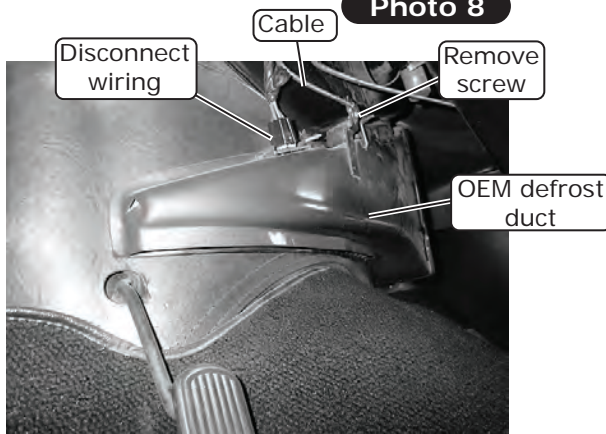

Photo 10

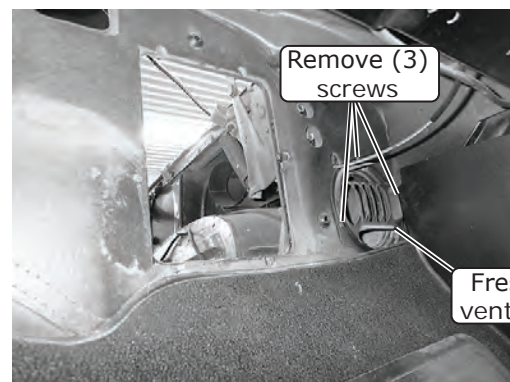

Photo 11



www.vintageair.com

Passenger Compartment Disassembly (Final)

7. To remove the OEM fresh air vent tube, perform the following:

- A. Remove the fresh air vent tube in the passenger compartment by removing the (3) vent tube bolts (See Photo 12, below), the bolt under the passenger-side fender directly above the wheel, and the cable grommet from the firewall (See Photos 12 and 13, below).
- B. Remove the fresh air vent tube from the passenger-side fender, and remove the cable by removing the screw and clamp (See Photos 14 and 15, below).

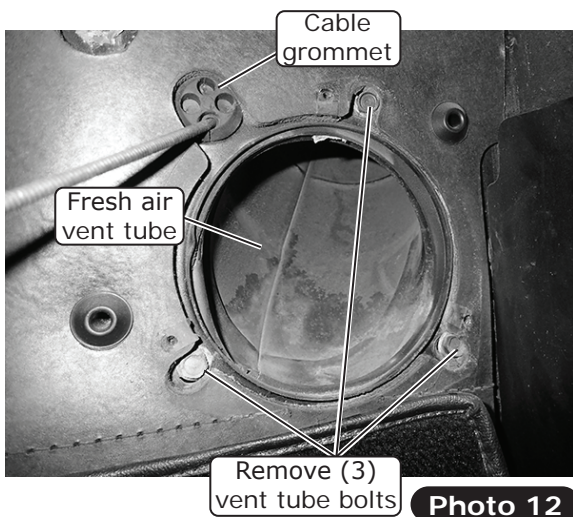

Photo 12



Passenger-Side
Fender View

Photo 13



Photo 14

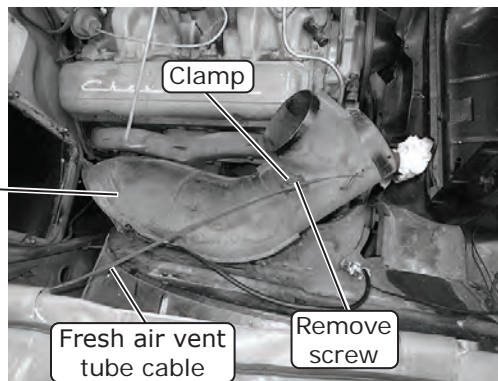

Photo 15



www.vintageair.com

Lubricating O-rings



#6 O-ring



#8 O-ring



#10 O-ring

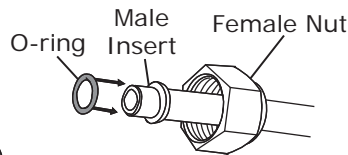

For a proper seal of fittings: Install supplied O-rings as shown and lubricate with refrigerant oil.

Refrigerant Oil for O-rings

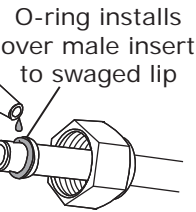

O-ring installs over male insert to swaged lip

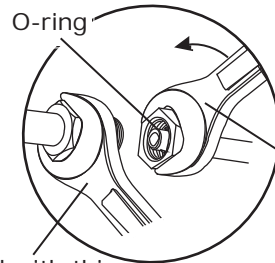

Twist with this wrench

Hold with this wrench

NOTE: Standard torque specifications:

#6: 11 to 13 ft-lb.

#8: 15 to 20 ft-lb.

#10: 21 to 27 ft-lb.

Properly Seated O-ring Land

When installing a hardline or A/C hose fitting onto the evaporator module, ensure the O-ring land is seated properly (See Photo 1, below). An improperly seated O-ring land (See Photo 2, below) can cause a leak. To properly install the fitting, slide the hardline or A/C hose nut back to expose the O-ring land and seat it onto the evaporator module fitting. Then, slide the hardline or A/C hose nut forward and thread it onto the evaporator module fitting, ensuring the O-ring land does not move or lift.

Properly Seated O-ring Land



Photo 1

Improperly Seated O-ring Land

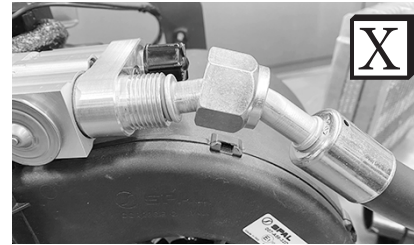

Photo 2

NOTE: Photos shown are for reference only. Fittings may vary depending on kit received.



www.vintageair.com

Evaporator Preparation

Perform the following on a workbench:

1. Remove the plastic caps and rubber inserts (See Photo 1, below). Install the upper and lower heater hardlines onto the evaporator module using (2) properly lubricated #10 O-rings (See Lubricating O-rings, Page 11) (See Photos 2, 3 and 4, below). **NOTE: Use back up wrenches on these connections.**
2. Install a 1/2" plastic plug into the back mounting provision (See Photos 5 and 6, below). **NOTE: This mounting location will not be used for this application.**

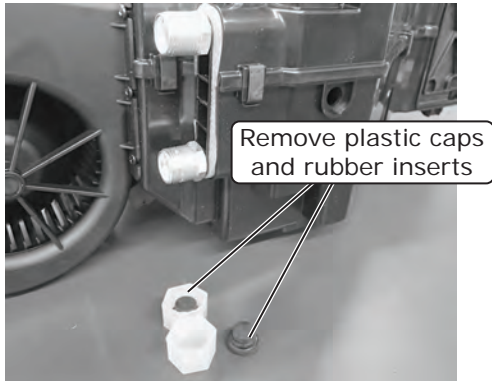

Photo 1

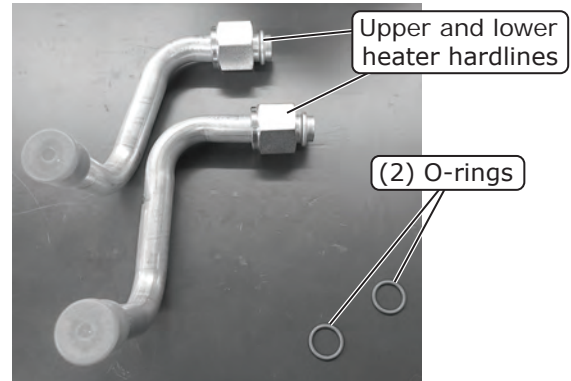

Photo 2

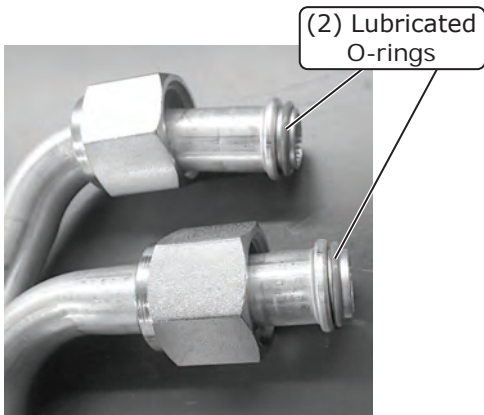

Photo 3

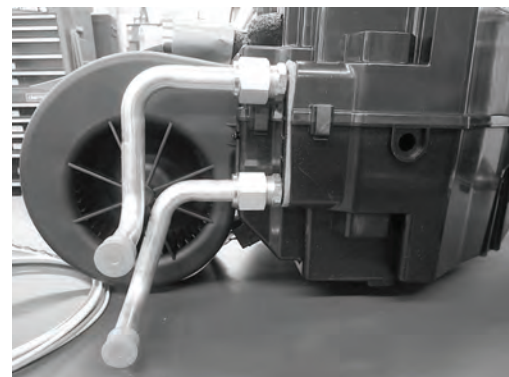

Photo 4

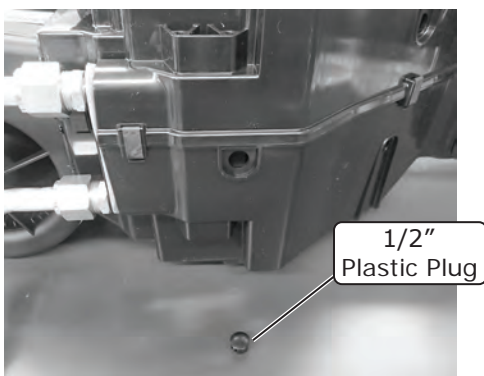

Photo 5



Photo 6



www.vintageair.com

Evaporator Preparation (Cont.)

3. Install (2) 1/4-20 well nuts into the evaporator module as shown in Photos 7 and 8, below.
4. Using (4) #10 x 5/8" screws and (2) 1/4-20 x 1" bolts, secure the evaporator firewall bracket to the evaporator unit (See Photos 9 and 10, below).
5. Install a 1/4-20 U-nut onto the firewall bracket (See Photo 11, below).
6. Install a 1/4-20 x 1 1/2" full-length stud into the firewall bracket U-nut until 1/2" is visible (See Photo 12, below).

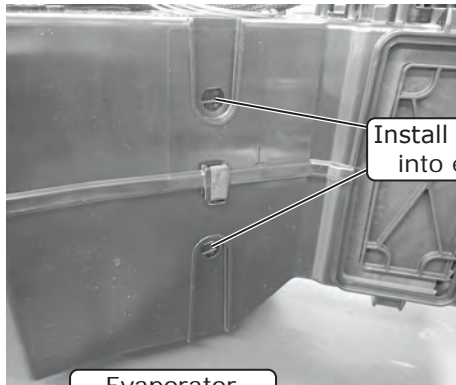

Install (2) 1/4-20 well nuts into evaporator module

Evaporator Firewall Bracket 646013

Photo 7



Photo 8

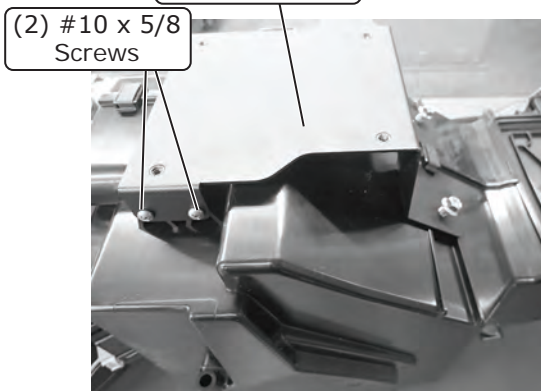

(2) #10 x 5/8 Screws

Evaporator Firewall Bracket 646013

Photo 9

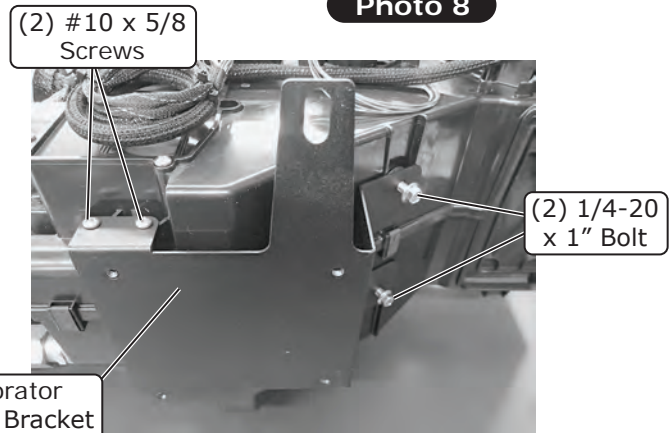

(2) #10 x 5/8 Screws

(2) 1/4-20 x 1" Bolt

Photo 10

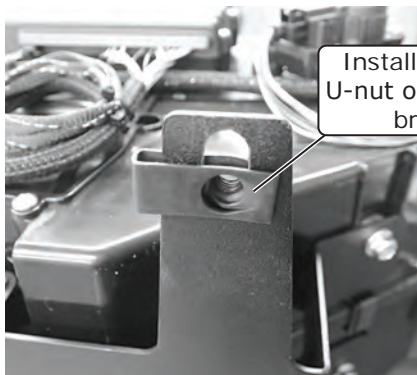

Install a 1/4-20 U-nut onto firewall bracket

Photo 11

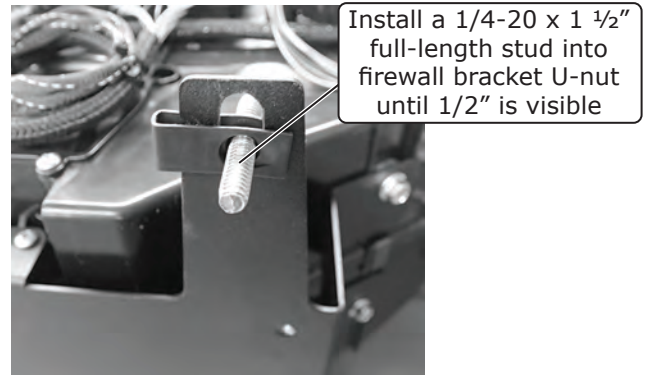

Install a 1/4-20 x 1 1/2" full-length stud into firewall bracket U-nut until 1/2" is visible

Photo 12



www.vintageair.com

Evaporator Preparation (Final)

- Using (4) spring clips ((2) per side), install the center vent plenum adapter onto the evaporator module (See Photos 13, 14 and 15, below).
- Using (2) spring clips, install the floor plenum onto the evaporator module (See Photo 16, below).

Center Vent
Plenum Adapter
628125

(4) Spring
Clips

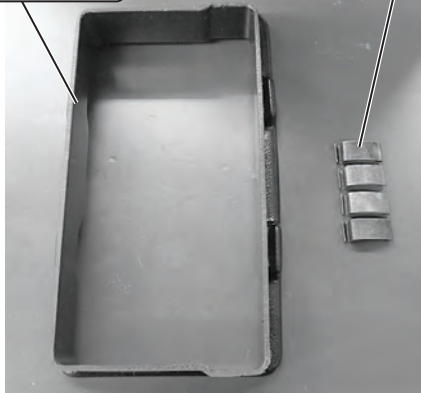

Photo 13

Using (2) spring
clips per side,
install center
plenum adapter

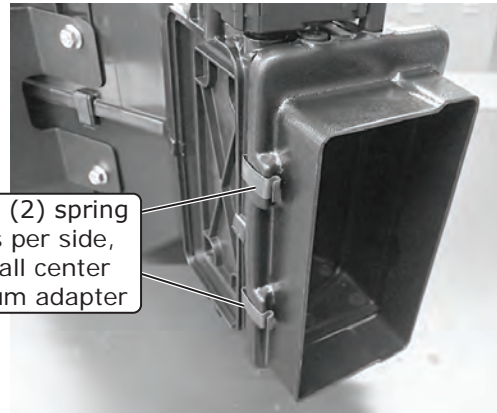

Photo 14



Spring Clip
Installed

Photo 15

Floor
Plenum
625338

Using (2) spring
clips, install
floor plenum

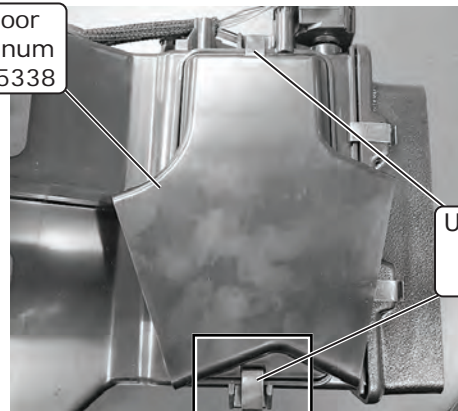

Photo 16





www.vintageair.com

Firewall Modification for Ring Bracket

1. Install (3) 1/4-20 full-length studs into the ring bracket as shown in Photos 1 and 2, below, and temporarily install it into the fresh air opening on the firewall (See Photo 3, below).
2. Using the ring bracket as a template, mark the sections of the firewall to be removed (See Photo 4, below). Remove the ring bracket at this time.
3. Remove the two marked sections (See Photo 5, below).

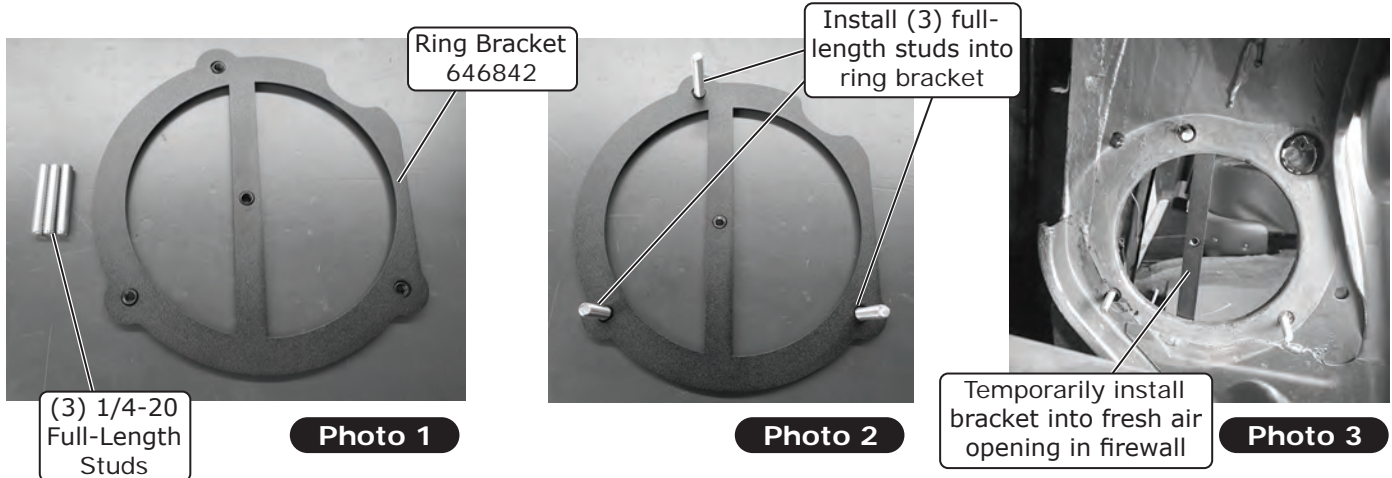

Using ring bracket as template mark sections of firewall to be removed

Photo 4

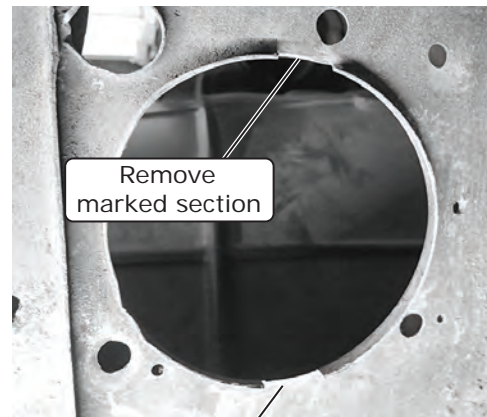

Remove marked section

Photo 5



www.vintageair.com

Firewall Insulation

NOTE: Clean the area of the inner dash to the right of the radio, as this is the area where the ECU will be mounted. For proper system operation, Vintage Air recommends using heat-blocking insulation in the area around the evaporator unit (firewall, inner cowl and kick panel). Due to the tight clearance for the evaporator unit between the firewall and dash, Vintage Air recommends an insulation thickness of no more than 1/4".

1. Pull back the carpet and padding as shown in Photo 1, below.
2. Remove the OEM insulation (See Photo 1, below), then clean the surface where the new insulation will be installed (See Photo 2, below).
3. Install the insulation pieces using spray adhesive, then cover the seams using duct tape (See Photo 3, below). Apply insulation to the firewall cover (See Photo 4, below).

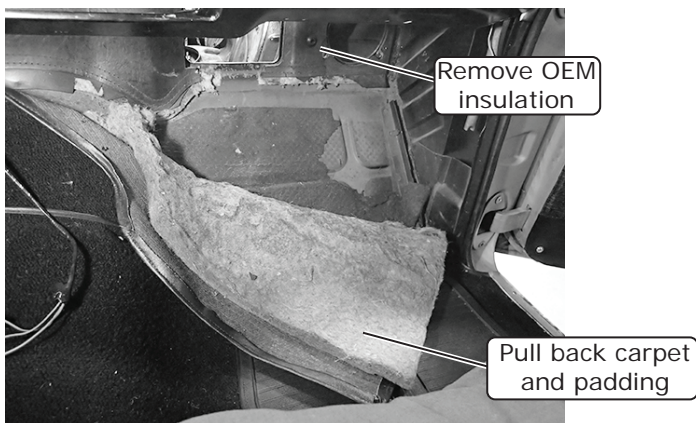

Photo 1



Photo 2



Photo 3

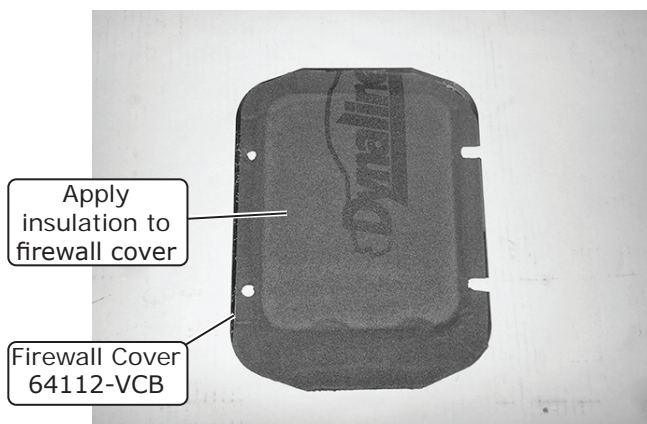

Photo 4



www.vintageair.com

Ring Bracket, Firewall Rubber Boot and Fresh Air Plate Installation

1. Install the ring bracket in the passenger compartment and from the engine compartment, install the firewall rubber boot and fresh air plate (See Photos 1 and 2, below).
2. Secure all (3) parts using a 1/4-20 x 3/4" bolt in the center mounting hole (See Photo 3, below).
3. Replace all (3) 1/4-20 studs with (3) 1/4-20 x 3/4" bolts (See Photo 4, below).
4. Tighten all hardware.

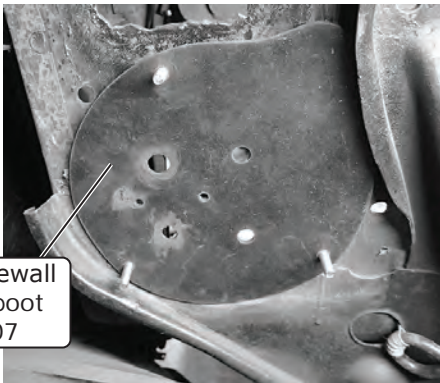

Engine Compartment View **Photo 1**

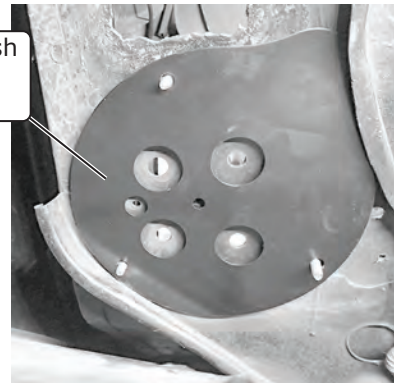

Engine Compartment View **Photo 2**

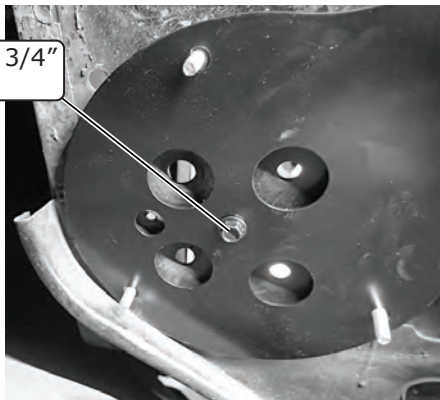

Engine Compartment View **Photo 3**

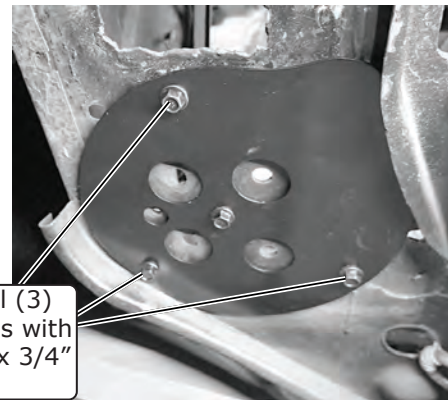

Engine Compartment View **Photo 4**

Hood Hinge Reinstallation

1. Reinstall the passenger-side hood hinge using the (4) OEM bolts (See Photo 1, below). **NOTE: Passenger-side hood hinge must be installed at this time. Once the unit is installed, the hood hinge will not have the clearance to be reinstalled.**



Photo 1



www.vintageair.com

Defrost Duct Installation

NOTE: The passenger-side defrost duct has a notch for the OEM wire clip (See Photo 1, below).

1. Locate the driver- and passenger-side defrost ducts. Attach a 12" length of 2 1/2" duct hose to the passenger side-defrost duct and a 20" length of 2 1/2" duct hose to the driver-side defrost duct (See Photo 2, below).
2. Install the (2) defrost ducts onto the OEM defrost duct mounting flanges under the dash, then loosely secure them using (2) #8 x 1/2" wide head screws on each duct (See Photos 3, 4 & 5, below). Adjust the defrost duct as needed to capture the defrost opening and to avoid interference with the windshield wiper cables, then tighten the hardware.

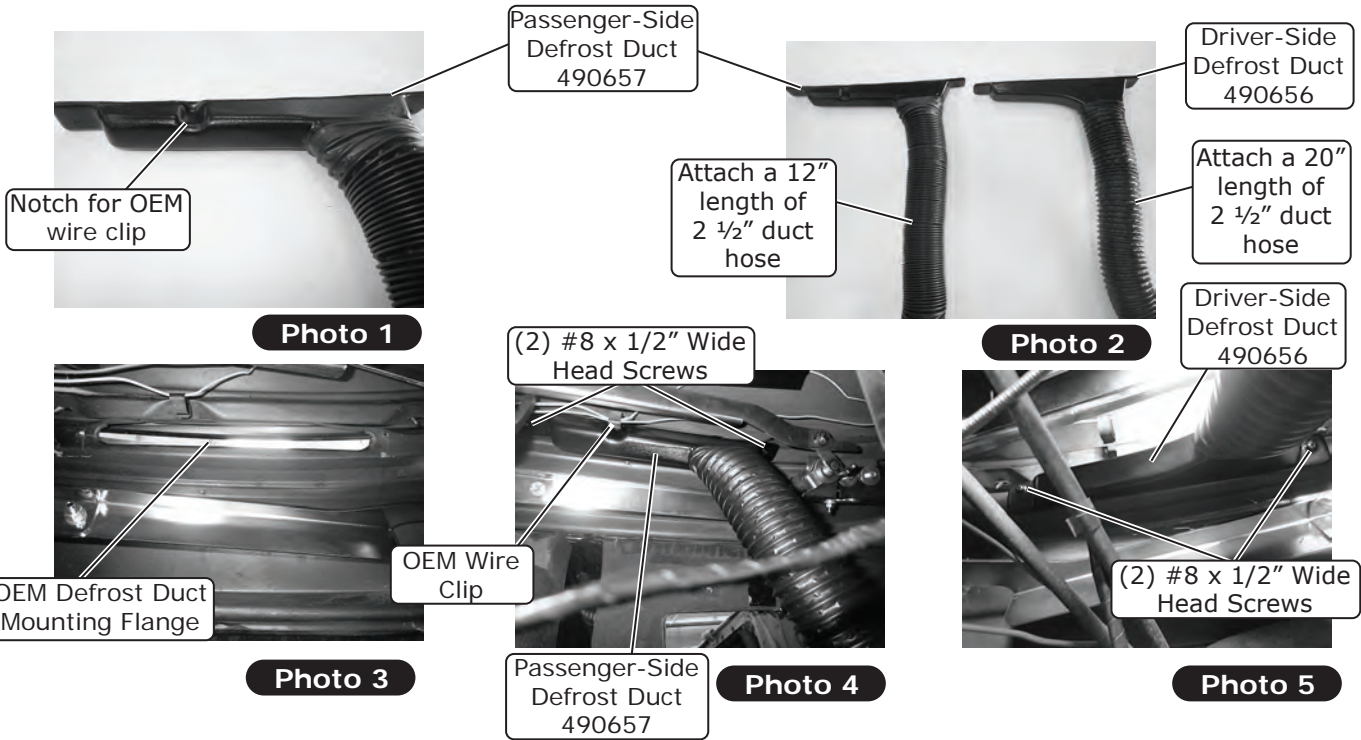

Wiring Installation

1. Route the heater control valve plug (red, white and blue wires) through the rubber boot into the engine compartment (See Photos 1 and 2, below).
2. Select a mounting location for the main relay and the ground eyelet, then secure them using the supplied self-tapping screws (See Photo 3, below).

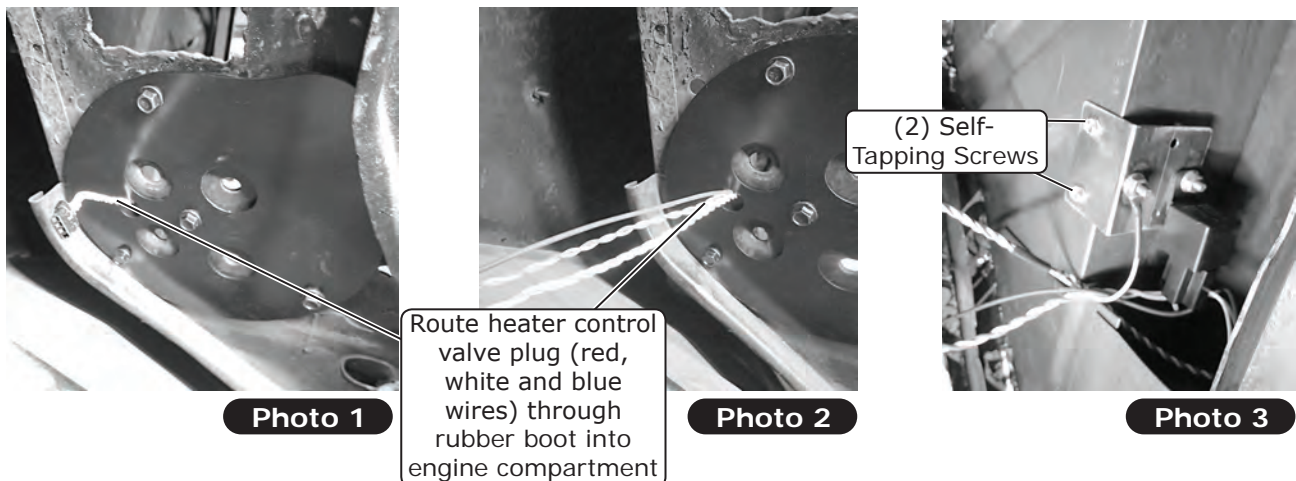



www.vintageair.com

A/C Hose Routing

1. Route the 45° fittings of the #10 and #6 A/C hoses through the fresh air plate and firewall rubber boot, then into the passenger compartment (See Photos 1 and 2, below).

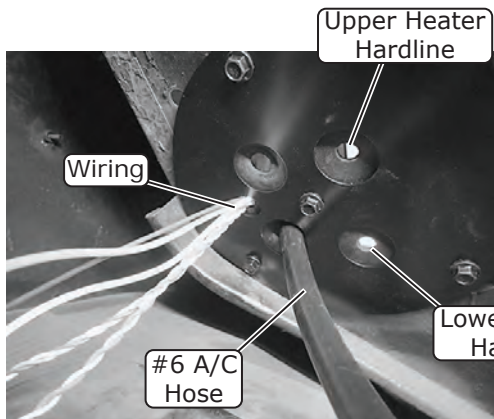

Photo 1

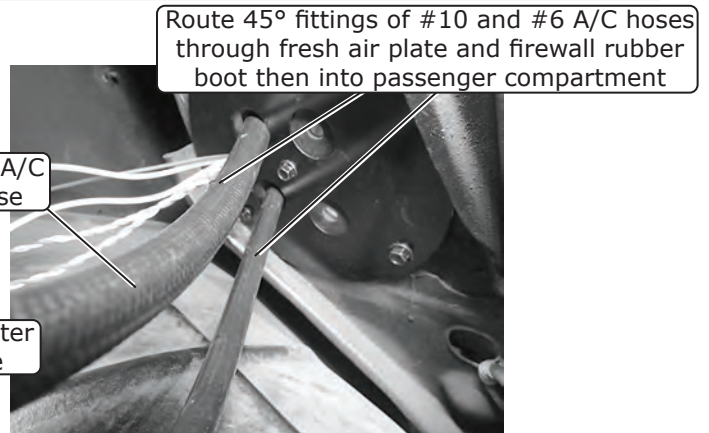

Photo 2

Evaporator Installation

NOTE: To ensure a watertight seal between the passenger compartment and the vehicle exterior, for all bolts passing through the firewall, Vintage Air recommends coating the threads with silicone prior to installation.

1. Place the evaporator module on the passenger-side floorboard.
2. Loosen the (2) screws securing the ECU to the evaporator unit (See Photo 1, below), then remove it from the top of the evaporator. Retighten the screws.
3. Apply (2) Velcro strips to the back of the ECU (See Photo 2, below).
4. Route the heavy gauge orange and white wires into the engine compartment through the firewall rubber boot and fresh air plate (See Photos 3 and 4, below).

Loosen (2) screws securing ECU to evaporator unit and remove ECU

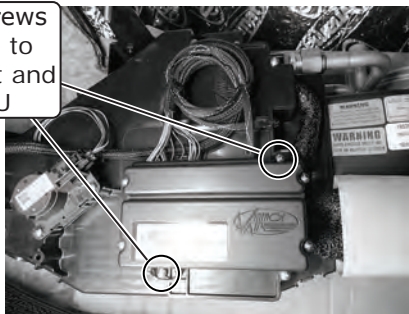
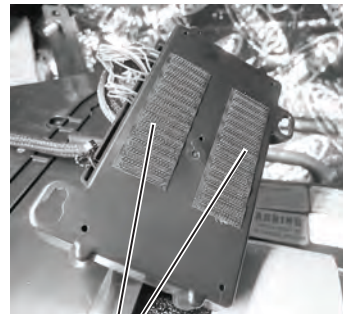

Photo 1



Apply (2) Velcro strips to back of ECU

Photo 2



Route heavy gauge orange and white wires into engine compartment through firewall rubber boot and fresh air plate

Photo 3

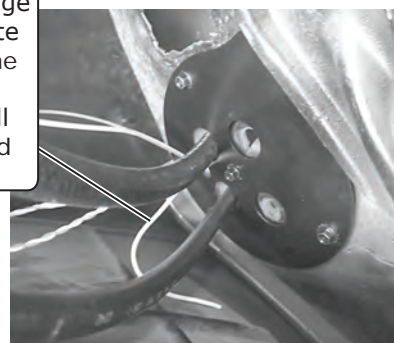

Photo 4



www.vintageair.com

Evaporator Installation (Cont.)

5. Install the #6 and #10 O-rings onto the A/C hose 45° fittings (See Photo 5, below).
6. Remove the plastic caps and rubber inserts from the block fitting adapter (See Photo 6, below).
7. Properly lubricate the #6 O-ring (See Lubricating O-rings, Page 11), and install the #6 45° fitting onto the block fitting adapter (See Photo 7, below).
8. Properly lubricate the #10 O-ring (See Lubricating O-rings, Page 11), and install the #10 45° fitting onto the block fitting adapter, then cover with the supplied press tape (See Photo 8, below).
9. Raise the evaporator module into position looking through the clock opening, make sure the 1/4-20 x 1 1/2" stud goes through the upper mounting bolt hole on the firewall (See Photo 9, below). From the engine compartment, install a washer and 1/4-20 nut with star washer onto the full-length stud to temporarily secure the evaporator module in place (See Photo 9, below). **NOTE: A 2" x 4" board can be used to keep the evaporator module in place while the nut is being installed (See Photo 10, below).**
10. Install the firewall support bracket over the OEM cover mounting pins. **NOTE: Temporarily install the OEM firewall cover retainers to hold the firewall bracket in place (See Photo 11, below).**

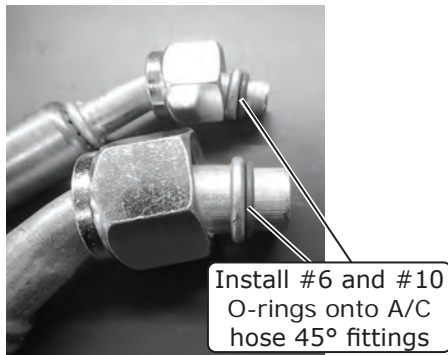

Photo 5

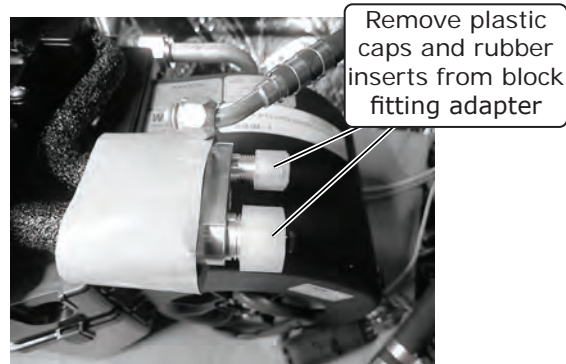

Photo 6

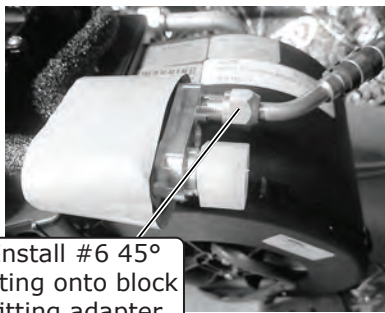

Photo 7

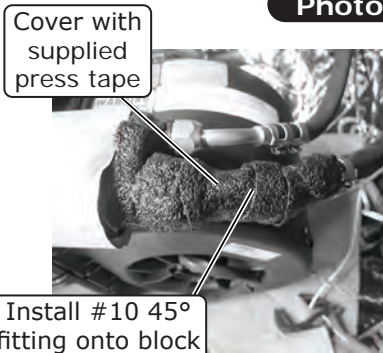

Photo 8

Install a washer and 1/4-20 nut with star washer onto 1/4-20 x 1 1/2" stud

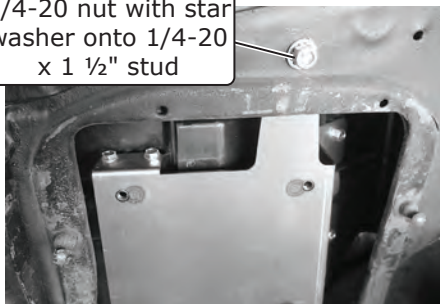

Photo 9

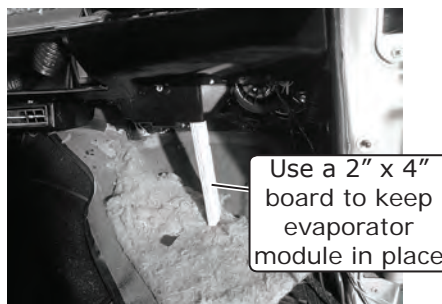

Photo 10

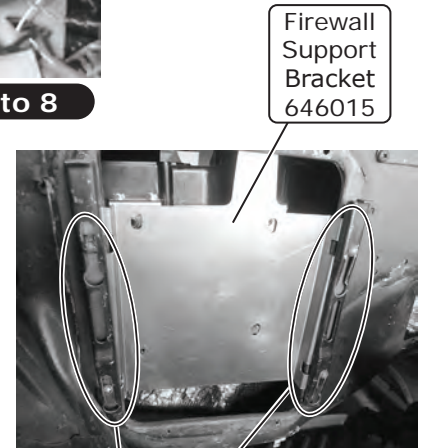

Photo 11

Temporarily install OEM firewall cover retainers to hold bracket in place



www.vintageair.com

Evaporator Installation (Final)

11. Loosely secure the evaporator firewall bracket to the support bracket using (4) 1/4-20 x 1/2" hex bolts (See Photo 12, below).
12. Install (2) well nuts into the evaporator module mounting provisions for the dash bracket (See Photo 13, below).
13. Loosely install the evaporator dash bracket onto the evaporator module using (2) 1/4-20 x 1" hex flange bolts (See Photo 14, below), then secure the evaporator dash bracket to the underdash lip using a 1/4-20 x 3/4" pan head screw and a 1/4-20 nut with star washer (See Photo 15, below). **NOTE: Do not fully tighten the bolts at this time. Some adjustment may be needed when leveling the evaporator unit.**
14. Replace the upper 1/4-20 x 1 1/2" stud on the firewall with a 1/4-20 x 3/4" hex flange bolt and a 1/4" sleeve washer (See Photo 16, below).
15. Install the defrost hoses onto the defrost plenum then install it onto the evaporator module using (2) spring clips (See Photo 17, below).
16. Insert the center vent plenum assembly into the plenum adapter and loosely secure it to the under dash using the supplied bracket and hardware (See Photo 18, below).
17. Verify that the evaporator unit is level, then tighten all of the mounting bolts.
18. If needed, there are (3) #6 x 1/2" screws included in the installation kit. These screws can be used for extra support for the center plenum (See Photo 20, below).
19. Remove the OEM firewall cover retainers.
20. Apply seam sealer or silicone to the mating surface of the firewall cover, then install it using the OEM retainers (See Photo 19, below).

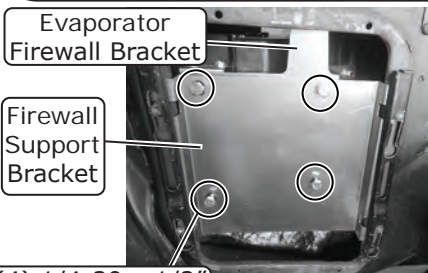

(4) 1/4-20 x 1/2" Hex Bolts

Photo 12



Photo 13

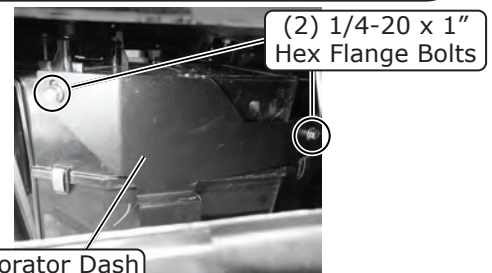

Evaporator Dash Bracket 646014

Photo 14

Secure dash bracket to under-dash lip using a 1/4-20 x 3/4" pan head screw and 1/4-20 nut with star washer

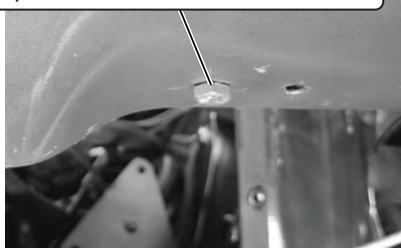

Photo 15

1/4-20 x 3/4" Hex Flange Bolt



Photo 16

1/4" Sleeve Washer

Install defrost hoses onto defrost plenum

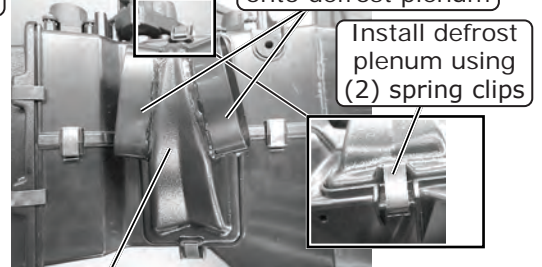

Defrost Plenum 625321

Photo 17

Loosely secure plenum to underdash using supplied bracket and hardware

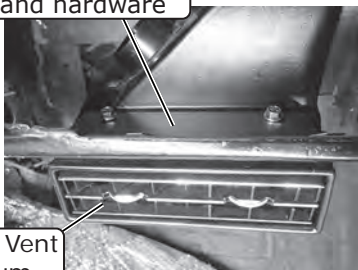

Center Vent Plenum 628130

Photo 18

Install firewall cover using OEM retainers

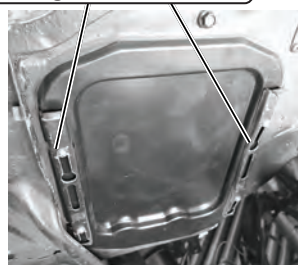

Photo 19

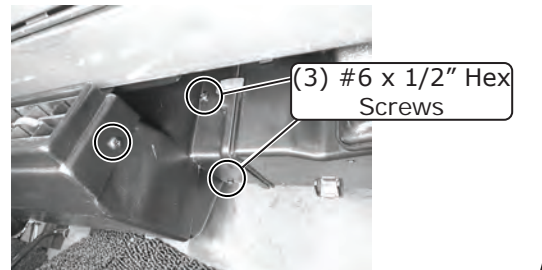

Photo 20



www.vintageair.com

Control Panel Installation

1. Reinstall the converted control panel using OEM hardware (See Photo 1, below).

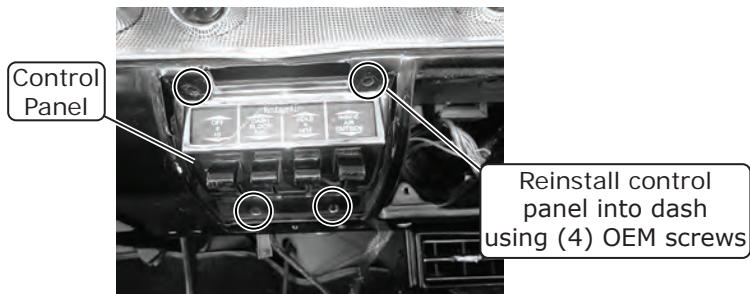

Photo 1

ECU Installation

1. Plug the main wiring harness black connector into the ECU module (See Photo 1, below).
2. Plug the control panel connector into the ECU module (See Photo 2, below).
3. Apply (2) strips of Velcro and mount the ECU to the right of the radio on the inner dash (See Photo 3, below).
NOTE: Ensure the area is clean and free of debris before applying the Velcro.

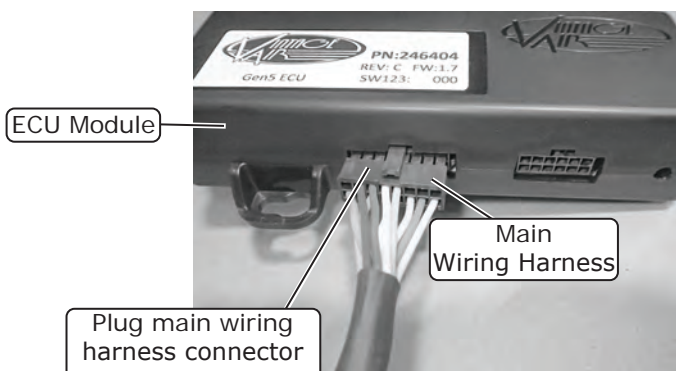

Photo 1

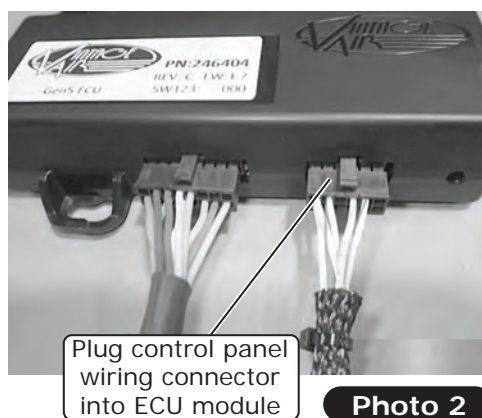

Photo 2

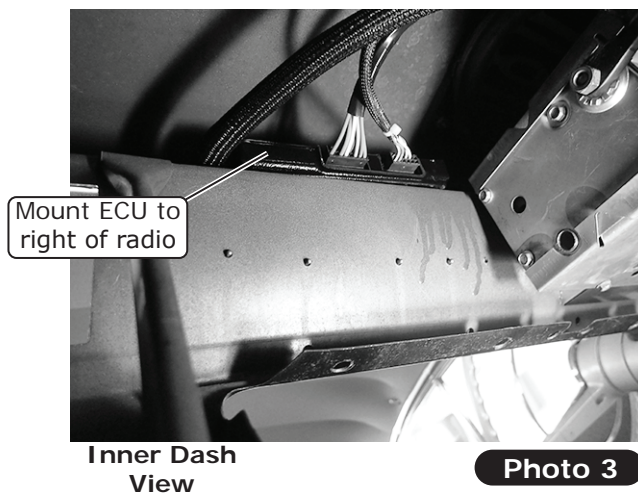

Photo 3



www.vintageair.com

Passenger Compartment Wiring

1. Route the violet power wire to a switched 12V power source on the fuse panel (See Photo 1, below).
NOTE: This requires a male fuse extension (not supplied).
2. Connect the tan wire to the factory dash lights to enable control panel backlighting (if applicable).
3. Connect the BSC wiring to the main harness (See Photo 2, below).

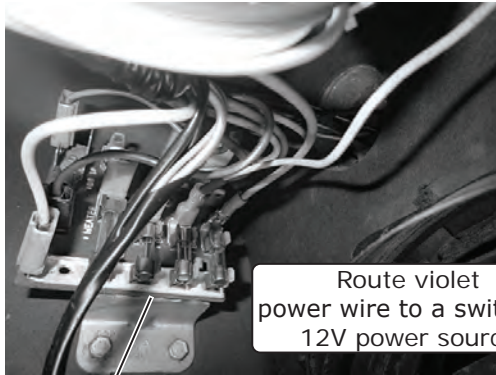

Fuse Panel

Photo 1

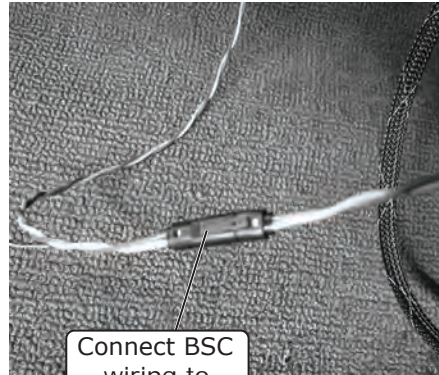

Connect BSC wiring to main harness

Photo 2

Drain Hose Installation

1. From the passenger compartment, using the firewall opening as a reference, measure down 2 3/4" from the bottom-right corner. Mark and drill a 5/8" hole through the firewall for the drain hose (See Photo 1, below).
2. Insert the drain hose through the previously drilled 5/8" hole, then attach it to the evaporator drain (See Photo 2, below). **NOTE: If the hole is covered by carpet, a 5/8" hole will need to be cut into the carpet as well.**

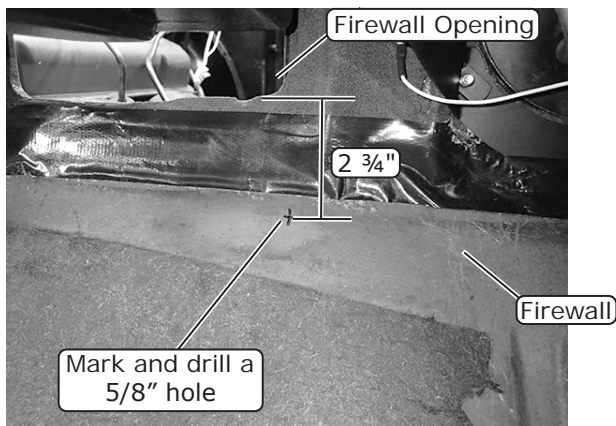

Photo 1

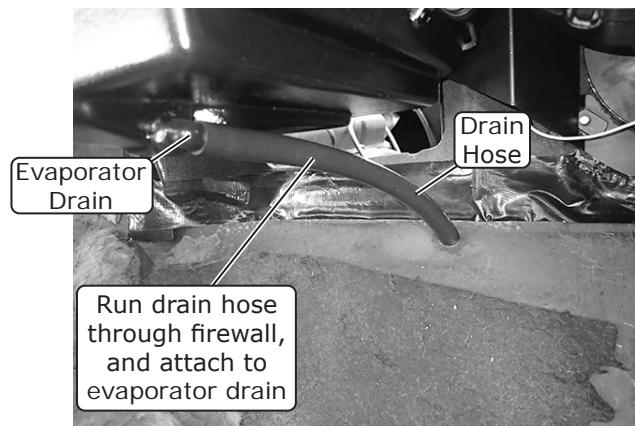

Photo 2



www.vintageair.com

Driver- and Passenger-Side Louver Installation

1. In the passenger compartment, on the passenger side at the bottom-right corner of the dash, measure $3/8"$ to the right from the center of the OEM hole. Mark and drill a $7/32"$ hole as shown in Photo 1, below.
2. On the driver side, at the bottom-left corner of the dash, measure $3/8"$ to the left from the center of the OEM hole. Mark and drill a $7/32"$ hole as shown in Photo 2, below.
3. Install a 10-24 x $1/2"$ square-neck carriage bolt into the slot on each louver bracket, then secure using a $1/8"$ push-on ring (See Photos 3 and 4, below).
4. Separate the hose adapters from the louvers (See Photo 5, below).
5. Attach the driver- and passenger-side duct hoses to the hose adapters (See Photo 6, below).

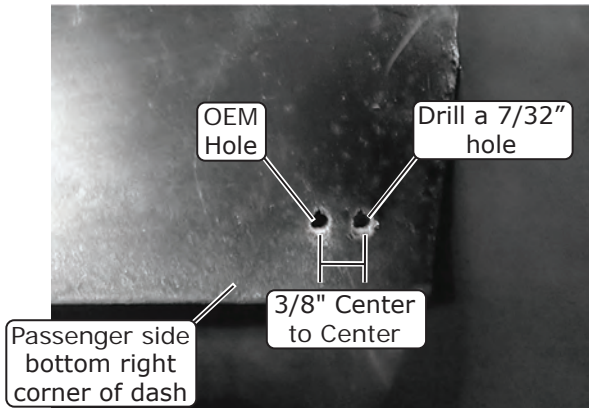

Photo 1

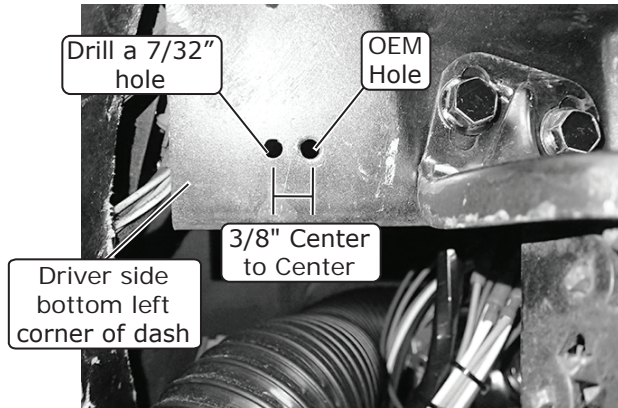

Photo 2

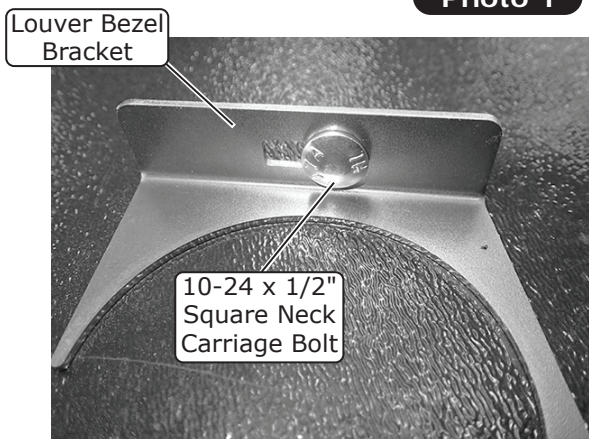

Photo 3

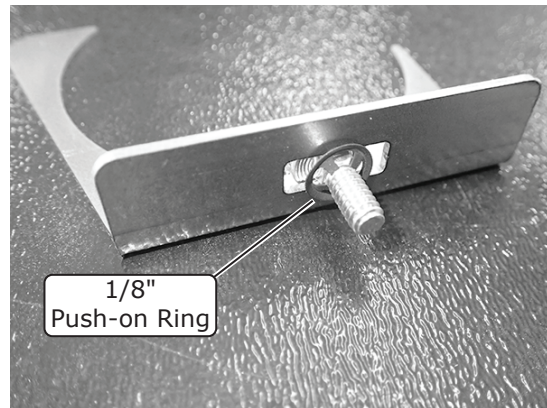

Photo 4

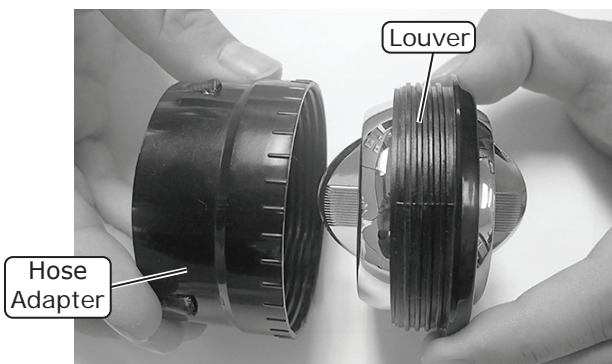

Photo 5

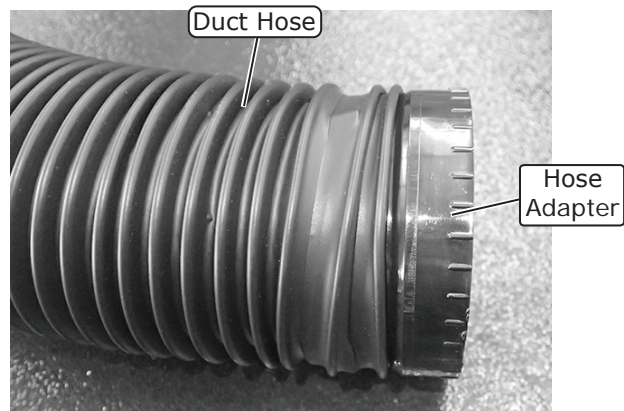

Photo 6



www.vintageair.com

Driver- and Passenger-Side Louver Installation (Cont.)

6. Install the louver bezel brackets between the louver housings and the hose adapters (See Photo 7, below). Install the louver through the louver housing and into the hose adapter, then tighten to secure the assembly together (See Photos 8, 9 and 10, below).
7. Install the driver-side louver assembly onto the previously drilled hole on the bottom of the dash, then secure it using a 10-24 nut with star washer (See Photo 11, below). **NOTE: The driver-side louver housing has a notch for easy installation next to the parking brake. This louver will use the louver mounting bracket with a smaller slot.**
8. Install the passenger-side louver assembly onto the previously drilled hole on the bottom of the dash, then secure it using a 10-24 nut with star washer (See Photo 12, below).

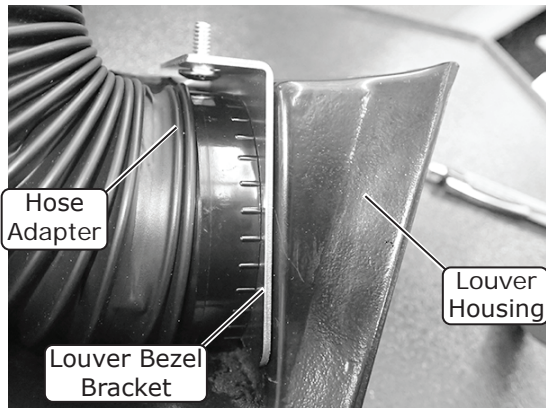

Photo 7

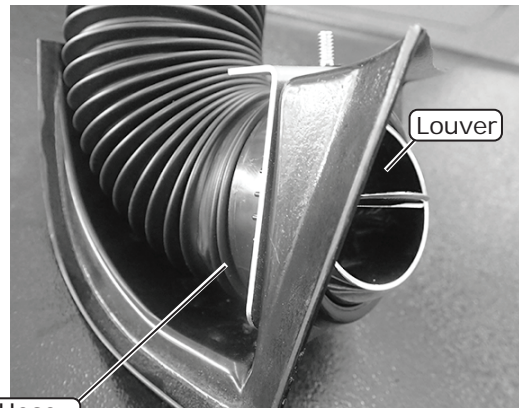

Photo 8

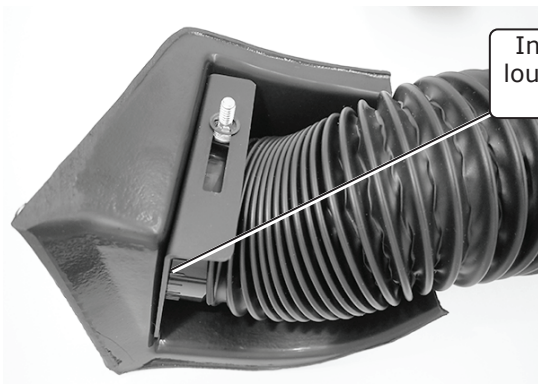

Photo 9

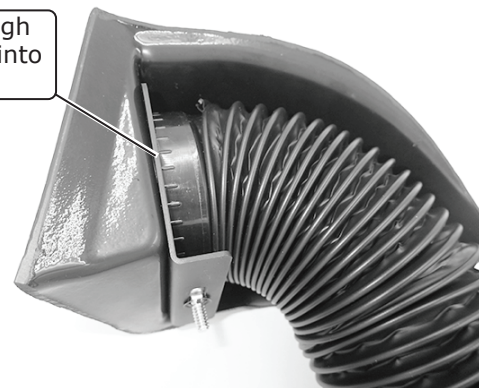

Photo 10

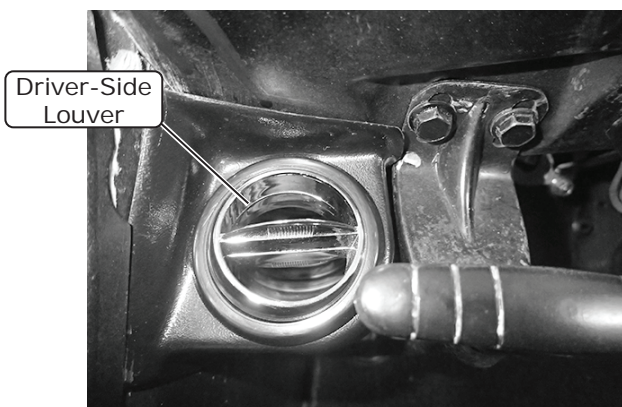

Photo 11



Photo 12



www.vintageair.com

Glove Box Installation

1. Reinstall the clock, lights and bracket.
2. Install the supplied glove box through the front of the dash. Insert the left side first, then slide the glove box to the right to the designated location. Secure using (5) OEM screws (See Photo 1, below).
3. Install the glove box door using (3) #8 x 1/2" sheet metal screws with washers (See Photo 2, below).
4. Reinstall the glove box light (See Photo 3, below).
5. Reinstall the ashtray frame using the OEM screws (See Photo 4, below).
6. Reinstall the ashtray (See Photo 5, below).



Photo 1



Photo 2

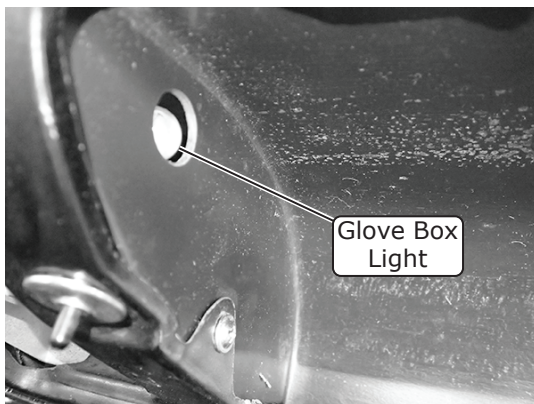

Photo 3

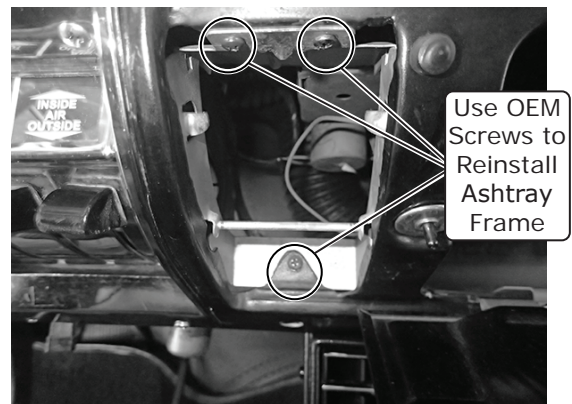

Photo 4

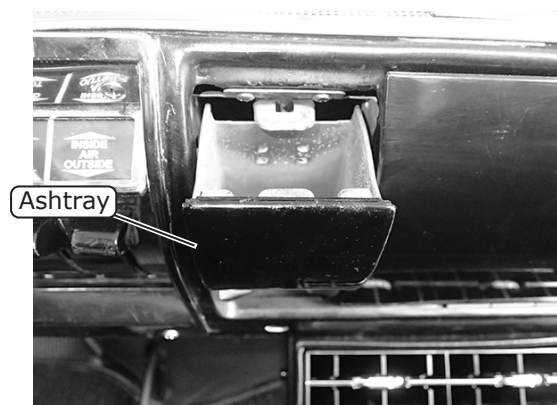

Photo 5



www.vintageair.com

Fresh Air Vent Duct Cap Installation

1. Install (3) S-clips onto the fresh air vent duct cap (See Photo 1, below).
2. Install the fresh air vent duct cap over the fresh air opening on the passenger-side inner fender (See Photo 2, below). **NOTE: The cap will protect the electronic heater control valve from water damage.**

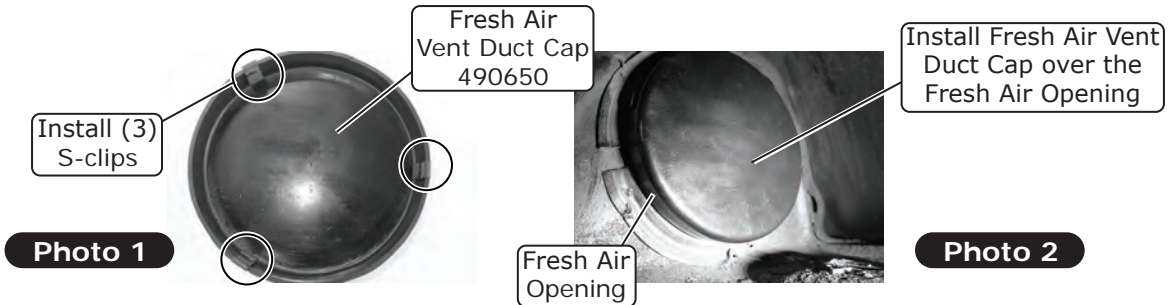

A/C Hose Installation

Standard Hose Kit:

1. Locate the #6 drier/evaporator A/C hose. Lubricate a #6 O-ring (See Lubricating O-rings, Page 11), and connect the 90° fitting to the drier (See Photo 1, below).
2. Locate the #8 condenser/compressor A/C hose. Lubricate (2) #8 O-rings (See Lubricating O-rings, Page 11), and connect the straight fitting with service port to the #8 discharge port on the compressor (See Photo 2, below). Route and connect the other straight fitting to the #8 condenser/compressor hardline (See Photo 1, below). Tighten each fitting connection as shown in Lubricating O-rings, Page 11.
3. Locate the #10 compressor/evaporator A/C hose. Lubricate a #10 O-ring (See Lubricating O-rings, Page 11), and connect the 45° fitting with service port to the compressor (See Photo 2, below).

Modified Hose Kit:

1. Refer to separate instructions included with modified hose kit.

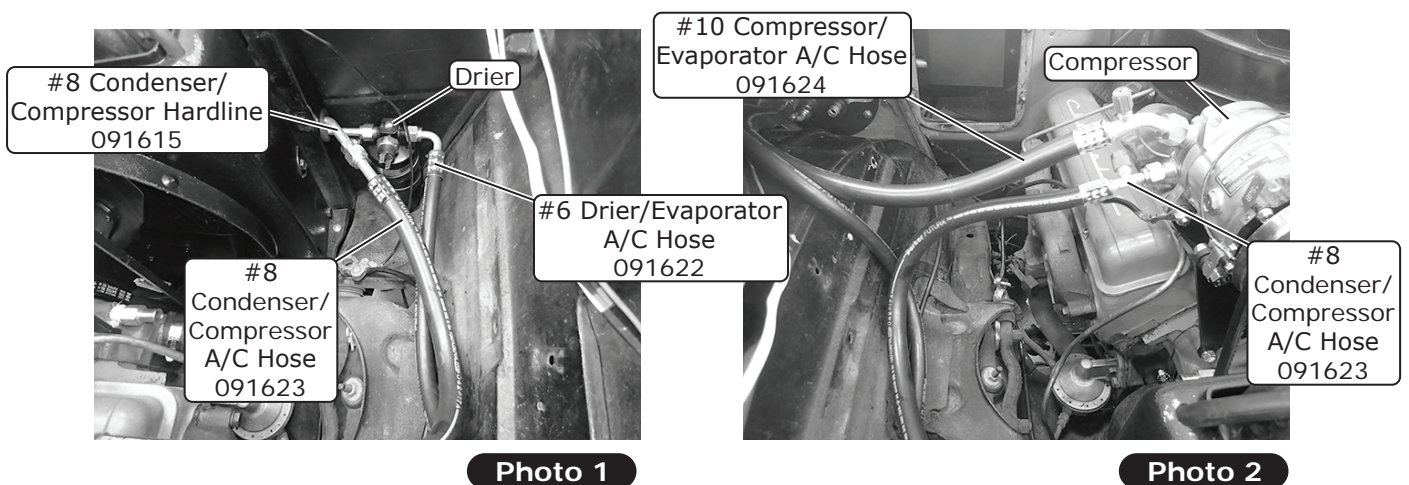



www.vintageair.com

Heater Hose & Heater Control Valve Installation

NOTE: When installing the heater control valve, ensure the flow arrow is facing toward the evaporator module. Measurements given for heater hose lengths in the instructions are recommended and may be modified for different applications.

1. Install the heater control valve support bracket onto the heater control valve using (4) #8 x 1/2" screws (See Photos 1 and 2, below)
2. Plug the heater control valve connector into the main wiring harness (See Photo 3, below).
3. Attach a 14" length of 5/8" heater hose to the heater control valve (See Photo 4, below), then attach the other end to the upper heater hardline on the evaporator unit. Secure both ends with hose clamps.
4. Secure the heater control valve assembly onto the first OEM hole closest to the hood hinge using a 1/4-20 x 3/4" pan head screw (See Photo 5, below).
5. Route the other end of the heater control valve heater hose to the intake coolant port (See Figure 1, below). Secure it with a hose clamp.
6. Route a length of heater hose to the lower heater hardline on the evaporator unit. Route the other end to the water pump coolant port (See Figure 1, below). Secure both ends with hose clamps.

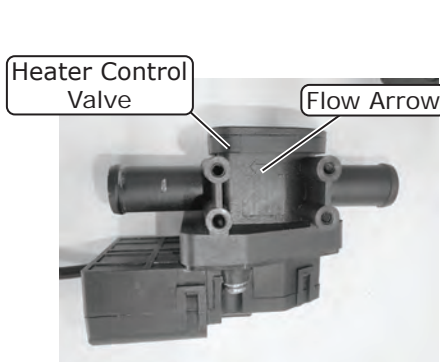

Photo 1

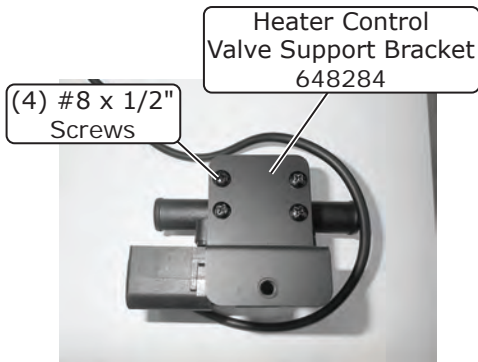

Photo 2

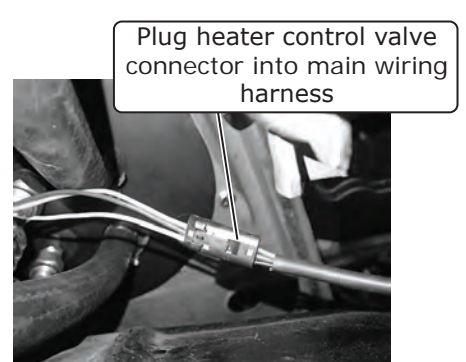

Photo 3

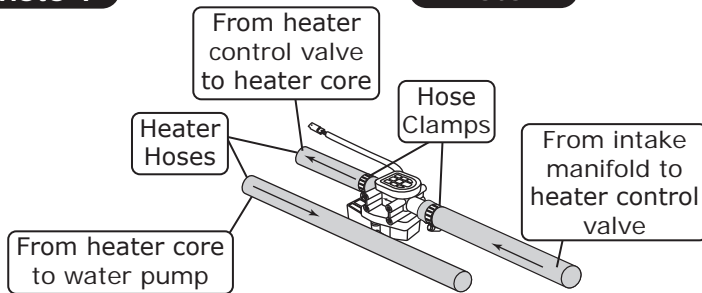

Figure 1

NOTE: Flow Direction Follows Molded Arrow on Valve.

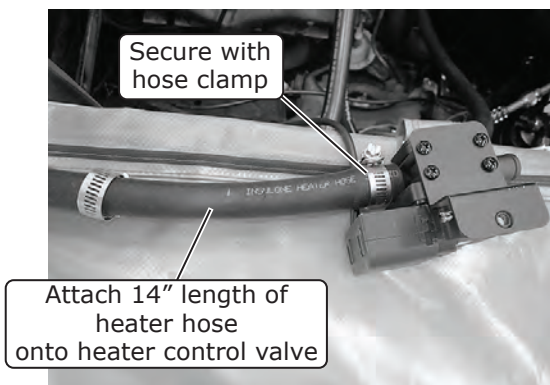

Photo 4

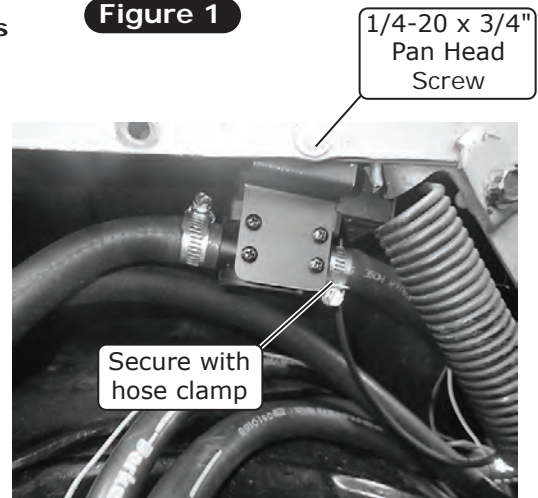

Photo 5



www.vintageair.com

A/C and Heater Hose Routing

NOTE: Vintage Air Systems use 5/8" heater connections. On engines equipped with 3/4" hose nipples, these will need to be removed and replaced with 5/8" nipples (not supplied). For water pumps with a cast-in 3/4" heater outlet, a 3/4" x 5/8" reducer fitting (not supplied) or molded hose (Vintage Air Part # 099010) will need to be installed in the heater hose.

NOTE: Flow Direction Follows Molded Arrow on Valve.

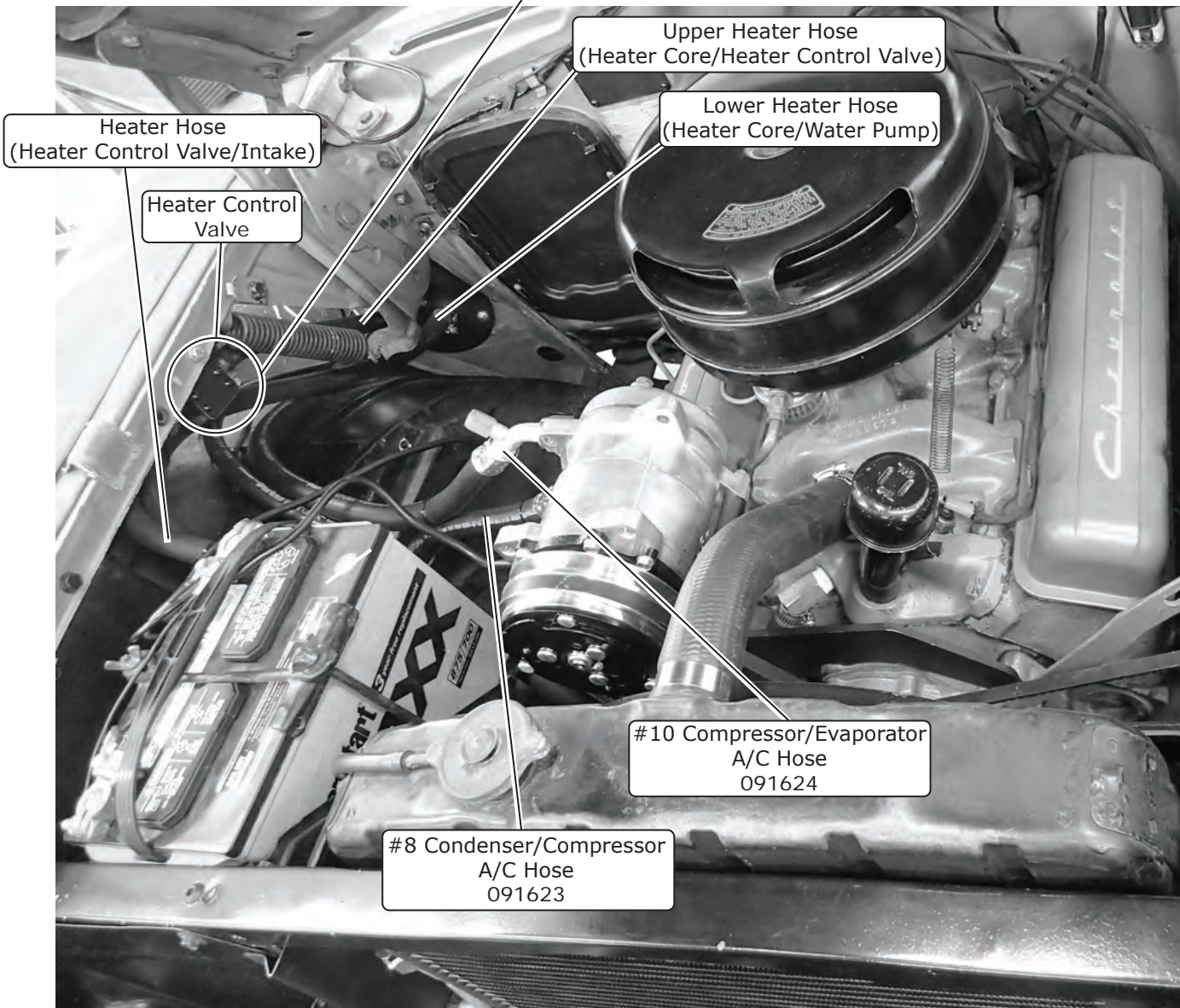

Photo 1



www.vintageair.com

Engine Compartment Wiring

NOTE: The following connections are critical to the performance of the system. Before making connections, refer to the Quality Crimp Guidelines, Page 36.

1. Route the blue wire from the main wiring harness along the #6 A/C hose and crimp on the supplied connector and connect it to the safety switch on the drier (See Photo 1, below). Secure the wire to the A/C hose using tie wraps.
2. Connect the bullet connector to the blue compressor lead (See Photo 2, below).
3. Route the compressor lead along the #8 A/C hose toward the drier and connect it to the safety switch (See Photo 3, below). Use the supplied tie wraps to secure the wiring to the A/C hoses.
4. Reinstall the battery tray using the OEM bolts (See Photo 4, below).
5. Route power and ground wires toward the battery (See Photo 5, below).
6. Install the supplied heat shrink over the 12 AWG orange standard fuse holder assembly wire and crimp it to the 12 AWG orange wire from the main wiring harness (See Photo 6, below). Slide the heat shrink over the crimp, then apply heat.

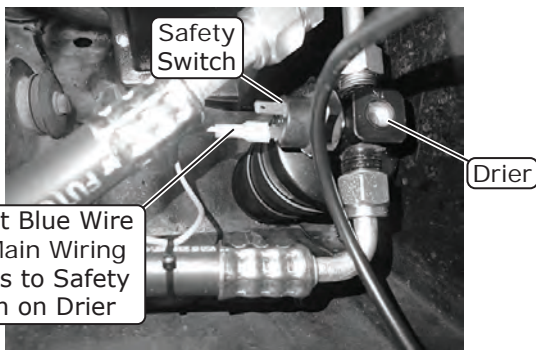

Photo 1

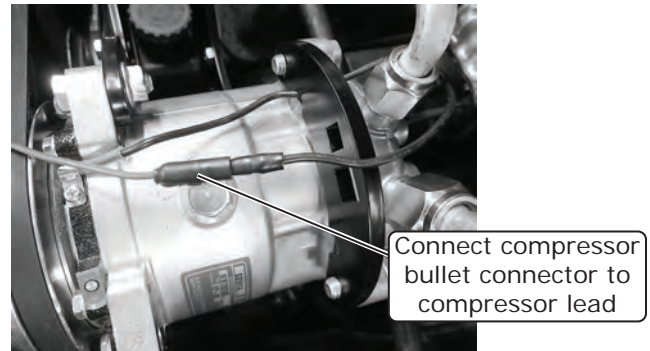

Photo 2

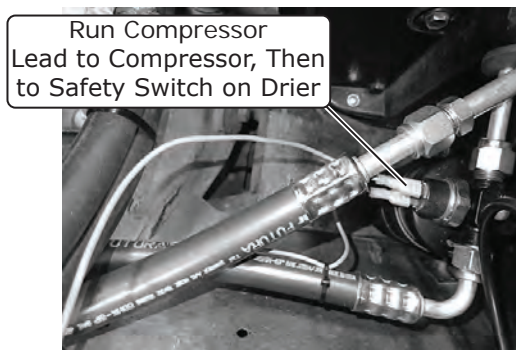

Photo 3



Photo 4

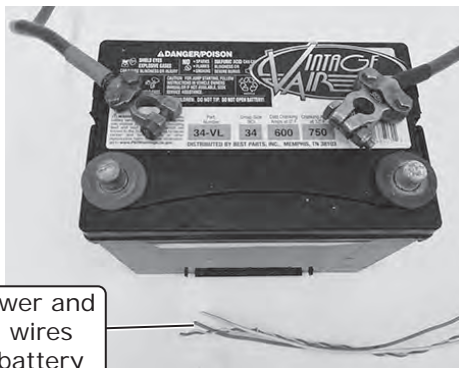

Photo 5

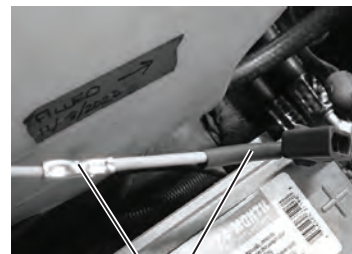

Photo 6



www.vintageair.com

Engine Compartment Wiring (Cont.)

7. Install the supplied heat shrink over the 16 AWG black fuse holder assembly wire and crimp it to the 16 AWG red wire from the main wiring harness (See Photo 7, below). Slide the heat shrink over the crimp, then apply heat.
8. Install the fuses into the holders (See Photos 8 and 9, below).
9. Install the supplied heat shrink over the white ground wires, then crimp on the supplied ring terminals (See Photos 10 and 11, below). Slide the heat shrink over the crimps, then apply heat. **NOTE: Both white wires can be crimped to the larger ring terminal. Install the heat shrink, then strip the wires, twist them together and trim to length. Crimp on the ring terminal, then slide the heat shrink over and apply heat (See Photos 12 and 13, below).**

Install supplied heat shrink over 16 AWG black fuse holder assembly wire and crimp it to 16 AWG red wire from main wiring harness



Photo 7

Install fuses into holders



Photo 8

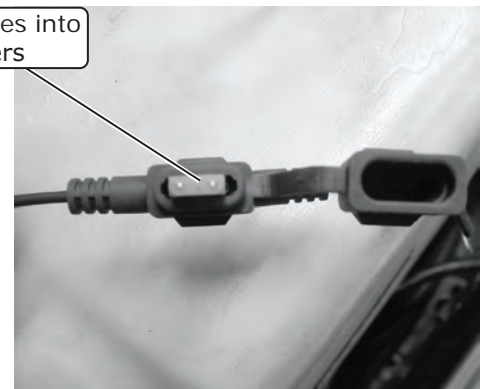

Photo 9

Install supplied heat shrink over white ground wires and crimp on supplied eyelets

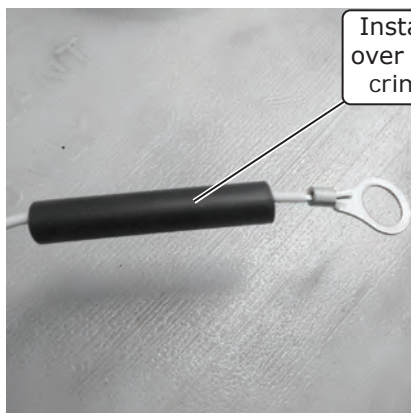

Photo 10

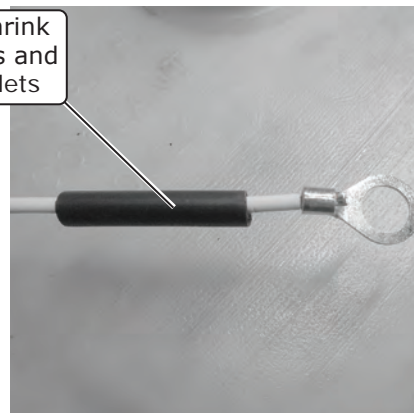

Photo 11

Both white ground wires can be crimped together. Install heat shrink, then strip wires, twist together and trim to length.

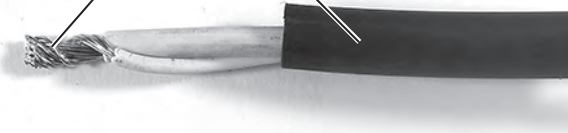

Photo 12

Crimp on ring terminal, then slide heat shrink over and apply heat

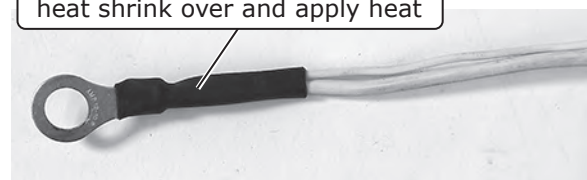

Photo 13



www.vintageair.com

Engine Compartment Wiring (Final)

10. Connect the ground wiring terminals to the negative battery terminal connector (See Photos 14 and 15, below).
11. Connect the positive wire ring terminals to the positive battery terminal connector (See Photos 16 and 17, below). **NOTE: Do not connect power until the installation is completed.**
12. Wiring completed (See Photo 18, below).

Connect ground wire ring terminals to negative battery terminal
NOTE: Either connection application can be used.

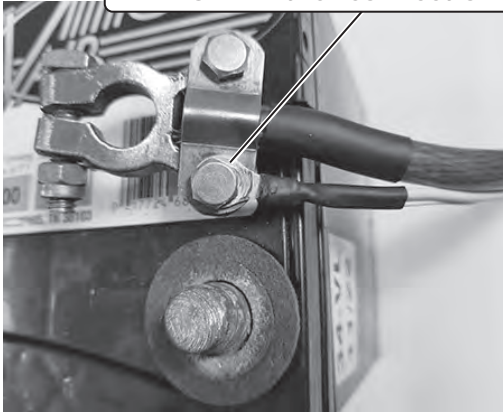

Photo 14

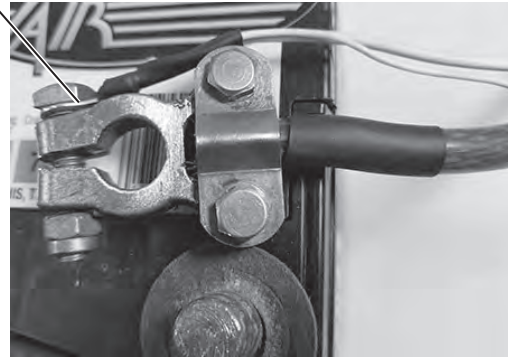

Photo 15

Connect power wire ring terminals to positive battery terminal
NOTE: Either connection application can be used.

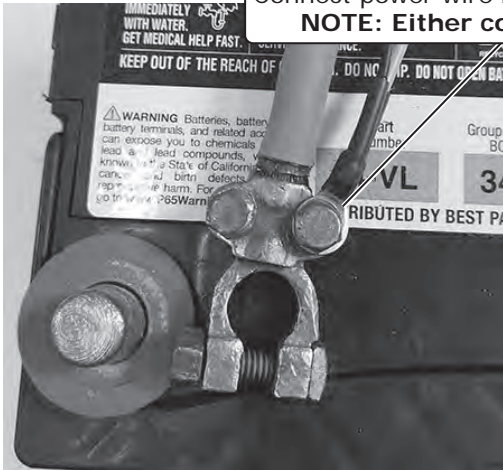
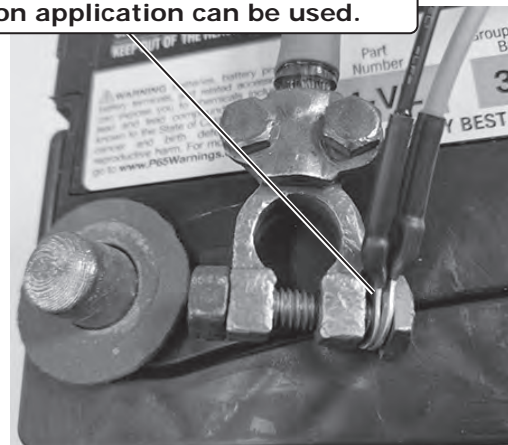

Photo 16



NOTE: Do not connect power until installation is completed.

Photo 17



Completed Installation Shown

Photo 18



www.vintageair.com

Final Steps: Completing the Install

1. Reinstall all previously removed items.
2. Fill radiator with at least a 50/50 mixture of approved antifreeze and distilled water. It is the owner's responsibility to keep the freeze protection at the proper level for the climate in which the vehicle is operated. Failure to follow antifreeze recommendations will cause heater core to corrode prematurely and possibly burst in A/C mode and/or freezing weather, voiding your warranty.
3. Double check all fittings, brackets and belts for tightness.
4. Vintage Air recommends that all A/C systems be serviced by a licensed automotive A/C technician.
5. Evacuate the system for a minimum of 45 minutes prior to charging, and perform a leak check prior to servicing.
6. Charge the system to the capacities stated on Page 4 of this instruction manual.
7. See Operation of Controls procedures on Page 39.



www.vintageair.com

Final Steps: Installation Check

Installation Check	
ITEM TO CHECK	Procedure
<input type="checkbox"/>	<p>ECU</p> <p>If no blinking is observed after 1 minute of turning the ignition on, go to the next check.</p> <p>If repetitive blinking is observed, go to the Advanced Diagnostics Section to diagnose.</p>
<input type="checkbox"/>	<p>Blower speed control</p> <p>Set the blower speed control to OFF, <u>confirm that the blower is off</u>.</p> <p>Position the blower speed control to LOW then MEDIUM and then HIGH. <u>At each setting confirm that the blower speed increases</u>, do this by feeling for the amount of air coming from the unit and hearing the blower speed increase.</p>
<input type="checkbox"/>	<p>Mode control</p> <p>Set the MODE control to the DASH position. <u>Confirm that air is being blown at the dash vents</u>.</p> <p>Set the MODE control to the FLOOR position. <u>Confirm that air is being blown at the floor vents</u>.</p> <p>Set the MODE control to the DEFROST position. <u>Confirm that all air is being blown from the defrost vents</u></p> <p>If heater lines are installed:</p> <p>Set the MODE control to the DASH position. Set the TEMP control to the MAX HEAT position. <u>Confirm that HOT air is coming from the dash vents</u>.</p>
<input type="checkbox"/>	<p>Temperature control</p> <p>If system is charged:</p> <p>Set the TEMP control to the MAX COOL position. <u>Confirm that COLD air is coming from the dash vents</u>.</p> <p>Also <u>confirm that the compressor "clicks" on</u> when adjusting the TEMP control from the MAX HEAT position to the MAX COOL position.</p>
<input type="checkbox"/>	<p>AC Indicator (If applicable)</p> <p>While the MODE control is set to the DASH position, and the TEMP control is set to the MAX COOL/MIN HEAT position, <u>confirm that the blue AC Indicator light is on</u>.</p>
<input type="checkbox"/>	<p>Backlight (If applicable)</p> <p>If your control panel has backlight capabilities and has been wired, turn the dash lamp on and <u>confirm that the AC panel's legend is lit</u>.</p>
<input type="checkbox"/>	<p>Fittings</p> <p>Verify AC and Heater fittings are all tight.</p>



www.vintageair.com

Duct Hose Routing

NOTE: For the system to function optimally, the duct hoses must be routed as directly as possible, taking care to avoid kinks, sharp bends and unnecessary length. Vintage Air supplies duct hoses in continuous lengths that will need to be cut to size depending on application. Before cutting, familiarize yourself with the installation instructions and verify the routing will work with your application. For custom hose routing, additional hose may be needed and can be purchased from Vintage Air.

1. Stretch the duct hose until there is no slack, measure, mark and cut hose to size (See Photo 1, below).

Stretch, measure, mark and cut hose to size



Photo 1

Disclaimer: Before cutting duct hose to length, verify the routing will work for your application.

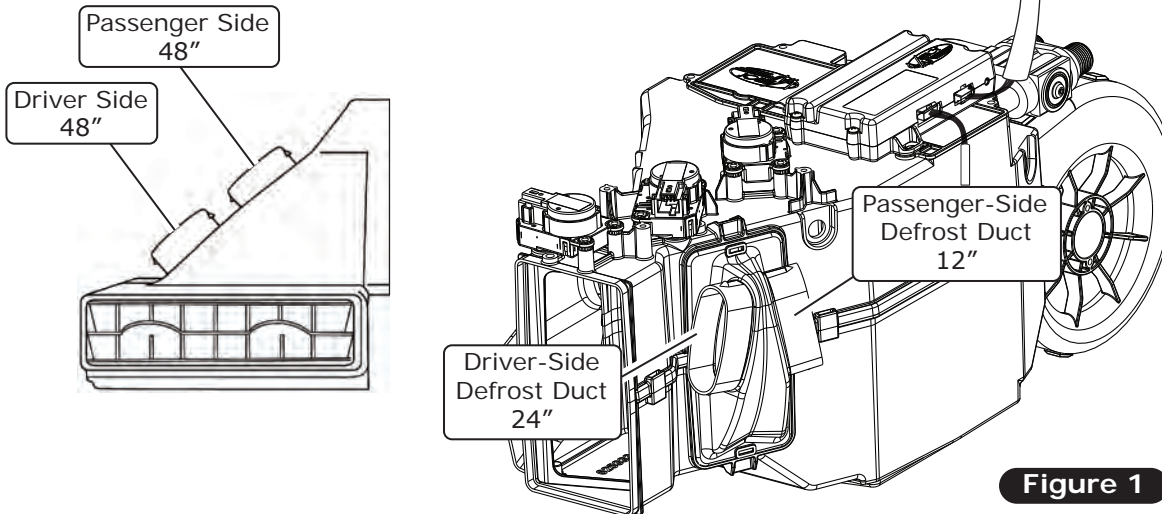

Figure 1



NOTE: ECU must be placed away from water and humidity, and also be accessible for servicing. If relocating, connectors must be positioned towards the bottom.

Position connectors towards bottom



www.vintageair.com

Quality Crimp Guideline

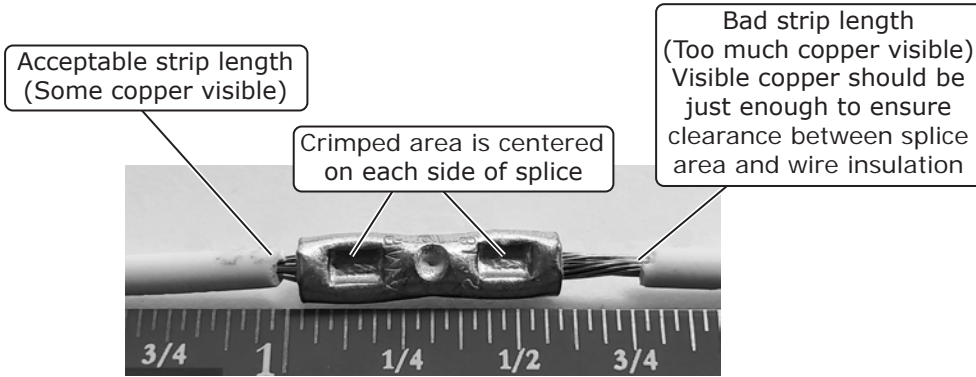

Photo 1

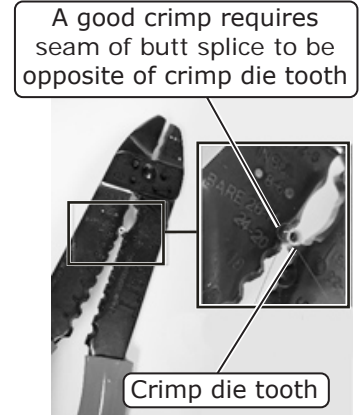

Photo 2

Good Ring Terminal Crimp Bad Ring Terminal Crimp

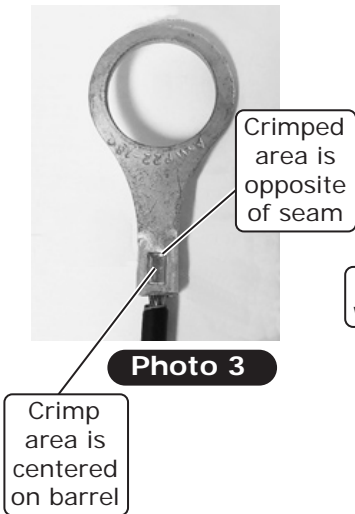

Photo 3

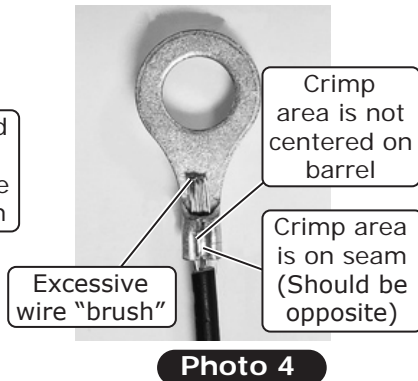

Photo 4

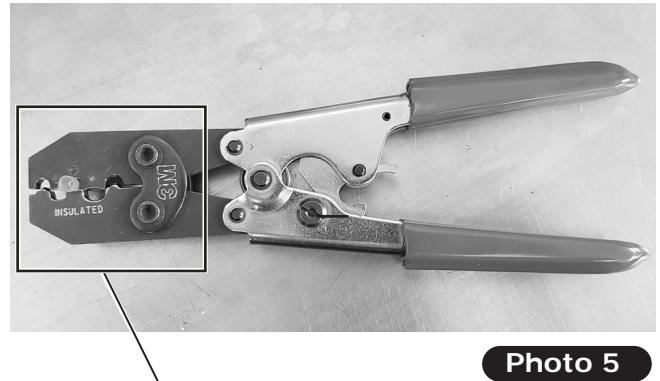

Photo 5

Use a ratcheting crimp tool for insulated barrel terminals when crimping the provided female insulated terminal. Ensure terminal is inserted in appropriate position before crimping.

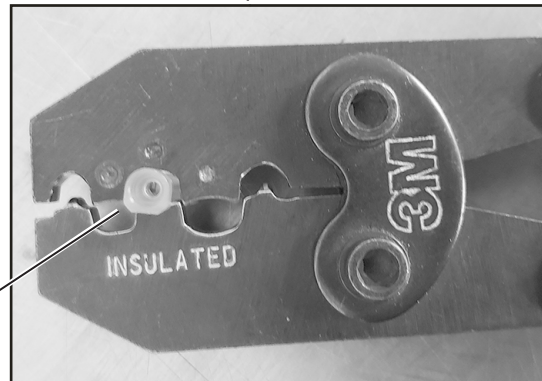
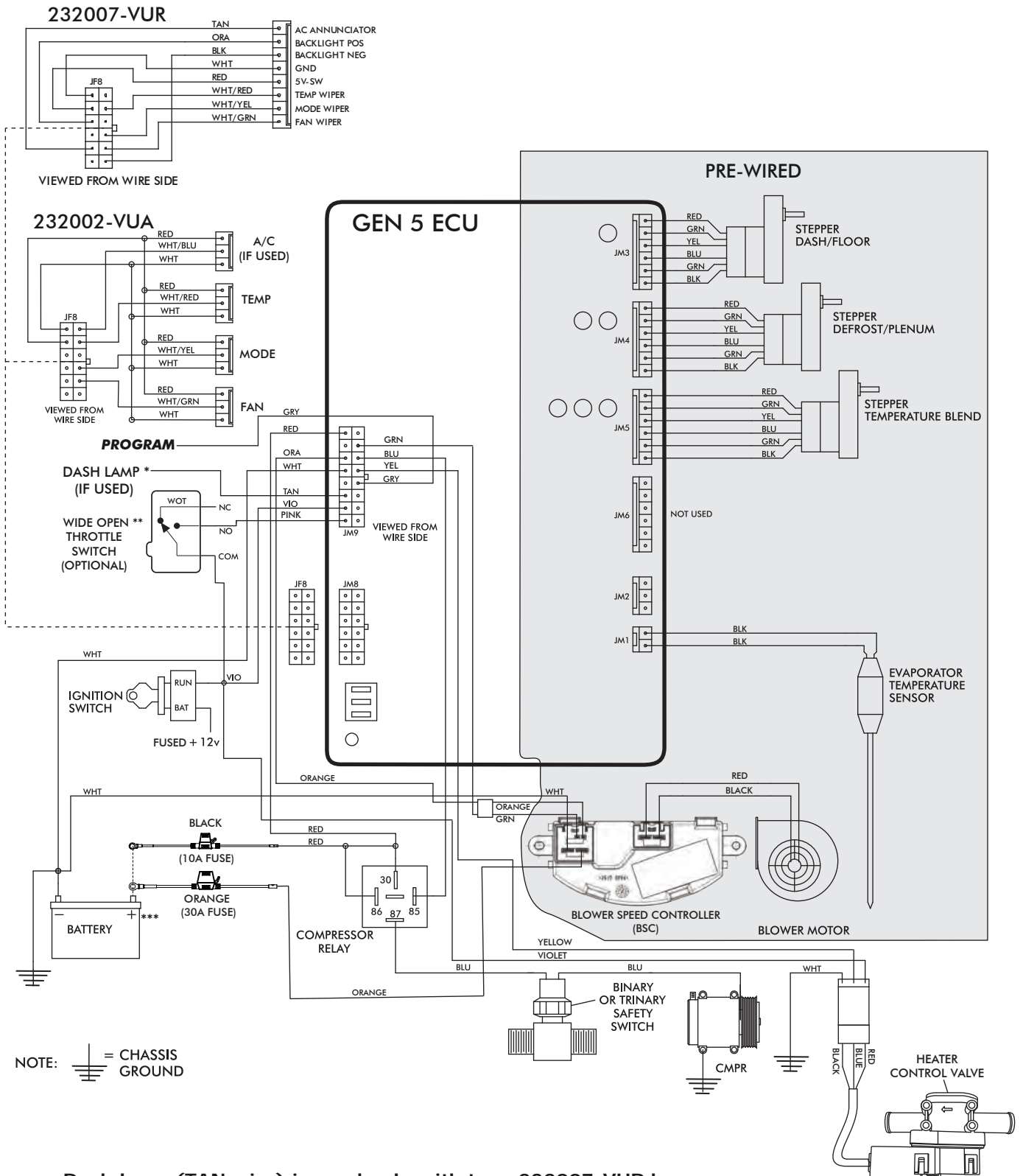

Photo 5a



www.vintageair.com

Gen 5 Wiring Diagram



NOTE: = CHASSIS GROUND

- * Dash lamp (TAN wire) is used only with type 232007-VUR harness.
- ** Wide open throttle switch contacts close only at full throttle, which disables A/C compressor.
- *** Install fuse assemblies at or as near to the battery as possible.



www.vintageair.com

Gen 5 Wiring Instructions

WIRING HARNESS (231505) ↓

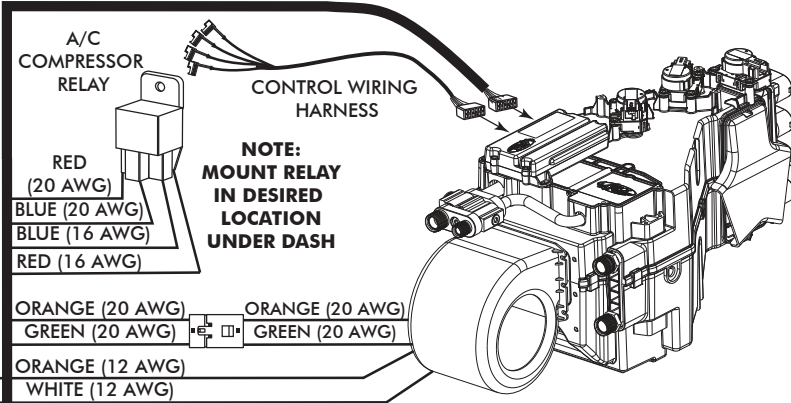

Ignition Switch:
Using provided butt splice (PN 226004), connect the 20 AWG violet wire to a 5A fused and switched 12V source such as Key On.

Wide Open Throttle Switch (Optional):
If a wide open throttle switch is required, connect the 20 AWG pink wire to a normally open switch that, when closed, connects a fused and switched 12V source to the pink wire. See Gen 5 wiring diagram for an example.

Dash Light (Optional):
If using a Vintage Air control panel with back light, connect the 20 AWG tan wire to the vehicle's dash back light 0-12V using provided butt splice (PN 226004).

WIRING HARNESS (232020) →

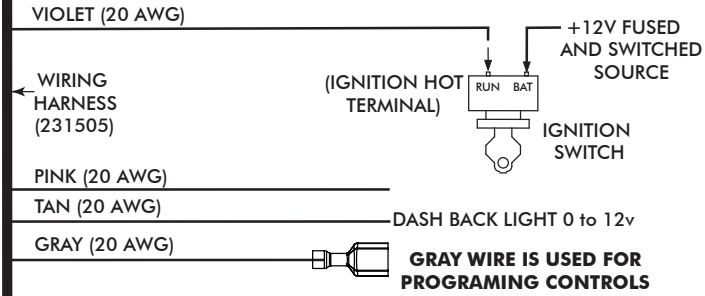

FIREWALL FIREWALL

WIRING HARNESS (232020) →

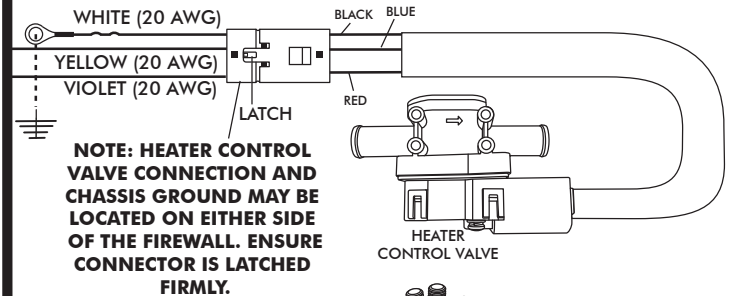

Heater Control Valve:
Connect the Violet/Yellow/White twisted branch with 3 position connector into the heater control valve connector. Ensure that the mating latch is fully seated.

Binary/Trinary & Compressor:
Binary Switch: Terminate provided insulated female terminal (PN 23172-VUW) to the blue 16 AWG wire. Connect as shown.
Trinary Switch: Connect according to trinary switch wiring diagram.

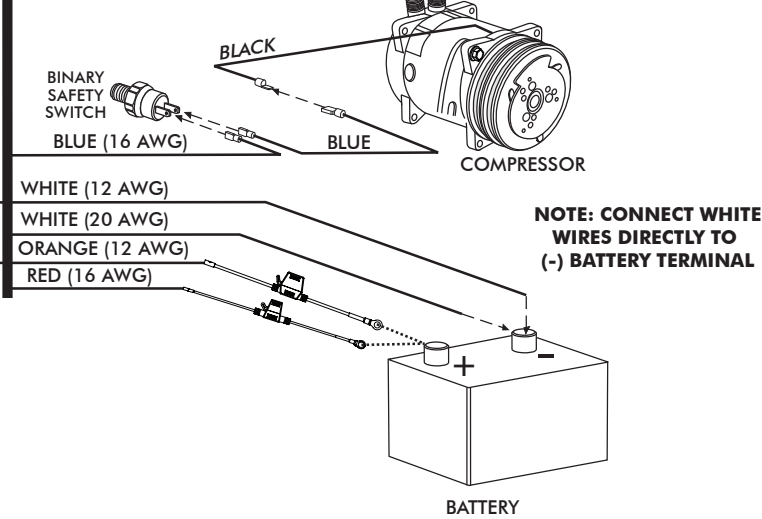

Battery Connections:
ECU Ground: Terminate provided ring terminal (PN 226110) to 20 AWG white wire from the 231505 wire assembly and install at battery.
ECU PWR: Terminate provided fuse assembly with black leads (PN 233012) to the 16 AWG red wire from the 231505 wire assembly. Install provided 10A Red Mini Fuse (PN 226118). Install at battery.
Blower Speed Controller (BSC) Ground: Terminate provided ring terminal (PN 226111) to 12 AWG white wire from the 232020 wire assembly and install at battery.
Blower Speed Controller (BSC) PWR: Terminate provided fuse assembly with orange leads (PN 233008) to the 12 AWG orange wire from the 232020 wire assembly. Install provided 30A Green ATO/ATC Fuse (PN 226125). Install at battery.



www.vintageair.com

Operation of Controls

On Gen IV or Gen 5 systems with three lever/knob controls, the temperature control toggles between heat and A/C operations. To activate A/C, move the temperature lever/knob all the way to cold and then back it off to the desired vent temperature. For heat operation, move the temperature lever/knob all the way to hot and then adjust to the desired vent temperature. The blower will momentarily change speed, each time you toggle in and out of heat and A/C operations, to indicate the change. **NOTE: For proper control panel function, refer to Control Panel Kit instructions.**

Blower Speed

This lever/knob controls blower speed, from OFF to HI.

Mode Control

This lever/knob controls the mode positions, from DASH to FLOOR to DEFROST, with a blend in between.

Temperature Control

This lever/knob controls the temperature, from HOT to COLD.

* Inside/Outside Air Control

The inside/outside air control operates the fresh air door. **NOTE: For optimal system performance, use inside air.**

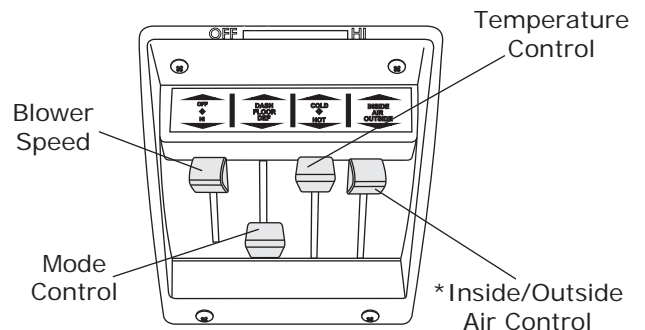

A/C Operation

Blower Speed

Adjust to desired speed.

Mode Control

Adjust to desired mode position (DASH position recommended).

Temperature Control

For A/C operation, adjust to coldest position to engage compressor (Adjust between HOT and COLD to reach desired temperature).

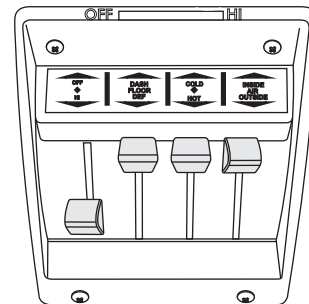

Heat Operation

Blower Speed

Adjust to desired speed.

Mode Control

Adjust to desired mode position (FLOOR position recommended).

Temperature Control

For maximum heating, adjust to hottest position (Adjust between HOT and COLD to reach desired temperature).

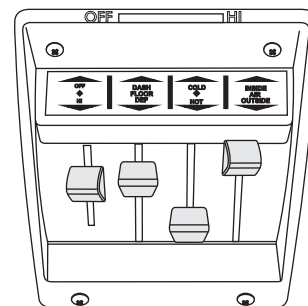

Defrost/De-fog Operation

Blower Speed

Adjust to desired speed.

Temperature Control

Adjust to desired temperature.

Mode Control

Adjust to DEFROST position for maximum defrost, or between FLOOR and DEFROST positions for a bi-level blend (Compressor is automatically engaged).

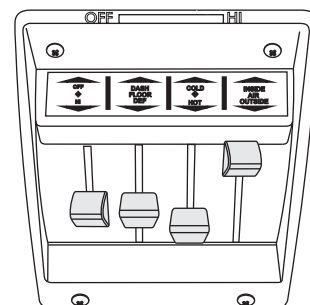



www.vintageair.com

Troubleshooting Guide

This printed troubleshooting guide is our basic guide that covers common installation problems. To see our advanced diagnostics and troubleshooting guide, please refer to the following page for instructions on how to download the complete guide.

WARNING: While troubleshooting the system, never probe connector terminals from the front mating side, only back probe.

WARNING: While troubleshooting the system, never use automotive check lights.

Symptom	Condition	Checks	Actions	Notes
1. Blower stays on high speed with ignition on.	No other functions work.	Check for damaged pins or wires in the control panel wire assembly and mating header at ECU.	If found damaged, replace wire assembly or ECU.	If fuse continues to blow, there is a serious problem in the wiring. Check all wiring and ensure the wire is not damaged and shorting out along its route.
	All other functions work.	Check for a bad ECU GND. Check for damaged pins or wires in the control panel wire assembly and mating header at ECU. Check if Blower power fuse is blown. Check for a bad ECU GND.	If found damaged, replace wire assembly or ECU. Replace fuse. Repair connection.	
2. Compressor will not turn on (All other functions work).	System is not charged.	System must be charged for compressor to engage.	Charge system.	Danger: Never bypass safety switch with engine running. Serious injury can result.
	System is charged.	Check for faulty A/C potentiometer or associated wiring (not applicable to 3-pot controls).	Check continuity to ground on white control head wire. Check for 5V on red control head wire.	To check for proper pot function, check voltage at white/red wire. Voltage should be between 0V and 5V, and will vary with pot lever position.
		Check for disconnected or faulty thermistor.	Check 2-pin connector at ECU housing.	Disconnected or faulty thermistor will cause compressor to be disabled.
3. Compressor will not turn off (All other functions work).	Compressor will not turn off (All other functions work).	Check for faulty A/C potentiometer or associated wiring.	Repair or replace pot/control wiring.	Red wire at A/C pot should have approximately 5V with ignition on. White wire will have continuity to chassis ground. White/Red wire should vary between 0V and 5V when lever is moved up or down.
		Check for faulty A/C relay.	Replace relay.	



www.vintageair.com

Troubleshooting Guide (Cont.)

Symptom	Condition	Checks	Actions	Notes
4. System will not turn on, or runs intermittently.	Works when engine is not running; shuts off when engine is started	Noise interference from either ignition or alternator.	Install capacitors on ignition coil and alternator. Ensure good ground at all points. Relocate coil and associated wiring away from ECU and ECU wiring. Check for burned or loose plug wires.	Ignition noise (radiated or conducted) will cause the system to shut down due to high voltage spikes. If this is suspected, check with a quality oscilloscope. Spikes greater than 16V will shut down the ECU. Install a radio capacitor at the positive post of the ignition coil (see radio capacitor installation bulletin). A faulty alternator or worn out battery can also result in this condition.
	Will not turn on under any conditions.	Verify connections on power lead, ignition lead, and both white ground wires. Verify battery voltage is greater than 10 volts and less than 16 while engine is running.	Check for power at ECU, and confirm ignition is being applied to ECU properly. Verify proper meter function by checking the condition of a known good battery.	
5. Loss of mode door function.	No mode change at all.	Check for damaged mode switch or potentiometer and associated wiring.		
	Blower turns on and off rapidly.	Battery voltage is at least 12V. Battery voltage is less than 12V.	Ensure all system grounds and power connections are clean and tight. Charge battery.	System shuts off blower at 10V. Poor connections or weak battery can cause shutdown at up to 11V.
7. Erratic functions of blower, mode, temp, etc.		Check for damaged switch or pot and associated wiring.	Repair or replace.	

Advanced Diagnostics and Troubleshooting Guide

If after referencing the Troubleshooting Guide, the issue is not resolved, move to The Advanced Diagnostics and Troubleshooting Guide that covers the following:

- ECU Diagnostics Codes
 1. **ECU Blink Sequence**
 2. **Firmware Version Number**
 3. **ECU Model Number**
 4. **ECU Start-Up Blink Sequence**
 5. **Diagnostic Codes**
- Complete Advanced Troubleshooting Guidelines

Access the latest version of the Advanced Diagnostics and Troubleshooting Guide by scanning the following QR code on your mobile device:



You can also access the guide by typing the following address into your web browser:

https://www.vintageair.com/instructions_pdf/905000.pdf



www.vintageair.com

Packing List: Evaporator Kit (561552)

No.	Qty.	Part No.	Description
1.	1	765200	Gen 5 Super Magnum Module with 404 ECU
2.	1	781552	Accessory Kit

Checked By: _____
Packed By: _____
Date: _____

1

Gen 5 Super Magnum
Module with 404 ECU
765200



2

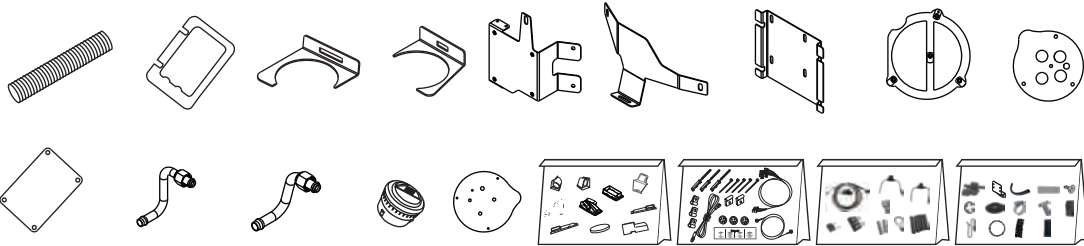

Accessory Kit
781552

NOTE: Images may not depict actual parts and quantities.
Refer to packing list for actual parts and quantities.

Packing List: Evaporator Kit (561556)

No.	Qty.	Part No.	Description
1.	1	765200	Gen 5 Super Magnum Module with 404 ECU
2.	1	781556	Accessory Kit

Checked By: _____
Packed By: _____
Date: _____

1

Gen 5 Super Magnum
Evaporator Module
765200



2

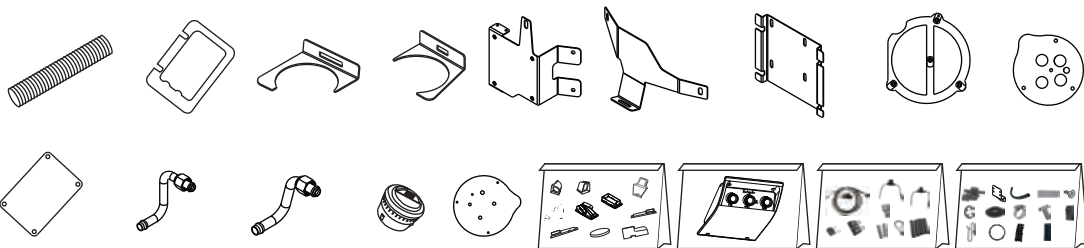

Accessory Kit
781556

NOTE: Images may not depict actual parts and quantities.
Refer to packing list for actual parts and quantities.