

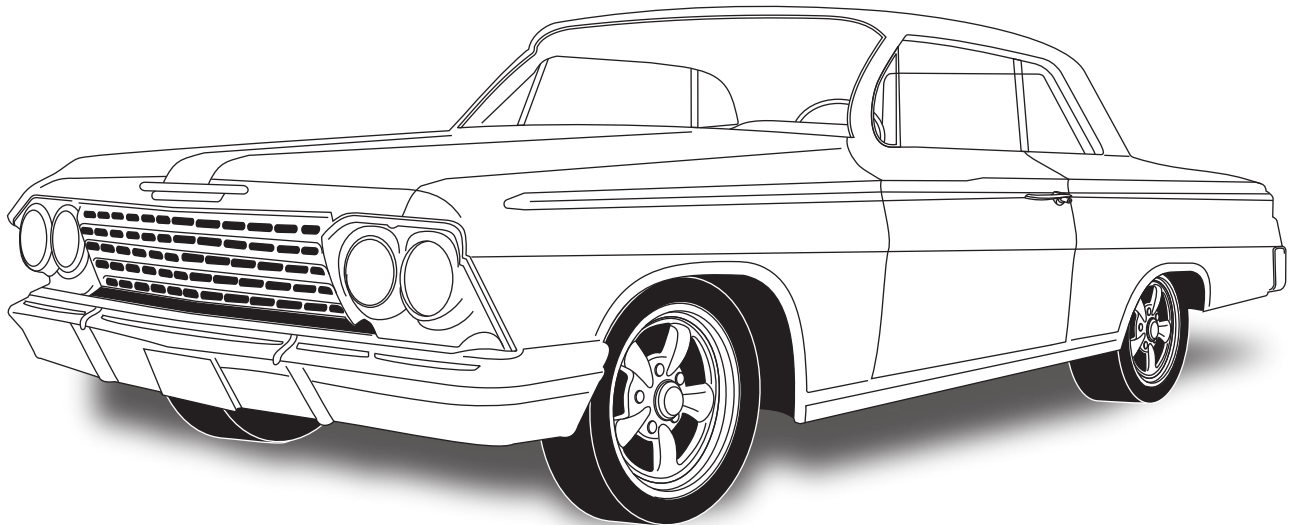

1961-62 Chevrolet Impala

without Factory Air
Gen 5 Evaporator Kit
(561355)



18865 Goll St. San Antonio, TX 78266
Phone: 800-862-6658
Sales: sales@vintageair.com
Tech Support: tech@vintageair.com
www.vintageair.com



www.vintageair.com

Table of Contents

Cover.....	1
Table of Contents.....	2
Packing List/Parts Disclaimer.....	3
Information Page.....	4
Wiring Notice.....	5
Engine Compartment Disassembly, Condenser Assembly and Installation, Compressor and Brackets, Pulleys.....	6
Passenger Compartment.....	7
Firewall Cover Preparation & Modification, Firewall Cover Installation & Insulation.....	8
Defrost Duct Installation.....	9
Speaker Mounting, Kick Panel Modification.....	10
Kick Panel Modification (Cont.), Fresh Air & Kick Panel Cover Preparation.....	11
Lubricating O-rings, Properly Seated O-ring Land, Evaporator Module Preparation.....	12
Evaporator Module Preparation (Cont.).....	13
Wiring Installation.....	14
Kick Panel & Fresh Air Cover Installation.....	15
Passenger Compartment Wiring, Evaporator Installation.....	16
Evaporator Installation (Cont.).....	17
Drain Hose Installation, Driver-Side Under Dash Louver Mounting Holes.....	18
Passenger-Side Under Dash Louver Mounting Holes, Driver-Side Under Dash Louver Installation, Center/Passenger-Side Under Dash Louver Installation.....	19
Heater Hose & Heater Control Valve Installation, A/C and Heater Hose Routing.....	20
Inner Fender Installation, Engine Compartment Wiring.....	21-22
Final Steps: Installation Check.....	23
Final Steps: Completing the Install.....	24
Duct Hose Routing.....	25
Quality Crimp Guideline.....	26
Gen 5 Wiring Diagram.....	27
Gen 5 Wiring Connection Instruction.....	28
Operation of Controls.....	29
Troubleshooting Guide.....	30
Troubleshooting Guide (Cont.), Advanced Diagnostics and Troubleshooting Guide.....	31
Templates: Driver-Side Under Dash Louver Bezel & Defrost Duct Mounting.....	32
Packing List.....	33



www.vintageair.com

Packing List: Evaporator Kit (561355)

No.	Qty.	Part No.	Description
1.	1	765200	Gen 5 Magnum Max Module with 404 ECU
2.	1	781355	Accessory Kit

**** Before beginning installation, open all packages and check contents of shipment. Please report any shortages directly to Vintage Air within 15 days. After 15 days, Vintage Air will not be responsible for missing or damaged items.**

1



Gen 5 Magnum Max
Module with 404 ECU
765200

2

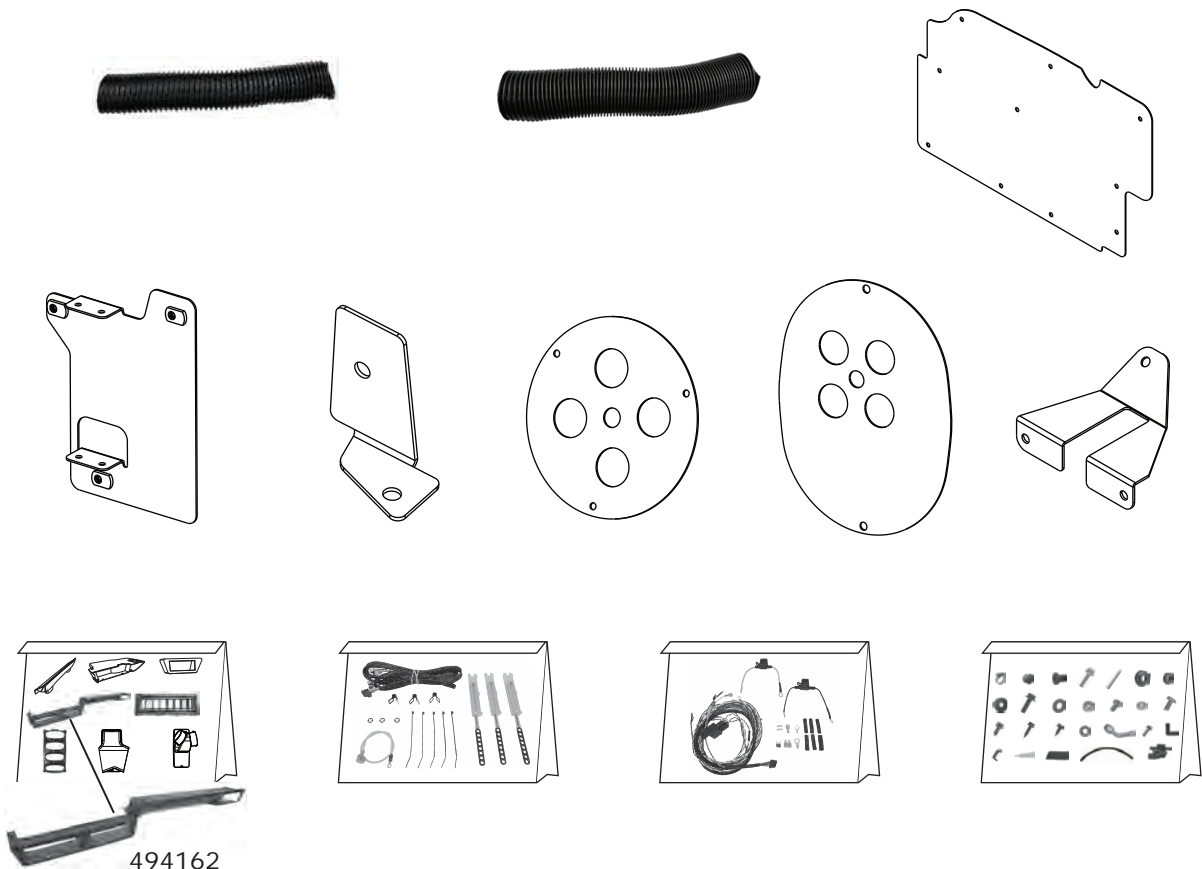

Accessory Kit
781355

NOTE: Images may not depict actual parts and quantities. Refer to packing list for actual parts and quantities.



www.vintageair.com

Important Notice—Please Read

For Maximum System Performance, Vintage Air Recommends the Following:

NOTE: Vintage Air systems are designed to operate with R134a refrigerant only. Use of any other refrigerant could damage your A/C system and/or vehicle, and possibly cause a fire, in addition to potentially voiding the warranties of the A/C system and its components.

Refrigerant Capacities:

Vintage Air System: 1.8 lbs. (28.8 oz.) or 816 grams of **R134a**, charged by weight with a quality charging station or scale. **NOTE: Use of the proper type and amount of refrigerant is critical to system operation and performance.**

Other Systems: Consult manufacturer's guidelines.

Lubricant Capacities:

New Vintage Air-Supplied Sanden Compressor: No additional oil needed (Compressor is shipped with proper oil charge).

All Other Compressors: Consult manufacturer (Some compressors are shipped dry and will need oil added).

Safety Switches

Your Vintage Air system is equipped with a binary pressure safety switch. A binary switch disengages the compressor clutch in cases of extreme low pressure conditions (refrigerant loss) or excessively high head pressure (406 PSI) to prevent compressor damage or hose rupture. A trinary switch combines Hi/Lo pressure protection with an electric fan operation signal at 254 PSI, and should be substituted for use with electric fans. Compressor safety switches are extremely important since an A/C system relies on refrigerant to circulate lubricant.

Service Info:

Protect Your Investment: Prior to assembly, it is critical that the compressor, evaporator, A/C hoses and fittings, hardlines, condenser and receiver/drier remain capped. Removing caps prior to assembly will allow moisture, insects and debris into the components, possibly leading to reduced performance and/or premature failure of your A/C system. This is especially important with the receiver/drier.

Additionally, when caps are removed for assembly, **BE CAREFUL!** Some components are shipped under pressure with dry nitrogen.

Evacuate the System for 35-45 Minutes: Ensure that system components (Drier, compressor, evaporator and condenser) are at a temperature of at least 85°F. On a cool day, the components can be heated with a heat gun **or** by running the engine with the heater on before evacuating. Leak check and charge to specifications.

Bolts Passing Through Cowl and/or Firewall:

To ensure a watertight seal between the passenger compartment and the vehicle exterior, for all bolts passing through the cowl and/or firewall, Vintage Air recommends coating the threads with silicone prior to installation.

Heater Hose (not included with this kit):

Heater hose may be purchased from Vintage Air (Part#31800-VUD) or your local parts retailer. Routing and required length will vary based on installer preference.



www.vintageair.com

Important Wiring Notice—Please Read

Some vehicles may have had some or all of their radio interference capacitors removed. There should be a capacitor found at each of the following locations:

- 1. On the positive terminal of the ignition coil.**
- 2. If there is a generator, on the armature terminal of the generator.**
- 3. If there is a generator, on the battery terminal of the voltage regulator.**

Most alternators have a capacitor installed internally to eliminate what is called “whining” as the engine is revved. If whining is heard in the radio, or just to be extra cautious, a radio interference capacitor can be added to the battery terminal of the alternator.

It is also important that the battery lead is in good shape and that the ground leads are not compromised. There should be a heavy ground from the battery to the engine block, and additional grounds to the body and chassis.

If these precautions are not observed, it is possible for voltage spikes to be present on the battery leads. These spikes come from ignition systems and charging systems, and from switching some of the vehicle’s other systems on and off. Modern computer-operated equipment can be sensitive to voltage spikes on the power leads, which can cause unexpected resets, strange behavior and/or permanent damage.

Vintage Air strives to harden our products against these types of electrical noise, but there is a point where a vehicle’s electrical system can be degraded so much that nothing can help.

Radio interference capacitors should be available at most auto and truck parts suppliers. They typically are cylindrical in shape, a little over an inch long and a little over a half-inch in diameter, and they have a single lead coming from one end of the cylinder with a terminal on the end of the wire, as well as a mounting clip which is screwed into a good ground on the vehicle. The specific value of the capacitance is not too significant in comparison to ignition capacitors that are matched with the coil to reduce pitting of the points.

- Care must be taken, when installing the compressor lead, not to short it to ground. The compressor lead must not be connected to a condenser fan or to any other auxiliary device. Shorting to ground or connecting to a condenser fan or any other auxiliary device may damage wiring or the compressor relay, and/or cause a malfunction.
- When installing ground leads on Gen 5 systems, the blower control ground and ECU ground must be connected directly to the negative battery post.
- For proper system operation, the heater control valve must be connected to the ECU.



www.vintageair.com

Engine Compartment Disassembly

NOTE: Before starting the installation, check the function of the vehicle (horn, lights, etc.) for proper operation, and study the instructions, illustrations, photos & diagrams.

Perform the following:

1. Disconnect the battery.
2. Remove the battery (retain).
3. Drain the radiator.
4. Remove the OEM blower assembly (discard) (See Figure 1, below).
5. Remove the passenger-side inner fender well.

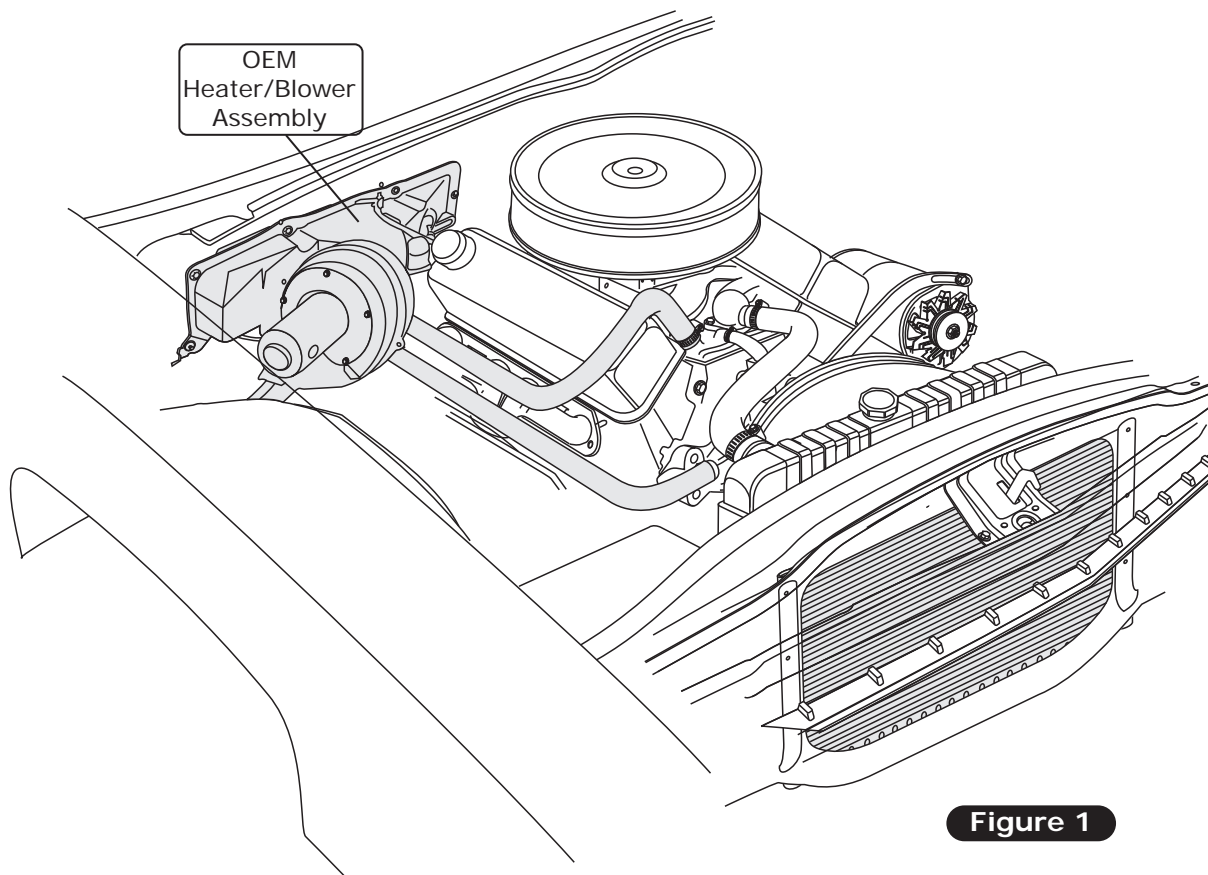

Figure 1

Condenser Assembly and Installation

1. Refer to separate instructions included with the condenser kit to install the condenser.
2. Binary switch installation (Refer to condenser instructions).

Compressor and Brackets

1. Refer to separate instructions included with the bracket kit to install the compressor bracket.

Pulleys

1. In most instances, the belt lengths will remain the same.



www.vintageair.com

Passenger Compartment Disassembly

Perform the following:

1. Remove the OEM control panel assembly (retain) (See Figure 1, below).
2. Remove the OEM heater assembly (discard) (See Figure 1, below).
3. Remove the glove box (discard) and the glove box door (retain) (See Figure 1, below).
4. Remove the radio and speaker (retain) (See Figure 1, below).
5. Remove the OEM defrost duct assembly (discard) (See Figures 1 & 2, below).
6. Remove the (3) spot welds on the defrost duct with a chisel or die grinder (See Figure 2, below).

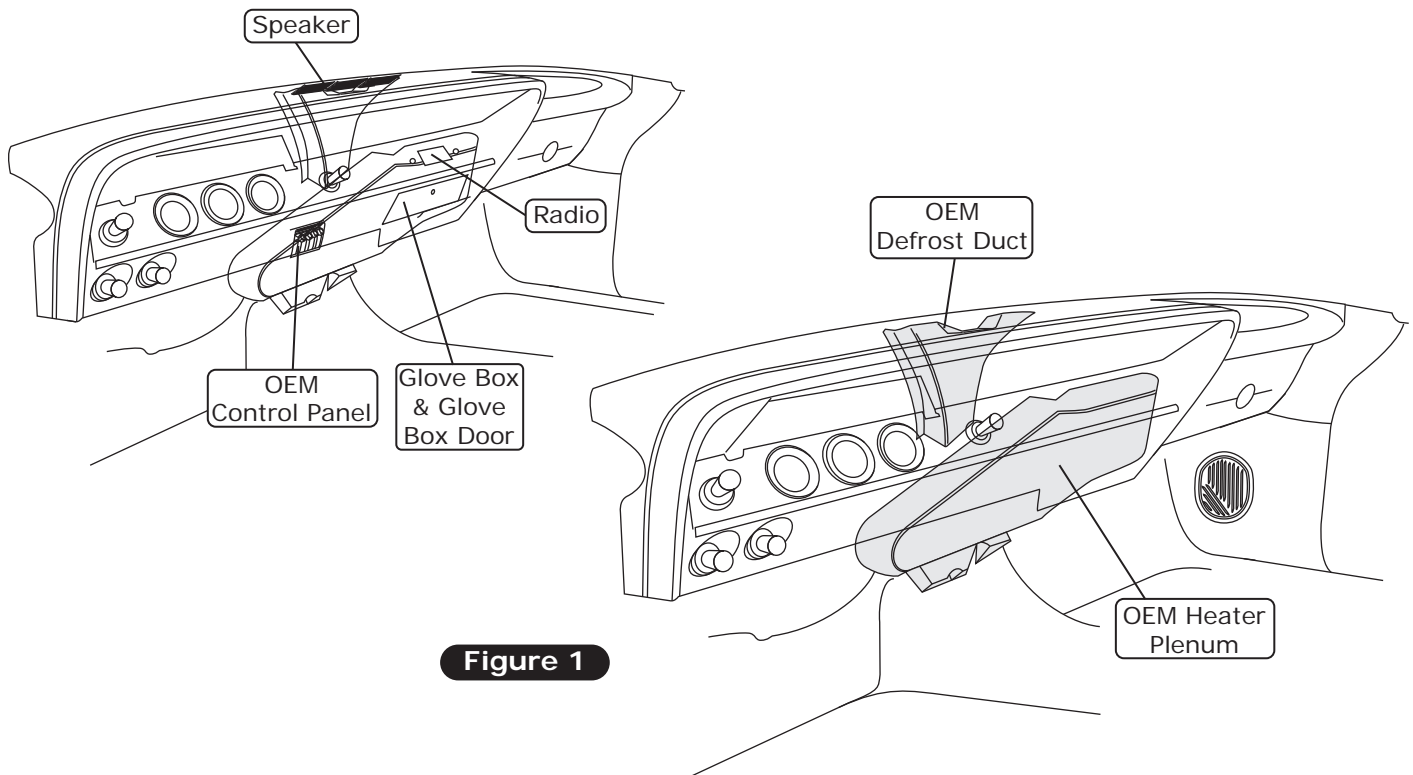

Figure 1

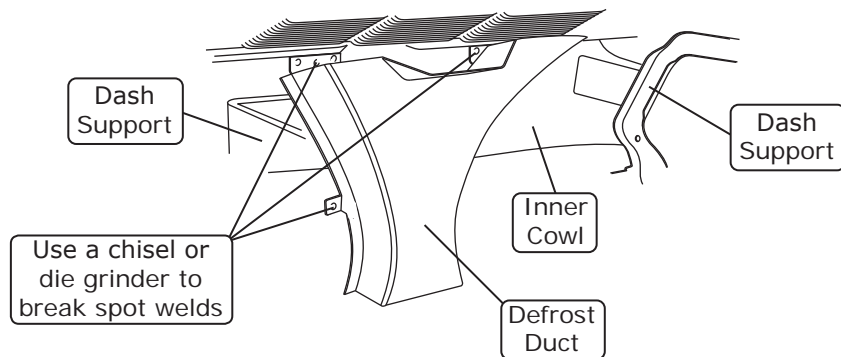

Figure 2



www.vintageair.com

Firewall Cover Preparation & Firewall Modification

NOTE: For proper system operation, Vintage Air recommends using Dynaliner (461500-VIP) heatblocking insulation in the area around the evaporator module (firewall, kick panel, inner cowl and firewall covers). Due to tight clearance for the evaporator module, between the firewall and dash, Vintage Air recommends an insulation thickness of no more than 1/8". Firewall modification is required for firewall cover and drain hose installation.

1. Flatten the edges of the firewall opening (See Photo 1, below).
2. Install (5) 1/4-20 x 3/4" serrated flange black bolts with (5) 1/4" pushnut bolt retainers onto the firewall cover (See Photo 2, below).

Remove or flatten edges of firewall opening

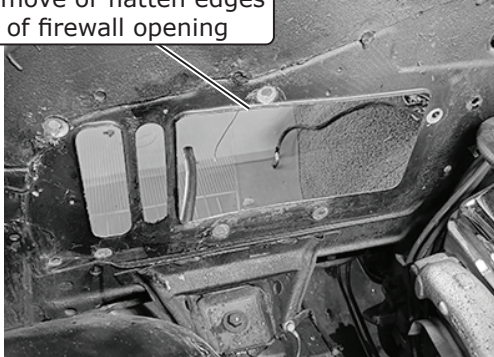

Photo 1

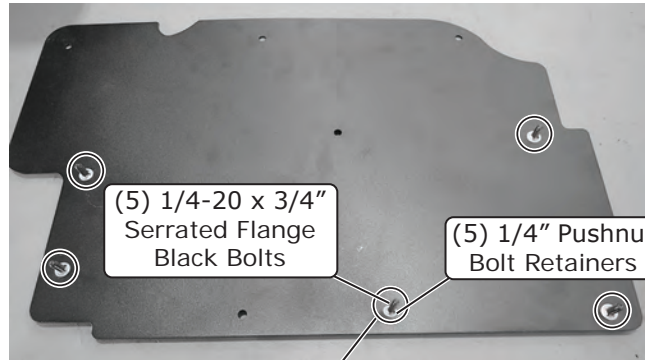

Photo 2

Firewall Cover Installation and Insulation

1. Apply silicone to the mating surface of the firewall cover.
2. Install the firewall cover onto the firewall, then secure it using (5) 1/4" USS flat washers and (5) 1/4-20 nuts with star washers (See Photo 1, below).
3. Install (3) #14 sheet metal screws in the top three mounting holes (See Photo 2, below).
4. Clean the firewall and necessary areas, then apply heat-blocking insulation (See Photo 3, below).

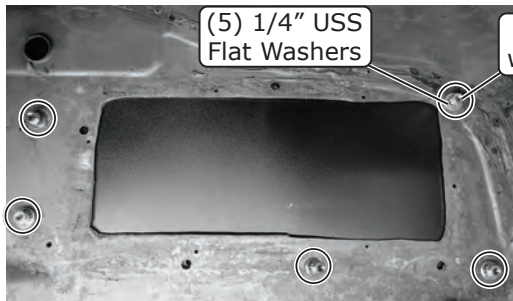

Photo 1

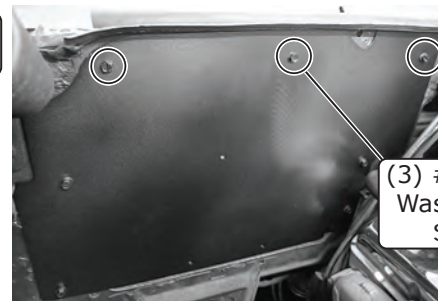

Photo 2

Apply heat-blocking insulation



Photo 3



www.vintageair.com

Defrost Duct Installation

1. Cut out the defrost duct mounting template on Page 25?
2. Place the template onto the inner cowl. Once aligned, tape the template into place (See Figure 1, below).
3. Using a center punch or scribe, mark the (2) mounting holes on the inner cowl (See Figure 1, below).
4. Once the holes are marked, remove the template and drill (2) 1/8" holes into the inner cowl.
5. Install a J-nut onto the end of the speaker bracket as shown in Figure 2a, below.
6. Place the defrost duct under the dash, and align it with the OEM defrost opening in the dash and the mounting holes in the inner cowl.
7. Once the defrost duct and defroster/speaker bracket are aligned, secure the defrost duct and the speaker bracket to the inner cowl using (2) #10 x 1/2" sheet metal screws (See Figures 2 and 2a, below).
8. Install (2) 3' pieces of duct hose to the defrost duct (See Photo 1, below). **NOTE: Once the evaporator module is installed it will be difficult to install the duct hose.**

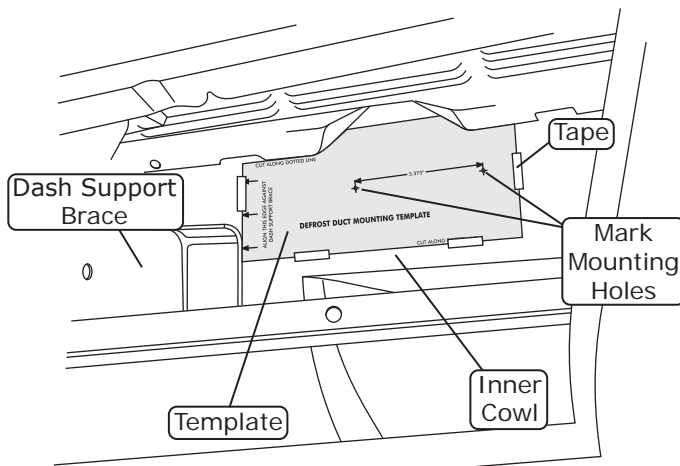

View Shown Through Glove Box Opening in Dash.

Figure 1

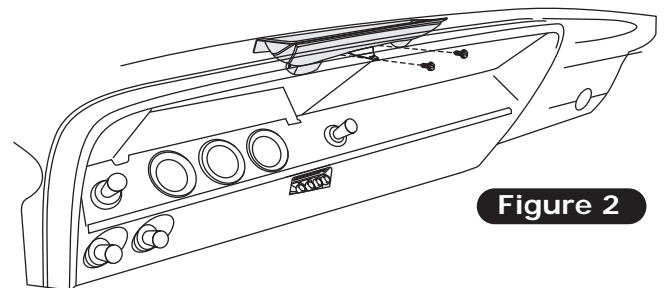

Figure 2

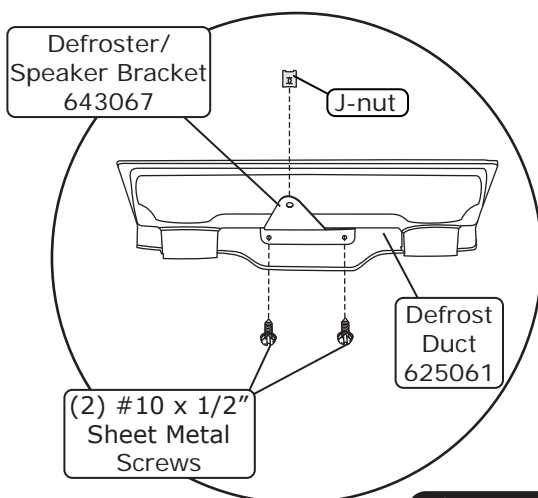

Figure 2a

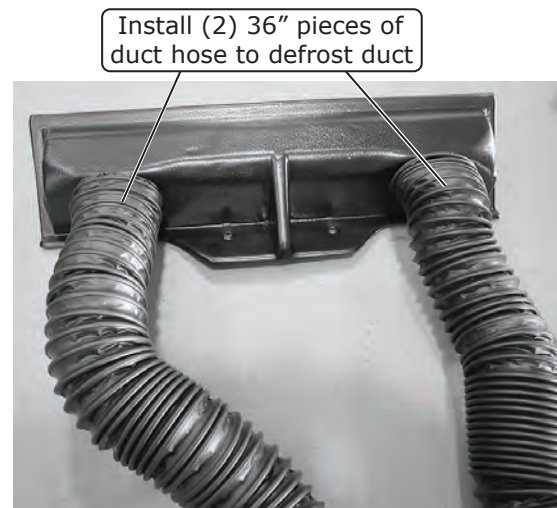

Photo 1



www.vintageair.com

Speaker Mounting

1. Using a #10 x 1/2" sheet metal screw, secure the speaker bracket to the bracket on the defrost duct (See Figure 1, below).

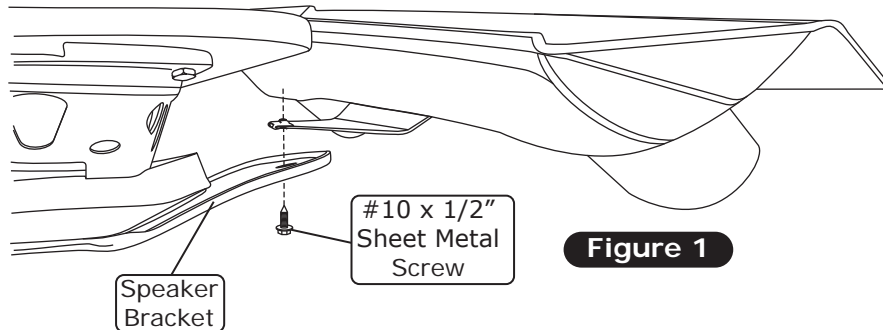

Kick Panel Modification

1. Remove the passenger-side kick panel (See Photo 1, below).
2. Remove the kick panel fresh air door assembly by removing (6) OEM screws (retain hardware) (See Photo 2, below).
3. Disconnect the pull cable assembly and the fresh air door from the housing (discard) (See Photos 3 and 4, below). **NOTE: Removal of tabs is optional.**
4. Drill out the OEM mounting rivets fastening the metal screen to the kick panel (See Photo 5, below).

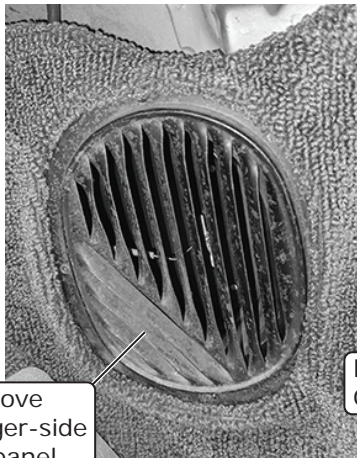

Photo 1

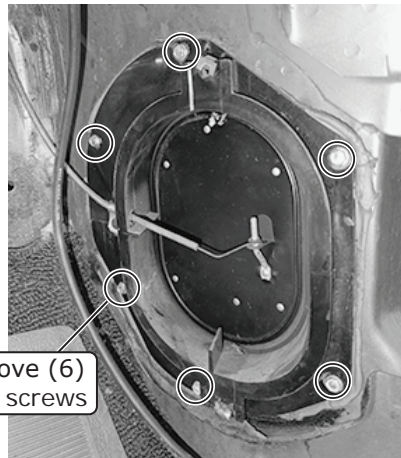

Photo 2

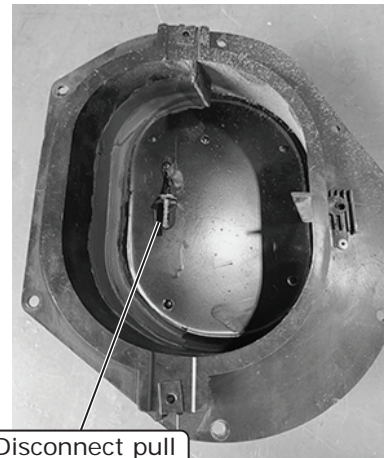

Photo 3

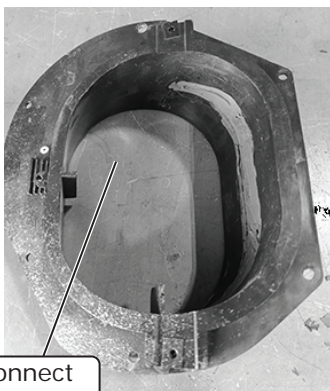

Photo 4

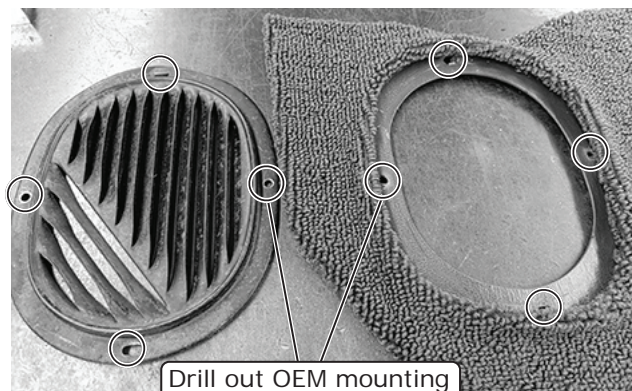

Photo 5



www.vintageair.com

Kick Panel Modification (Cont.)

5. Apply a bead of silicone to the mating surface of the kick panel opening (See Photo 6, below).
6. Reinstall the housing using OEM hardware (See Photo 7, below).
7. Reinstall the kick panel (See Photo 8, below).

Apply bead of silicone to mating surface of kick panel opening

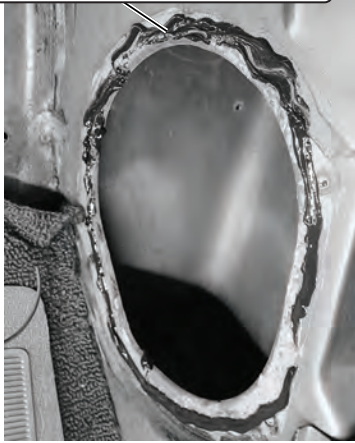
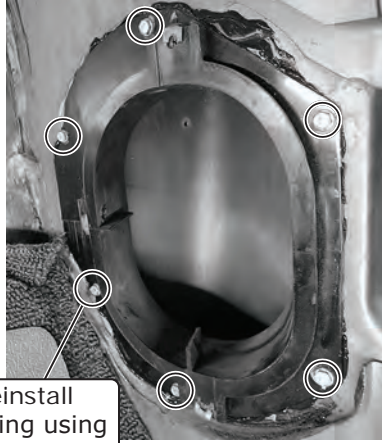
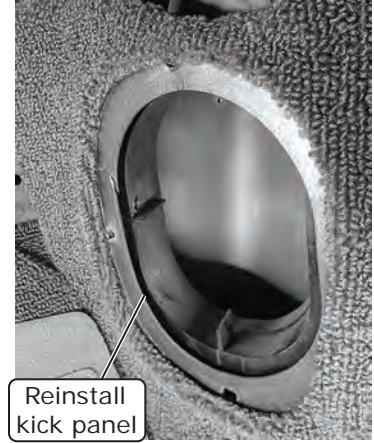

Photo 6



Reinstall housing using OEM hardware

Photo 7



Reinstall kick panel

Photo 8

Fresh Air & Kick Panel Cover Preparation

1. Install (3) large grommets, a 1 1/4" O.D. with 1/2" hole grommet and a 7/8" O.D. x 3/8" I.D. grommet into the fresh air cover and kick panel cover (See Photos 1 and 2, below). **NOTE: Check the orientation of the fresh air cover against the opening in the firewall before installing the grommets.**

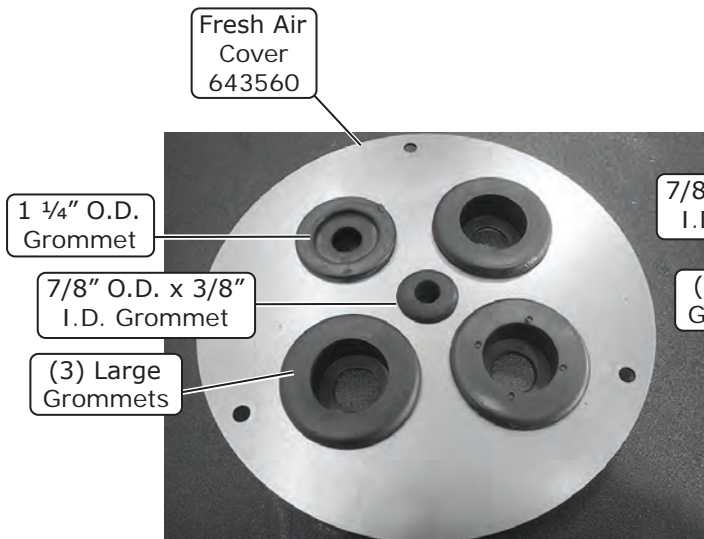

Photo 1

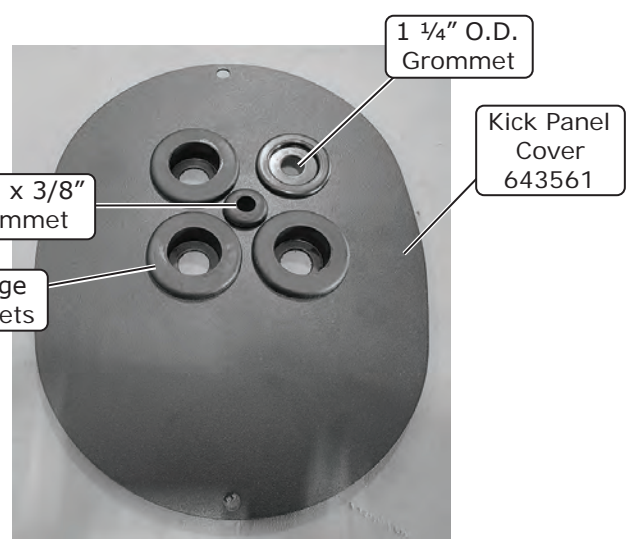
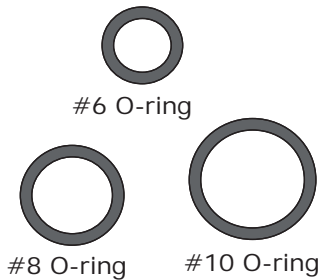

Photo 2



www.vintageair.com

Lubricating O-rings



NOTE: Standard torque specifications:
 #6: 11 to 13 ft-lb.
 #8: 15 to 20 ft-lb.
 #10: 21 to 27 ft-lb.

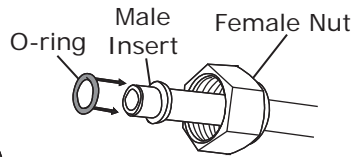

For a proper seal of fittings: Install supplied O-rings as shown and lubricate with refrigerant oil.

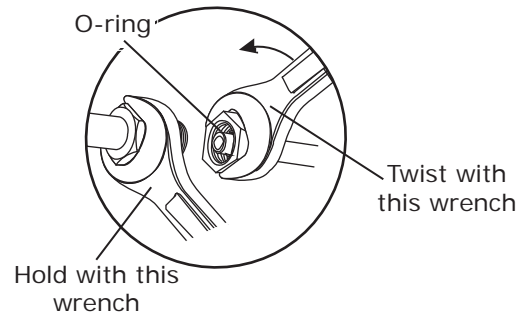
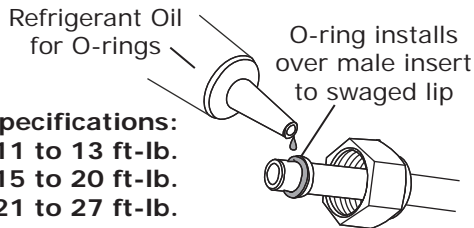

Properly Seated O-ring Land

When installing a hardline or A/C hose fitting onto the evaporator module, ensure the O-ring land is seated properly (See Photo 1, below). An improperly seated O-ring land (See Photo 2, below) can cause a leak. To properly install the fitting, slide the hardline or A/C hose nut back to expose the O-ring land and seat it onto the evaporator module fitting. Then, slide the hardline or A/C hose nut forward and thread it onto the evaporator module fitting, ensuring the O-ring land does not move or lift.

Properly Seated O-ring Land



Photo 1

Improperly Seated O-ring Land

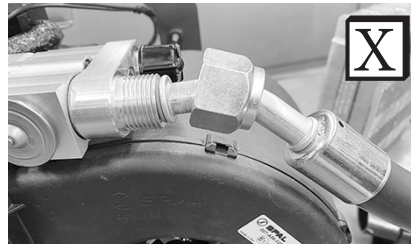

Photo 2

NOTE: Photos shown are for reference only. Fittings may vary depending on kit received.

Evaporator Module Preparation

Perform the following on a workbench:

1. Install (3) 1/2" plastic plugs into the back (See Photo 1, below) and (1) into the front of the evaporator module (See Photo 2, below). **NOTE: These mounting positions will not be used for this application.**

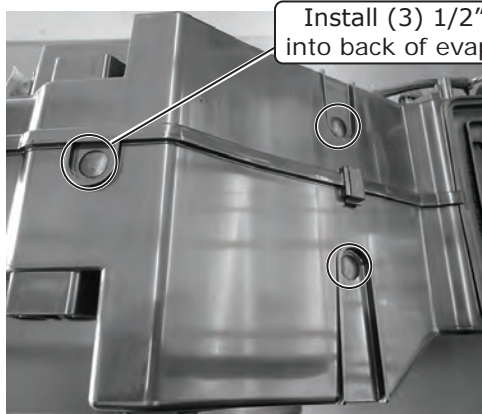

Install (3) 1/2" plastic plugs into back of evaporator module

Photo 1

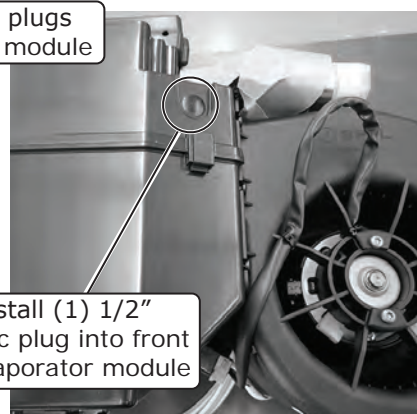

Install (1) 1/2" plastic plug into front of evaporator module

Photo 2



www.vintageair.com

Evaporator Module Preparation (Cont.)

2. Install the upper and lower 45° heater fittings onto the evaporator module using (2) properly lubricated #10 O-rings (See Lubricating O-rings, Page 12 and Photo 3, below).
3. Install the evaporator firewall bracket onto the module and secure it using (4) #10 x 5/8" screws (See Photo 4, below).
4. Install a 1/4-20 full-threaded stud into the lower mounting hole on the evaporator firewall bracket (See Photo 5, below).
5. Using (4) spring clips ((2) per side), install the dash plenum onto the evaporator module (See Photo 6, below).
6. Using (2) spring clips, install the defrost plenum onto the back of the evaporator module as shown in Photo 7, below.
7. Using (2) spring clips, install the floor plenum onto the front of the evaporator module (See Photo 8, below).

Install upper and lower 45° heater fittings

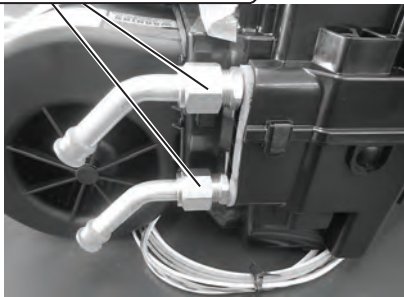
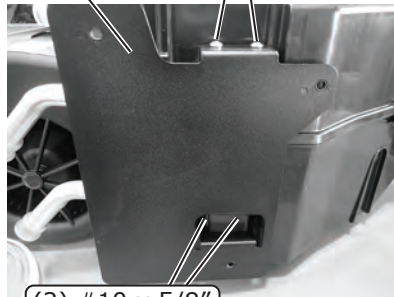

Photo 3

Evaporator Firewall Bracket 643572

(2) #10 x 5/8" Screws



(2) #10 x 5/8" Screws

Photo 4

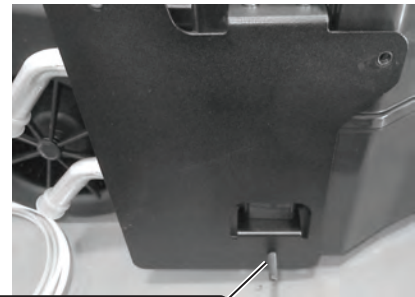

Install a 1/4-20 full-threaded stud

Photo 5

Using (2) spring clips per side, install dash plenum



Photo 6

Dash Plenum 625330

Defrost Plenum 625331



Using (2) spring clips, install defrost plenum

Photo 7

Using (2) spring clips, install floor plenum

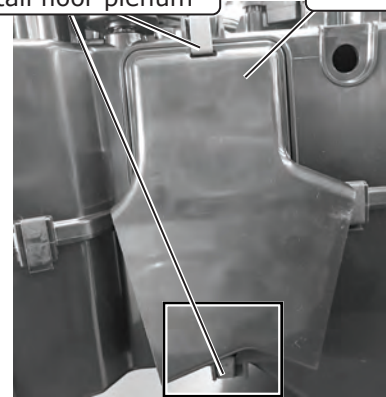

Photo 8

Floor Plenum 625340





www.vintageair.com

Wiring Installation

1. Locate the heater control valve plug on the main wiring harness (white/yellow/purple). Route it through the 7/8" wiring grommet on the kick panel cover (See Photo 1, below) and into the kick panel opening. Then, through the 7/8" wiring grommet on the fresh air cover and into the engine compartment (See Photo 2, below).
2. Route the red, white and blue wires from the main harness through the 7/8" wiring grommet on the kick panel cover (See Photo 3, below) and into the kick panel opening. Then, route the wires through the wiring grommet on the fresh air cover and into the engine compartment (See Photo 4, below).
3. Leave approximately 8" of wiring between the kick panel cover and relay.
4. Place the evaporator module on the passenger-side floorboard.
5. Route the heavy gauge orange and white wires through the wiring grommet on the kick panel cover and into the kick panel opening. Then, through the wiring grommet on the fresh air cover and into the engine compartment.

Kick Panel Cover
643561

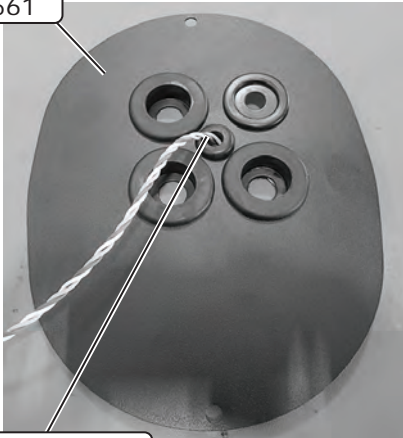

Route heater control valve wiring (white/yellow/purple) through 7/8" wiring grommet on kick panel cover

Photo 1

Fresh Air Cover
643560

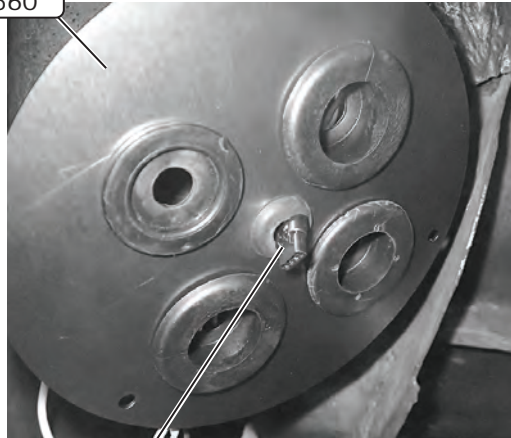

Route heater control valve wiring (white/yellow/purple) through 7/8" wiring grommet on fresh air cover

Photo 2



Route red, white and blue wires from main harness through 7/8" wiring grommet on kick panel cover

Photo 3



Route red, white and blue wires from main harness through 7/8" wiring grommet on fresh air cover and into engine compartment

Photo 4



www.vintageair.com

Kick Panel & Fresh Air Cover Installation

1. Route the A/C and heater hoses through the fresh air cover in the engine compartment into the passenger compartment (See Photos 1 and 2, below). Once hoses are routed into the passenger compartment apply a bead of silicone to the firewall opening. Install the fresh air cover using (3) #12 x 1/2" self-tapping screws (See Photo 2, below).
2. Route the A/C and heater hoses through the kick panel cover as shown in Photo 3, below.
3. Apply a 1/4" bead of silicone around the mating surface of the kick panel.
4. Install the kick panel cover onto the kick panel using (2) OEM screws (See Photo 4, below).

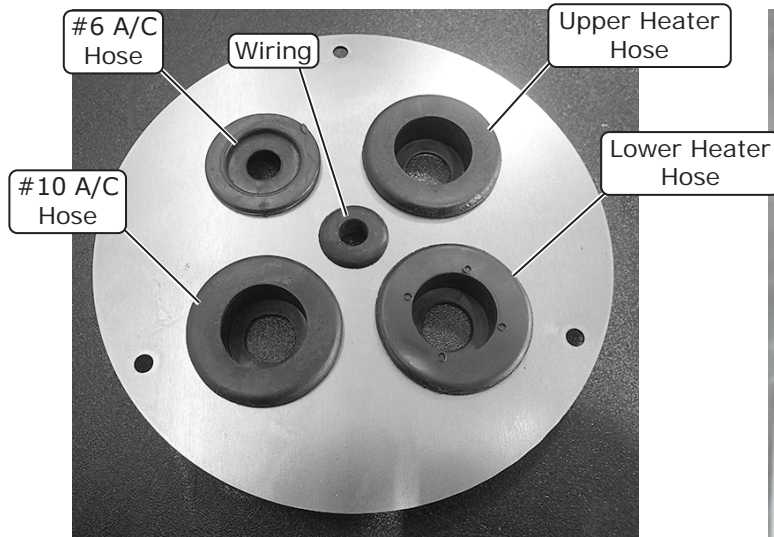

Photo 1



Route A/C and heater hoses through fresh air cover

Photo 2

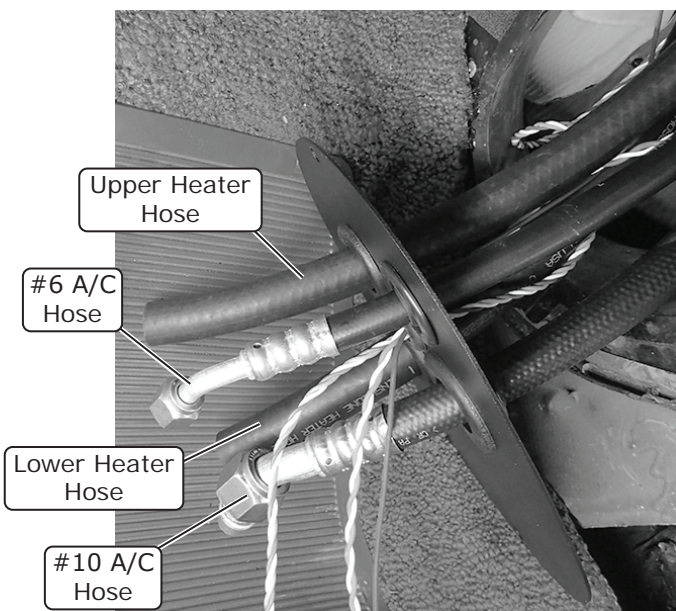

Photo 3

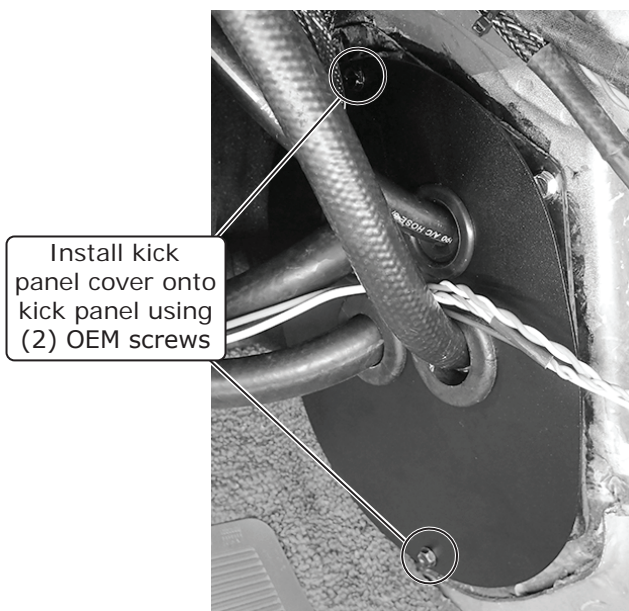

Photo 4



www.vintageair.com

Passenger Compartment Wiring

1. Select a suitable ground location for the white ground wire eyelet from the heater control valve harness and secure it using a #12 x 1/2" self-tapping screw.
2. Route the violet power wire to a switched 12v power source on the fuse panel (See Photo 1, below).
NOTE: This requires a male fuse extension (not supplied).
3. Connect the tan wire to the factory dash lights to enable control panel backlighting (if applicable).
4. Select a suitable mounting location for the main relay and secure using a #10 x 1/2" sheet metal screw.
5. Connect the BSC plug to the main wiring harness (See Photo 2, below).

Attach violet wire to switched power source



Photo 1

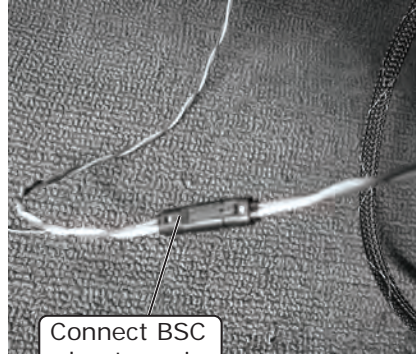

Connect BSC plug to main harness

Photo 2

Evaporator Installation

NOTE: To ensure a watertight seal between the passenger compartment and the vehicle exterior, for all bolts passing through the firewall, Vintage Air recommends coating the threads with silicone prior to installation.

1. With the evaporator module on the passenger-side floorboard, install the upper and lower heater hoses with hose clamps onto the upper and lower heater hardlines on the evaporator module (See Photo 1, below).
2. Using a properly lubricated #6 O-ring (See Lubricating O-rings, Page 12), install the 45° fitting on the #6 drier/evaporator A/C hose onto the #6 fitting on the block valve adapter on the evaporator module (See Photo 2, below). **NOTE: Provide enough A/C hose when connecting the 45° fitting to the module. Once the connection is made, pull excess hose into the engine compartment, being sure not to kink it.**

Install upper and lower heater hoses with hose clamps onto the upper and lower heater hardlines on evaporator module

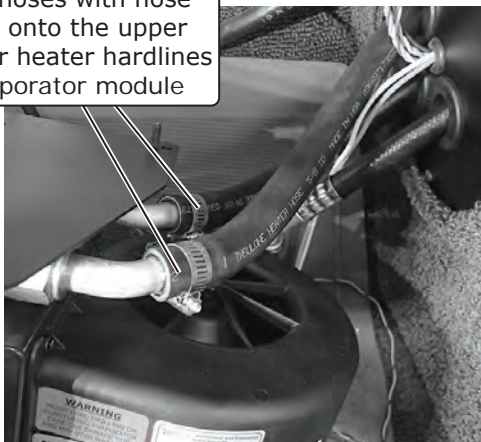

Photo 1

Install 45° fitting on #6 drier/evaporator A/C hose onto #6 fitting on block valve adapter

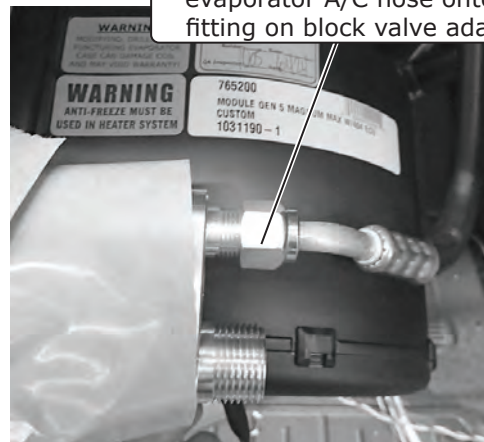

Photo 2



www.vintageair.com

Evaporator Installation (Cont.)

3. Using a properly lubricated #10 O-ring (See Lubricating O-rings, Page 12), install the 45° fitting on the #10 compressor/evaporator A/C hose onto the #10 fitting on the block valve adapter on the evaporator module (See Photo 3, below). **NOTE: After installing the #10 compressor/evaporator A/C hose, wrap all exposed metal with the supplied press tape (See Photo 3, below).**
4. Connect the main harness plug to the ECU (See Photo 4, below). Locate the control panel plug and connect it to the ECU (See Photo 5, below). **NOTE: Once the module is in place this step will be difficult.**
5. Roll the evaporator module into its mounting position and insert the 1/4-20 full-threaded stud into the lower mounting hole on the firewall cover (See Photo 6, below).
6. Install a 1/4-20 U-nut onto the dash support brace over the OEM hole (See Photo 7, below).
7. Install a 1/4-20 well nut into the front mounting provision of the evaporator module (See Photo 7, below).
8. Using a 1/4-20 x 1" serrated flange bolt, loosely secure the evaporator front bracket to the evaporator module (See Photo 8, below).
9. Using a 1/4-20 x 3/4" serrated flange black bolt secure the evaporator dash bracket to the 1/4-20 U-nut in the dash brace (See Photo 9, below).
10. From the engine compartment, install (3) 1/4-20 x 3/4" serrated flange black bolts replacing the 1/4-20 full-threaded stud (See Photo 10, below).
11. Tighten all mounting hardware.

Wrap all exposed metal with supplied press tape

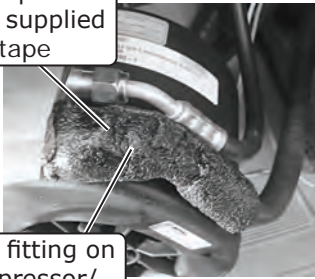

Photo 3

Install 45° fitting on #10 compressor/evaporator A/C hose onto #10 fitting on block valve adapter



Connect main harness to ECU

Photo 4

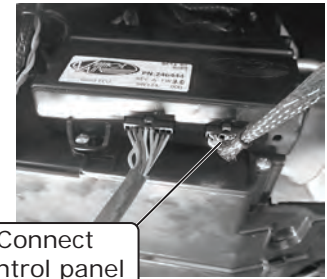

Connect control panel plug to ECU

Photo 5

Install 1/4-20 U-nut onto dash support brace over OEM hole

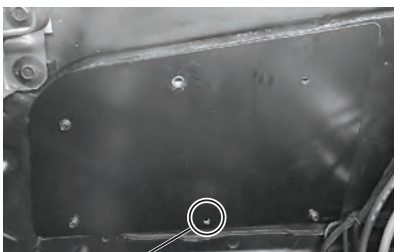

Insert 1/4-20 full-threaded stud into lower mounting hole

Photo 6

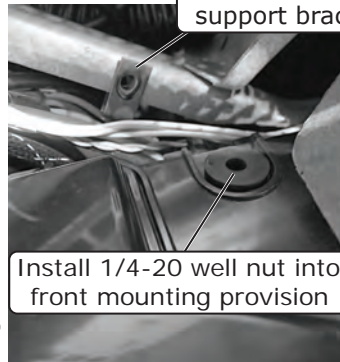

Install 1/4-20 well nut into front mounting provision

Photo 7

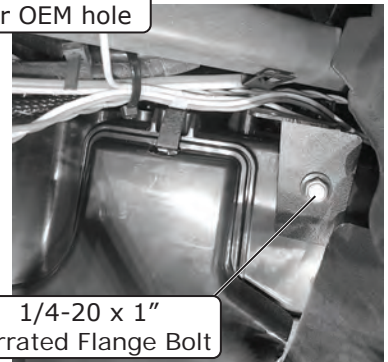

1/4-20 x 1" Serrated Flange Bolt

Photo 8

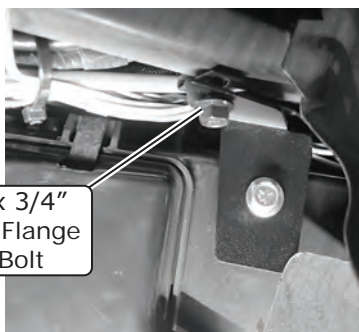

1/4-20 x 3/4" Serrated Flange Black Bolt

Photo 9

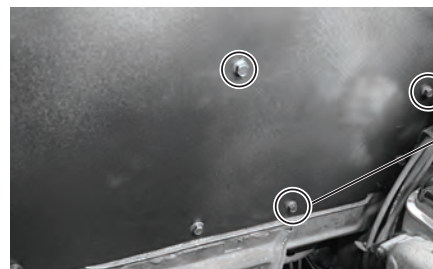

Install (3) 1/4-20 x 3/4" serrated flange black bolts

Photo 10



www.vintageair.com

Drain Hose Installation

1. Locate the evaporator drain on the bottom of the evaporator module.
2. In line with the drain, lightly make a mark on the firewall. Measure 2" down and 2 1/2" to the left, then drill a 5/8" hole through the firewall (See Figure 1, below).
3. Install the drain hose onto the outlet on the bottom of the evaporator module, then route it through the firewall (See Figure 1, below).

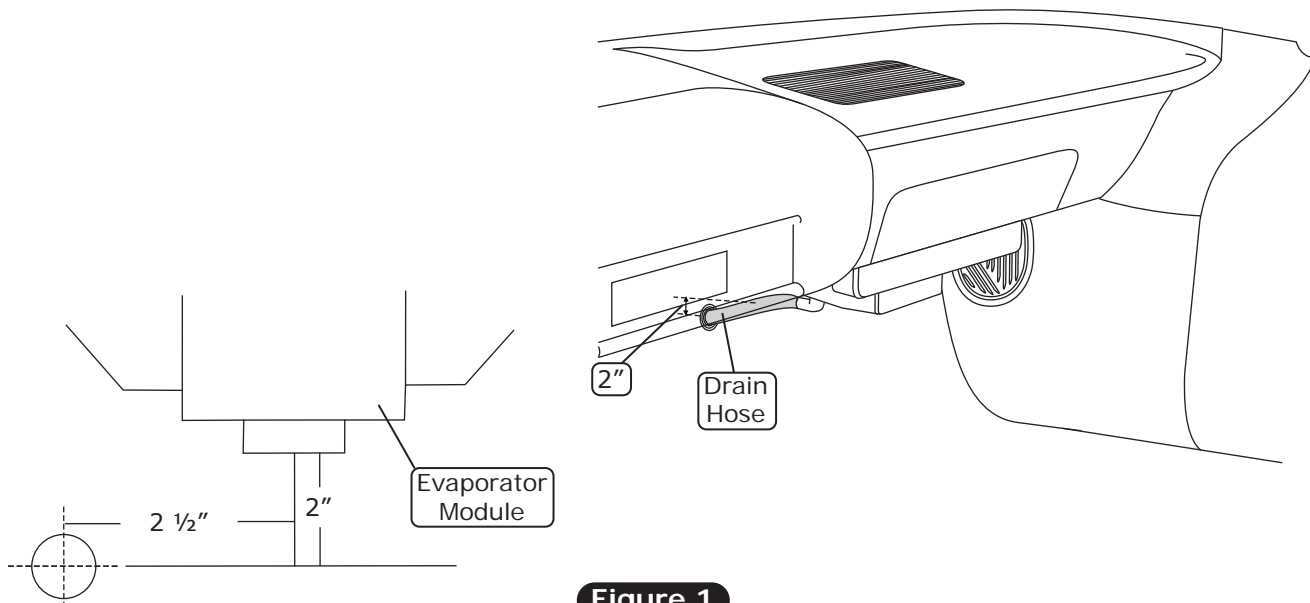

Figure 1

Driver-Side Under Dash Louver Mounting Holes

1. Cut out the template provided on Page 32. Place the template under the dash on the driver side by aligning the left side of the template against the edge of the dash as shown in Figure 1, below. Make sure the OEM holes line up with the holes on the template as shown in Figure 1, below.
2. Once the template is aligned correctly and taped into place, mark the mounting holes on the dash. Once the holes are marked in the correct location, drill (2) 3/16" holes into the dash for the driver-side louver bezel (See Figure 1, below).

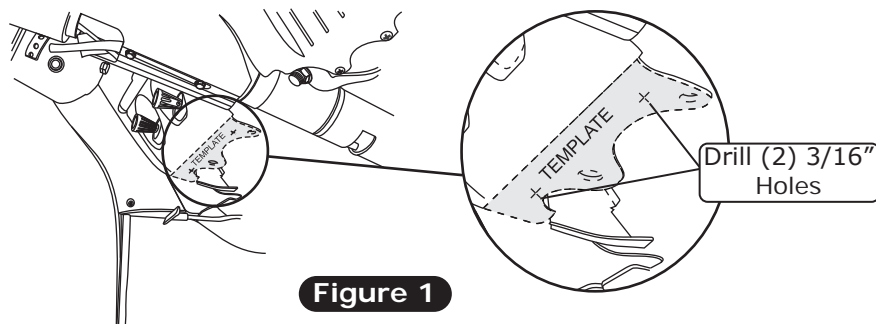

Figure 1



www.vintageair.com

Passenger-Side Under Dash Louver Mounting Holes

1. Using the (2) OEM dimples under the dash, drill (2) 3/16" holes in the dash as shown in Figure 1, below.

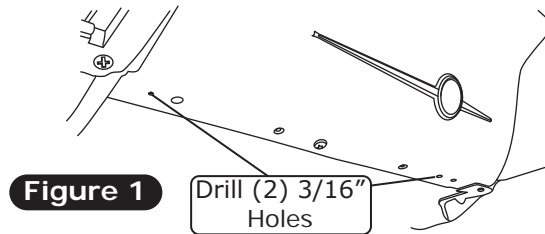

Driver-Side Under Dash Louver Installation

1. Place the louver bezel under the dash, and align it with the 3/16" holes in the dash.
2. Secure the louver bezel under the dash using (2) 10-24 x 3/8" pan head screws and (2) 10-24 nuts with star washers (See Figure 1, below).
3. Install the louver into the under dash bezel as shown in Figure 1a, below.

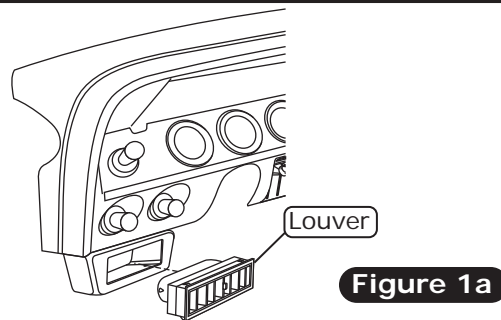
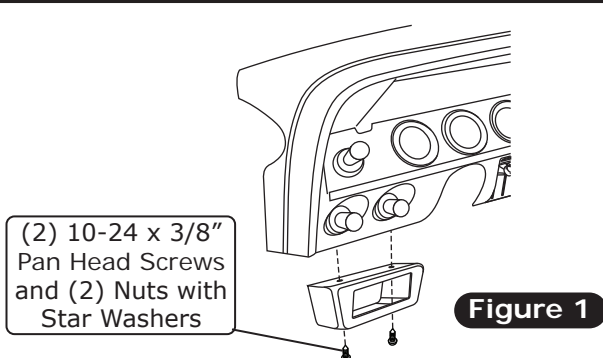

Center/Passenger-Side Under Dash Louver Installation

1. Place the louver bezel under the dash, and align it with the OEM holes in the dash.
2. Secure the louver bezel under the dash using (3) 10-24 x 3/8" pan head screws and (3) 10-24 nuts with star washers (See Figure 1, below).
3. Install the louvers into the under dash bezel as shown in Figure 1a, below.

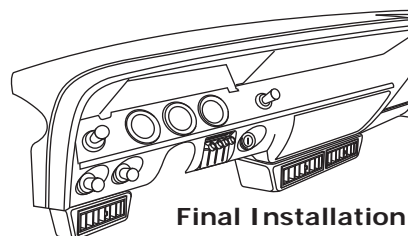
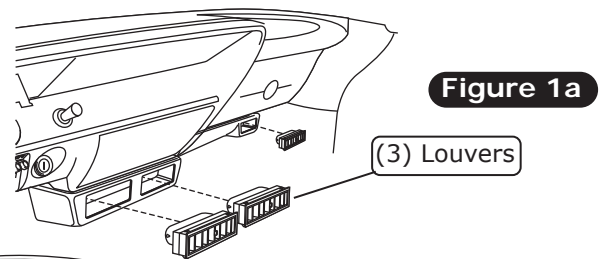
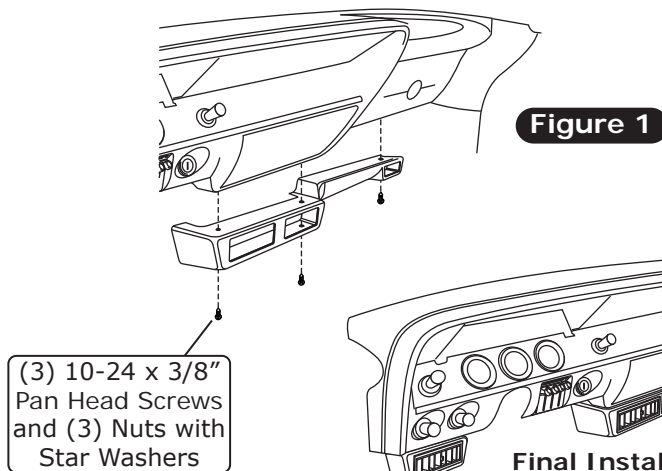



www.vintageair.com

Heater Hose & Heater Control Valve Installation

NOTE: Vintage Air systems use 5/8" heater connections. On engines equipped with 3/4" hose nipples, these will need to be removed and replaced with 5/8" nipples (not supplied). For water pumps with a cast-in 3/4" heater outlet, a 3/4" x 5/8" reducer fitting (not supplied) or molded hose will need to be installed in the heater hose.

1. Route the lower heater hose to the water pump fitting, then secure it using the supplied hose clamp (See Photo 1, below).
2. Cut the upper heater hose 4 to 5 inches from the fresh air cap and install the heater control valve into the upper heater hose. Secure the heater control valve using the supplied hose clamp (See Photo 2, below).

NOTE: Ensure proper flow direction through the heater control valve. The flow direction follows the molded arrow on the valve (See Figure 1, below).

Route lower heater hose to water pump fitting, then secure it using supplied hose clamp

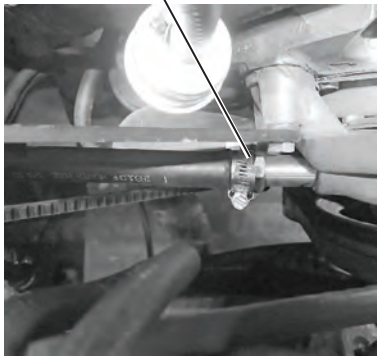

Photo 1

Install heater control valve into upper heater hose

Secure using supplied hose clamp

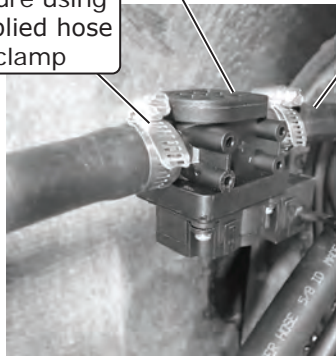

Photo 2

Cut heater hose 4" to 5" from fresh air cap

From Heater Control Valve to Heater Core

Heater Hose

NOTE: Flow Direction Follows Molded Arrow on Valve

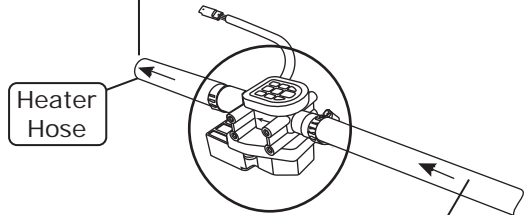

Figure 1

From Intake Manifold

A/C and Heater Hose Routing

NOTE: All hoses are designed to route under the battery tray.

1. With a properly lubricated #10 O-ring (See Lubricating O-rings, Page 12), connect the 135° fitting of the #10 A/C hose to the suction port of the compressor (See Photo 1, below).
2. With properly lubricated #8 O-ring (See Lubricating O-rings, Page 12), connect the #8 135° fitting to the discharge port of the compressor (See Photo 1, below).
3. With a properly lubricated #8 O-ring (See Lubricating O-rings, Page 12), connect the straight fitting of the #8 A/C hose to the #8 condenser hardline (See Photo 2, below).
4. With a properly lubricated #6 O-ring (See Lubricating O-rings, Page 12), connect the 45° fitting of the #6 A/C hose to the #6 condenser hardline (See Photo 2, below).

Connect #10 135° fitting to suction port of compressor

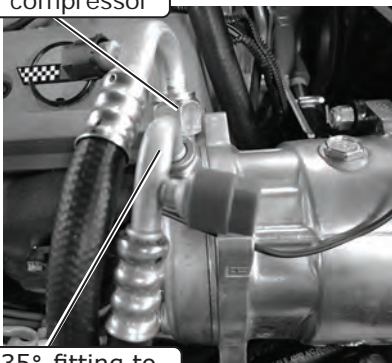

Connect #8 135° fitting to discharge port of compressor

Photo 1

Connect straight fitting of #8 A/C hose to #8 condenser hardline

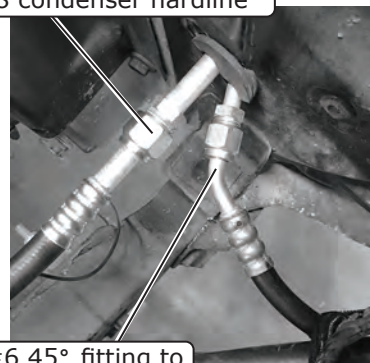

Connect #6 45° fitting to #6 condenser hardline

Photo 2



www.vintageair.com

Inner Fender Installation

1. Route the A/C heater hoses and wiring through the open area of the fender well toward the battery area.
2. Reinstall the inner fender using OEM bolts.
3. Reinstall the battery tray.

Engine Compartment Wiring

NOTE: The following connections are critical to the performance of the system. Before making connections, refer to the Quality Crimp Guidelines, Page 26.

1. Route power and ground wires toward the battery (See Photo 1, below).
2. Install the supplied heat shrink over the 12 AWG orange standard fuse holder assembly wire and crimp it to the 12 AWG orange wire from the main wiring harness (See Photo 2, below). Slide the heat shrink over the crimp, then apply heat.
3. Install the supplied heat shrink over the 16 AWG black mini fuse holder assembly wire and crimp it to the 16 AWG red wire from the main wiring harness (See Photo 3, below). Slide the heat shrink over the crimp, then apply heat.
4. Install the fuses into the holders (See Photos 4 and 5, below).
5. Install the supplied heat shrink over the white ground wires, then crimp on the supplied ring terminals (See Photo 6, below). Slide the heat shrink over the crimps, then apply heat. **NOTE: Both white wires can be crimped to the larger ring terminal. Install the heat shrink, then strip the wires, twist them together and trim to length. Crimp on the ring terminal, then slide the heat shrink over and apply heat (See Photos 7 and 8, below).**

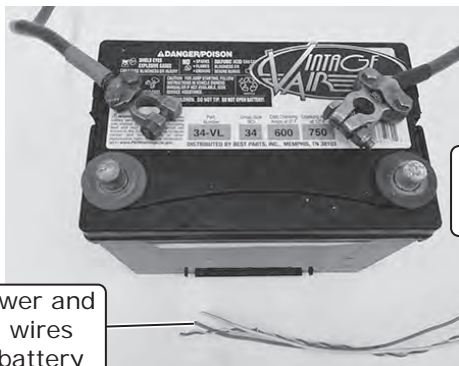

Route power and ground wires toward battery

Photo 1

Crimp 12 AWG orange fuse holder wire to 12 AWG orange wire from main wiring harness



Photo 2

Install heat shrink over 12 AWG orange standard fuse holder assembly wire

Crimp 16 AWG black fuse holder wire to 16 AWG red wire from main wiring harness



Photo 3

Install heat shrink over 16 AWG black standard fuse holder assembly wire

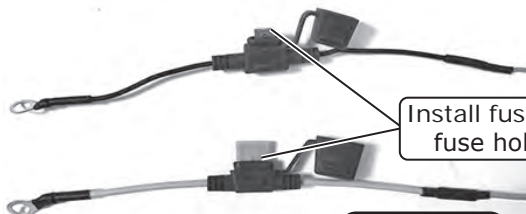

Install fuses into fuse holders

Photo 4

Install heat shrink over white ground wires, then crimp on ring terminals

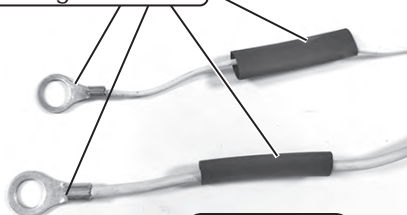

Photo 6



Both white ground wires can be crimped together. Install heat shrink, then strip wires, twist together and trim to length.

Photo 5

Crimp on ring terminal, then slide heat shrink over and apply heat



Photo 7

Photo 8



www.vintageair.com

Engine Compartment Wiring (Cont.)

6. Connect the ground wire ring terminals to the negative battery terminal connector (See Photos 9 and 10, below).
7. Connect the positive wire ring terminals to the positive battery terminal connector (See Photos 11 and 12, below). **NOTE: Do not connect power until the installation is completed.**
8. Wiring completed (See Photo 13, below).

Connect ground wire ring terminals to negative battery terminal
NOTE: Either connection application can be used.

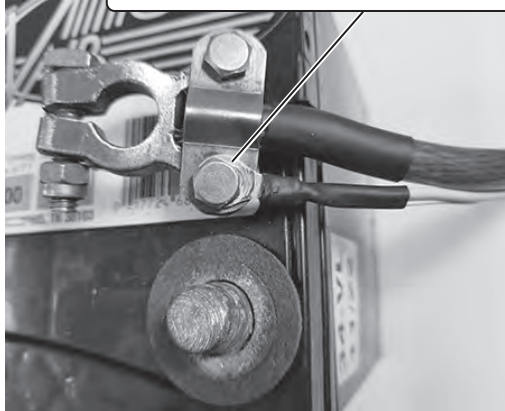

Photo 9



Photo 10

Connect power wire ring terminals to positive battery terminal
NOTE: Either connection application can be used.

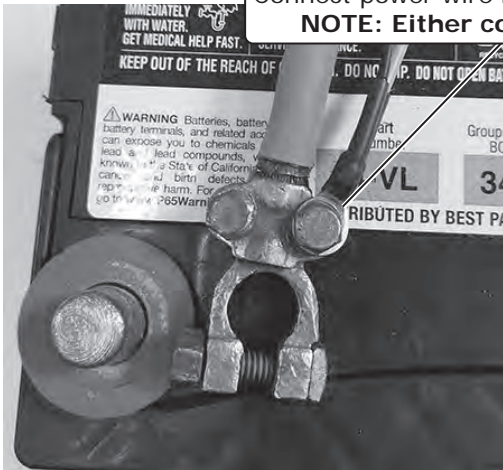
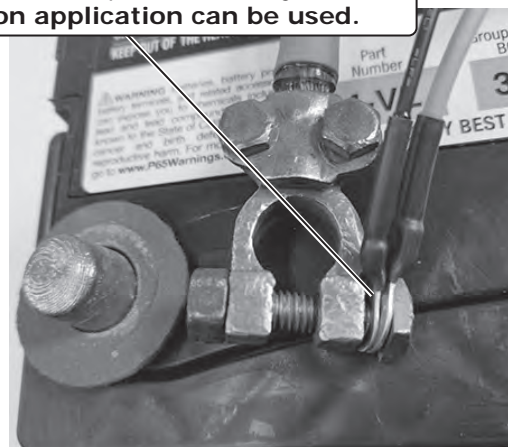

Photo 11



NOTE: Do not connect power until installation is completed.

Photo 12



Completed Installation Shown

Photo 13



www.vintageair.com

Final Steps: Installation Check

Installation Check	
ITEM TO CHECK	Procedure
<input type="checkbox"/>	<p>ECU</p> <p>If no blinking is observed after 1 minute of turning the ignition on, go to the next check.</p> <p>If repetitive blinking is observed, go to the Advanced Diagnostics Section to diagnose.</p>
<input type="checkbox"/>	<p>Blower speed control</p> <p>Set the blower speed control to OFF, <u>confirm that the blower is off</u>.</p> <p>Position the blower speed control to LOW then MEDIUM and then HIGH. <u>At each setting confirm that the blower speed increases</u>, do this by feeling for the amount of air coming from the unit and hearing the blower speed increase.</p>
<input type="checkbox"/>	<p>Mode control</p> <p>Set the MODE control to the DASH position. <u>Confirm that air is being blown at the dash vents</u>.</p> <p>Set the MODE control to the FLOOR position. <u>Confirm that air is being blown at the floor vents</u>.</p> <p>Set the MODE control to the DEFROST position. <u>Confirm that all air is being blown from the defrost vents</u></p> <p>If heater lines are installed:</p> <p>Set the MODE control to the DASH position. Set the TEMP control to the MAX HEAT position. <u>Confirm that HOT air is coming from the dash vents</u>.</p>
<input type="checkbox"/>	<p>Temperature control</p> <p>If system is charged:</p> <p>Set the TEMP control to the MAX COOL position. <u>Confirm that COLD air is coming from the dash vents</u>.</p> <p>Also <u>confirm that the compressor "clicks" on</u> when adjusting the TEMP control from the MAX HEAT position to the MAX COOL position.</p>
<input type="checkbox"/>	<p>AC Indicator (If applicable)</p> <p>While the MODE control is set to the DASH position, and the TEMP control is set to the MAX COOL/MIN HEAT position, <u>confirm that the blue AC Indicator light is on</u>.</p>
<input type="checkbox"/>	<p>Backlight (If applicable)</p> <p>If your control panel has backlight capabilities and has been wired, turn the dash lamp on and <u>confirm that the AC panel's legend is lit</u>.</p>
<input type="checkbox"/>	<p>Fittings</p> <p>Verify AC and Heater fittings are all tight.</p>



www.vintageair.com

Final Steps: Completing the Install

1. Install duct hoses according to Duct Hose Routing, Page 25.
2. Install control panel assembly. Refer to control panel instructions.
3. Install supplied glove box, and secure using (3) OEM screws through the OEM holes as shown in Figure 1, below.
4. Reinstall glove box door using OEM hardware.
5. Reinstall all previously removed items.
6. Fill radiator with at least a 50/50 mixture of approved antifreeze and distilled water. It is the owner's responsibility to keep the freeze protection at the proper level for the climate in which the vehicle is operated. Failure to follow antifreeze recommendations will cause heater core to corrode prematurely and possibly burst in A/C mode and/or freezing weather, voiding your warranty.
7. Double check all fittings, brackets and belts for tightness.
8. Vintage Air recommends that all A/C systems be serviced by a licensed automotive A/C technician.
9. Evacuate the system for a minimum of 45 minutes prior to charging, and perform a leak check prior to servicing.
10. Charge the system to the capacities stated on Page 4 of this instruction manual.
11. See Operation of Controls procedures on Page 29.

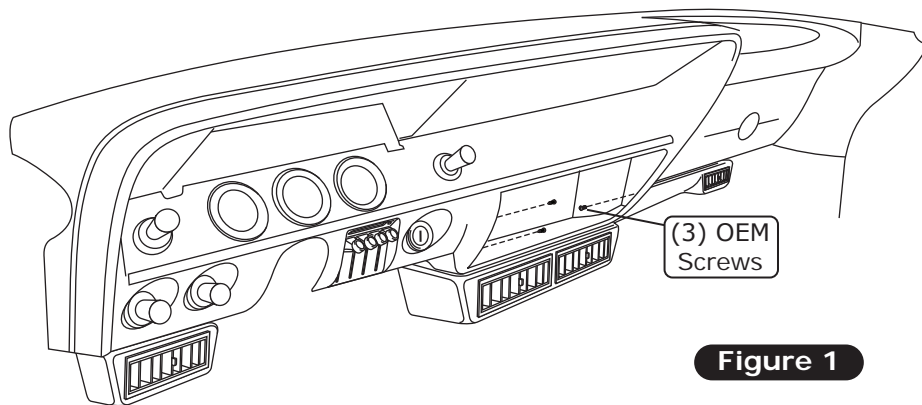

Figure 1



www.vintageair.com

Duct Hose Routing

NOTE: For the system to function optimally, the duct hoses must be routed as directly as possible, taking care to avoid kinks, sharp bends and unnecessary length. Vintage Air supplies duct hoses in continuous lengths that will need to be cut to size depending on application. Before cutting, familiarize yourself with the installation instructions and verify the routing will work with your application. For custom hose routing, additional hose may be needed and can be purchased from Vintage Air.

1. Stretch the duct hose until there is no slack, measure, mark and cut hose to size (See Photo 1, below).

Stretch, measure, mark and cut hose to size

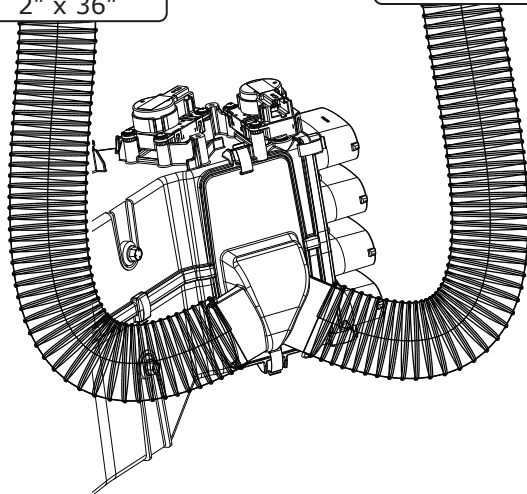

Photo 1

Disclaimer: Before cutting duct hose to length, verify the routing will work for your application.

Passenger-Side Defrost Duct
2" x 36"

Driver-Side Defrost Duct
2" x 36"



Passenger-Side Louver
2 1/2" x 43"

Driver-Side Louver
2 1/2" x 36"

Driver-Side Center Louver
2 1/2" x 12"

Passenger-Side Center Louver
2 1/2" x 12"

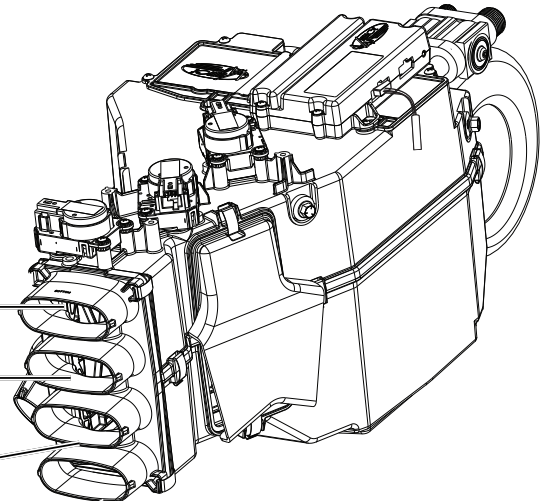

NOTE: ECU must be placed away from water and humidity, and also be accessible for servicing. If relocating, connectors must be positioned towards the bottom.

Position connectors towards bottom



www.vintageair.com

Quality Crimp Guideline

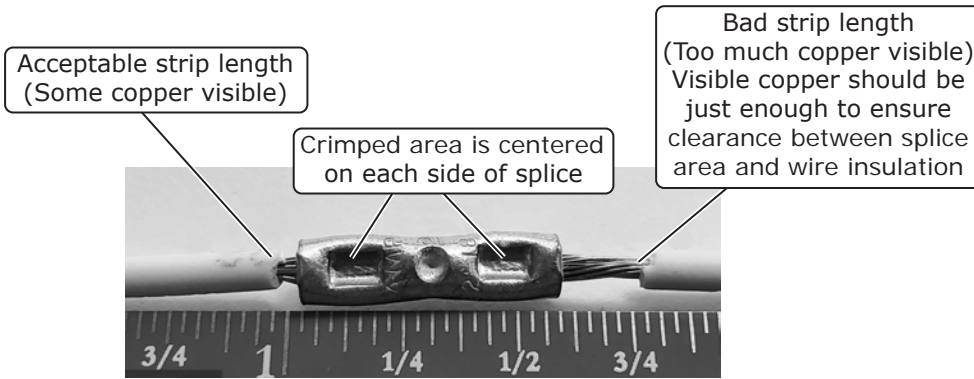

Photo 1

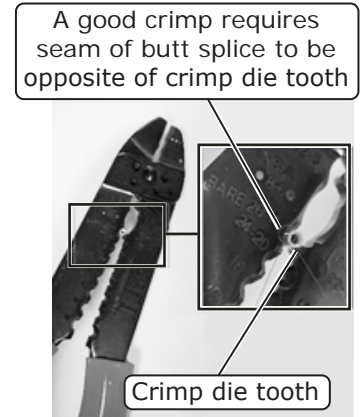

Photo 2

Good Ring Terminal Crimp Bad Ring Terminal Crimp



Photo 3

Crimp area is centered on barrel

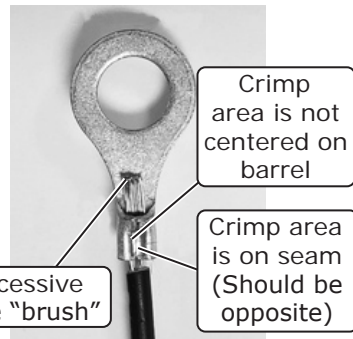

Photo 4



Photo 5

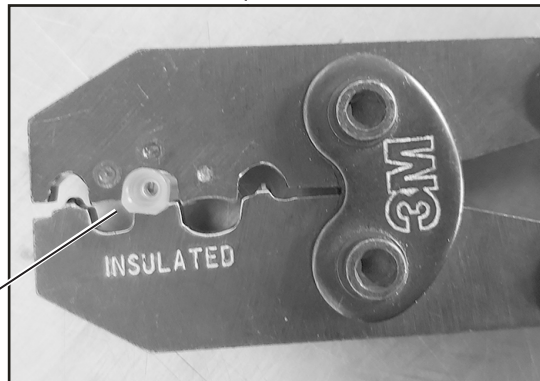

Photo 5a

Use a ratcheting crimp tool for insulated barrel terminals when crimping the provided female insulated terminal. Ensure terminal is inserted in appropriate position before crimping.



www.vintageair.com

Gen 5 Wiring Diagram

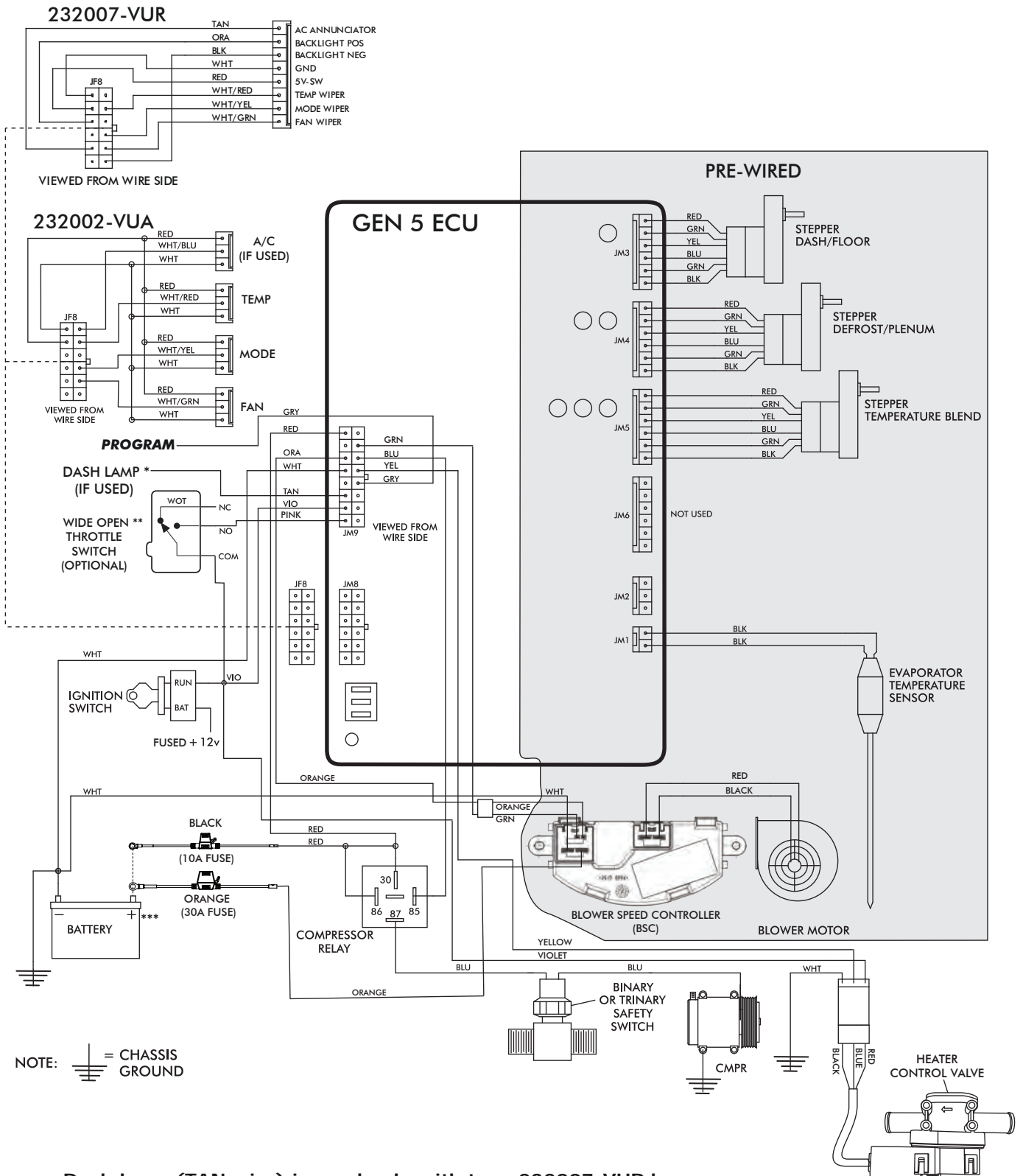

NOTE: = CHASSIS GROUND

- * Dash lamp (TAN wire) is used only with type 232007-VUR harness.
- ** Wide open throttle switch contacts close only at full throttle, which disables A/C compressor.
- *** Install fuse assemblies at or as near to the battery as possible.



www.vintageair.com

Gen 5 Wiring Instructions

WIRING HARNESS (231505) ↓

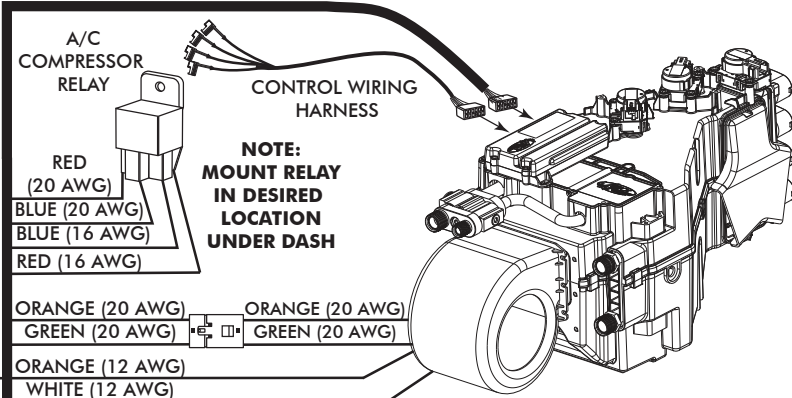

NOTE:
MOUNT RELAY
IN DESIRED
LOCATION
UNDER DASH

Ignition Switch:
Using provided butt splice (PN 226004), connect the 20 AWG violet wire to a 5A fused and switched 12V source such as Key On.

Wide Open Throttle Switch (Optional):
If a wide open throttle switch is required, connect the 20 AWG pink wire to a normally open switch that, when closed, connects a fused and switched 12V source to the pink wire. See Gen 5 wiring diagram for an example.

Dash Light (Optional):
If using a Vintage Air control panel with back light, connect the 20 AWG tan wire to the vehicle's dash back light 0-12V using provided butt splice (PN 226004).

WIRING HARNESS (232020) →

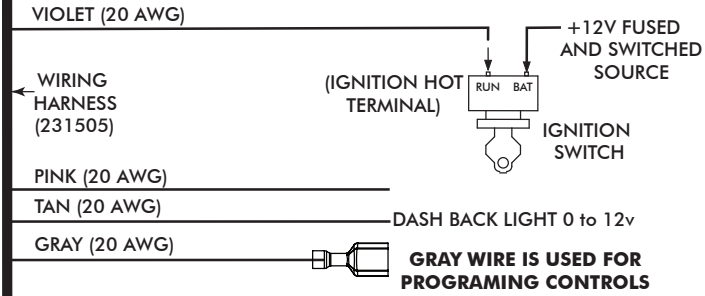

GRAY WIRE IS USED FOR PROGRAMING CONTROLS IF APPLICABLE

FIREWALL

FIREWALL

WIRING HARNESS (232020) →

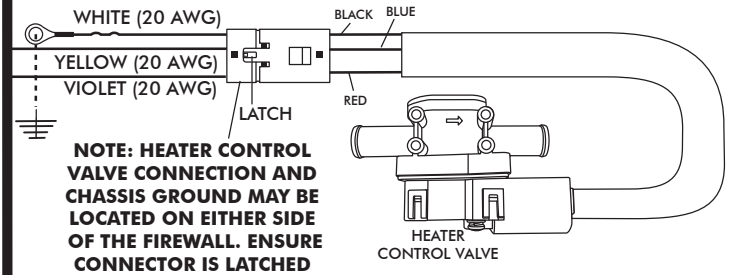

NOTE: HEATER CONTROL VALVE CONNECTION AND CHASSIS GROUND MAY BE LOCATED ON EITHER SIDE OF THE FIREWALL. ENSURE CONNECTOR IS LATCHED FIRMLY.

Heater Control Valve:
Connect the Violet/Yellow/White twisted branch with 3 position connector into the heater control valve connector. Ensure that the mating latch is fully seated.

Binary/Trinary & Compressor:
Binary Switch: Terminate provided insulated female terminal (PN 23172-VUW) to the blue 16 AWG wire. Connect as shown.
Trinary Switch: Connect according to trinary switch wiring diagram.

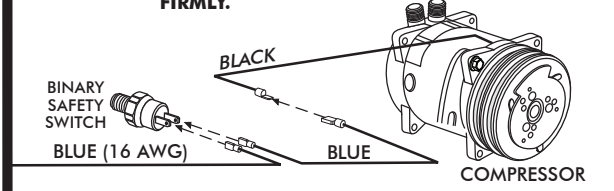

NOTE: CONNECT WHITE WIRES DIRECTLY TO (-) BATTERY TERMINAL

Battery Connections:
ECU Ground: Terminate provided ring terminal (PN 226110) to 20 AWG white wire from the 231505 wire assembly and install at battery.
ECU PWR: Terminate provided fuse assembly with black leads (PN 233012) to the 16 AWG red wire from the 231505 wire assembly. Install provided 10A Red Mini Fuse (PN 226118). Install at battery.
Blower Speed Controller (BSC) Ground: Terminate provided ring terminal (PN 226111) to 12 AWG white wire from the 232020 wire assembly and install at battery.
Blower Speed Controller (BSC) PWR: Terminate provided fuse assembly with orange leads (PN 233008) to the 12 AWG orange wire from the 232020 wire assembly. Install provided 30A Green ATO/ATC Fuse (PN 226125). Install at battery.

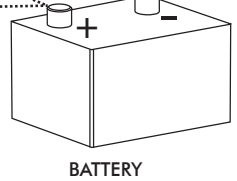



www.vintageair.com

Operation of Controls

On Gen IV or Gen 5 systems with three lever/knob controls, the temperature control toggles between heat and A/C operations. To activate A/C, move the temperature lever/knob all the way to cold and then back it off to the desired vent temperature. For heat operation, move the temperature lever/knob all the way to hot and then adjust to the desired vent temperature. The blower will momentarily change speed, each time you toggle between operations, to indicate the change. **NOTE: For proper control panel function, refer to control panel instructions for calibration procedure.**

Blower Speed

This lever/knob controls blower speed, from OFF to HI.

Mode Control

This lever/knob controls the mode positions, from DASH to FLOOR to DEFROST, with a blend in between.

Temperature Control

This lever/knob controls the temperature, from HOT to COLD.

NOTE: Original blower switch will not be used.

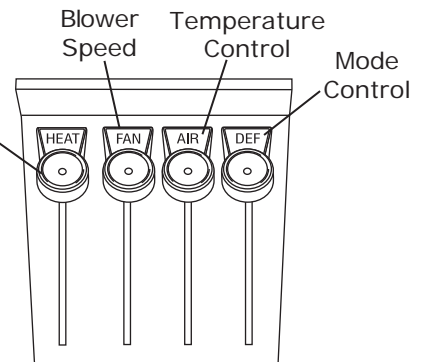

A/C Operation

Blower Speed

Adjust to desired speed.

Mode Control

Adjust to desired mode position (DASH position recommended).

Temperature Control

For A/C operation, adjust to coldest position to engage compressor (Adjust between HOT and COLD to reach desired temperature).

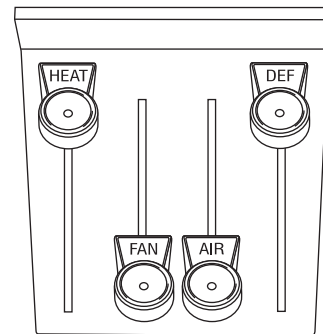

Heat Operation

Blower Speed

Adjust to desired speed.

Mode Control

Adjust to desired mode position (FLOOR position recommended).

Temperature Control

For maximum heating, adjust to hottest position (Adjust between HOT and COLD to reach desired temperature).

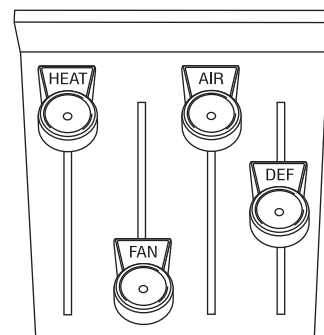

Defrost/De-fog Operation

Blower Speed

Adjust to desired speed.

Temperature Control

Adjust to desired temperature.

Mode Control

Adjust to DEFROST position for maximum defrost, or between FLOOR and DEFROST positions for a bi-level blend (Compressor is automatically engaged).

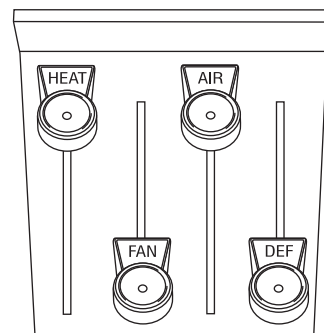



www.vintageair.com

Troubleshooting Guide

This printed troubleshooting guide is our basic guide that covers common installation problems. To see our advanced diagnostics and troubleshooting guide, please refer to the following page for instructions on how to download the complete guide.

WARNING: While troubleshooting the system, never probe connector terminals from the front mating side, only back probe.

WARNING: While troubleshooting the system, never use automotive check lights.

Symptom	Condition	Checks	Actions	Notes
1. Blower stays on high speed with ignition on.	No other functions work.	Check for damaged pins or wires in the control panel wire assembly and mating header at ECU.	If found damaged, replace wire assembly or ECU.	If fuse continues to blow, there is a serious problem in the wiring. Check all wiring and ensure the wire is not damaged and shorting out along its route.
	All other functions work.	Check for a bad ECU GND. Check for damaged pins or wires in the control panel wire assembly and mating header at ECU. Check if Blower power fuse is blown. Check for a bad ECU GND.	If found damaged, replace wire assembly or ECU. Replace fuse. Repair connection.	
2. Compressor will not turn on (All other functions work).	System is not charged.	System must be charged for compressor to engage.	Charge system.	Danger: Never bypass safety switch with engine running. Serious injury can result.
	System is charged.	Check for faulty A/C potentiometer or associated wiring (not applicable to 3-pot controls). Check for disconnected or faulty thermistor.	Check continuity to ground on white control head wire. Check for 5V on red control head wire. Check 2-pin connector at ECU housing.	To check for proper pot function, check voltage at white/red wire. Voltage should be between 0V and 5V, and will vary with pot lever position. Disconnected or faulty thermistor will cause compressor to be disabled.
	Compressor will not turn off (All other functions work).	Check for faulty A/C potentiometer or associated wiring.	Repair or replace pot/control wiring.	Red wire at A/C pot should have approximately 5V with ignition on. White wire will have continuity to chassis ground. White/Red wire should vary between 0V and 5V when lever is moved up or down.
3. Compressor will not turn off (All other functions work).	System is charged.	Check for faulty A/C relay.	Replace relay.	



www.vintageair.com

Troubleshooting Guide (Cont.)

Symptom	Condition	Checks	Actions	Notes
4. System will not turn on, or runs intermittently.	Works when engine is not running; shuts off when engine is started	Noise interference from either ignition or alternator.	Install capacitors on ignition coil and alternator. Ensure good ground at all points. Relocate coil and associated wiring away from ECU and ECU wiring. Check for burned or loose plug wires.	Ignition noise (radiated or conducted) will cause the system to shut down due to high voltage spikes. If this is suspected, check with a quality oscilloscope. Spikes greater than 16V will shut down the ECU. Install a radio capacitor at the positive post of the ignition coil (see radio capacitor installation bulletin). A faulty alternator or worn out battery can also result in this condition.
	Will not turn on under any conditions.	Verify connections on power lead, ignition lead, and both white ground wires. Verify battery voltage is greater than 10 volts and less than 16 while engine is running.	Check for power at ECU, and confirm ignition is being applied to ECU properly. Verify proper meter function by checking the condition of a known good battery.	
5. Loss of mode door function.	No mode change at all.	Check for damaged mode switch or potentiometer and associated wiring.		
	Blower turns on and off rapidly.	Battery voltage is at least 12V. Battery voltage is less than 12V.	Ensure all system grounds and power connections are clean and tight. Charge battery.	System shuts off blower at 10V. Poor connections or weak battery can cause shutdown at up to 11V.
7. Erratic functions of blower, mode, temp, etc.		Check for damaged switch or pot and associated wiring.	Repair or replace.	

Advanced Diagnostics and Troubleshooting Guide

If after referencing the Troubleshooting Guide, the issue is not resolved, move to The Advanced Diagnostics and Troubleshooting Guide that covers the following:

- ECU Diagnostics Codes
- 1. ECU Blink Sequence
- 2. Firmware Version Number
- 3. ECU Model Number
- 4. ECU Start-Up Blink Sequence
- 5. Diagnostic Codes
- Complete Advanced Troubleshooting Guidelines

Access the latest version of the Advanced Diagnostics and Troubleshooting Guide by scanning the following QR code on your mobile device:



You can also access the guide by typing the following address into your web browser:

https://www.vintageair.com/instructions_pdf/905000.pdf



www.vintageair.com

Templates: Driver-Side Under Dash Louver Bezel & Defrost Duct Mounting

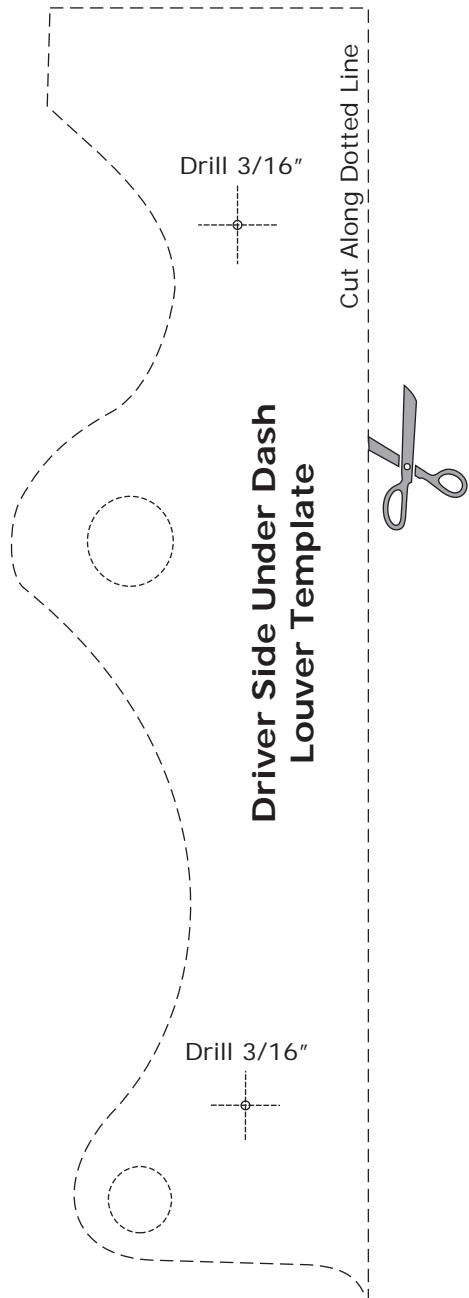

Driver Side Under Dash Louver Template

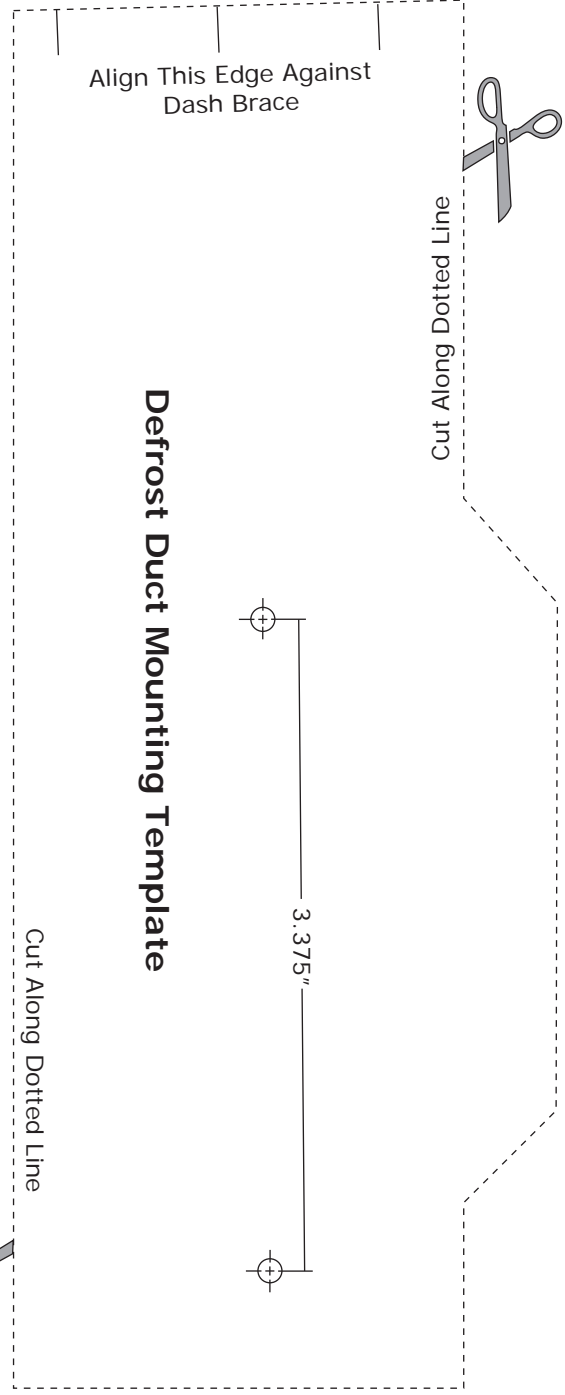

Defrost Duct Mounting Template

NOTE: Due to printing variances, measure the line below before using this template. If template is scaled properly, the line should measure 6 inches.





www.vintageair.com

Packing List: Evaporator Kit (561355)

No.	Qty.	Part No.	Description
1.	1	765200	Gen 5 Magnum Max Module with 404 ECU
2.	1	781355	Accessory Kit

Checked By: _____
Packed By: _____
Date: _____

1



Gen 5 Magnum Max
Module with 404 ECU
765200

2

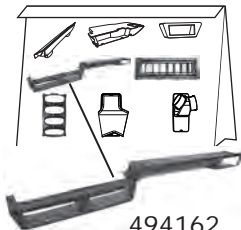
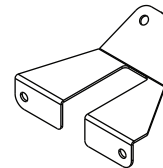
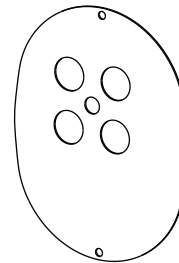
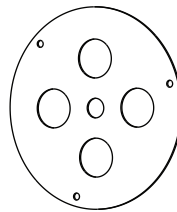
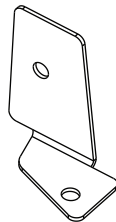
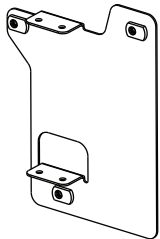
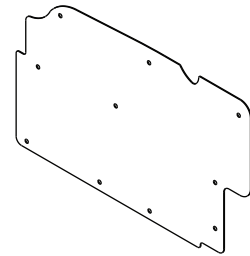

494162

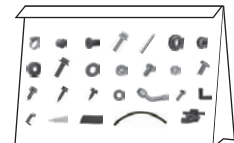
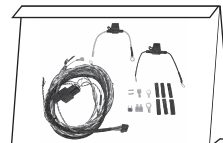
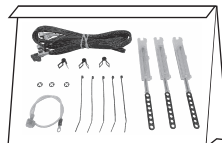

Accessory Kit
781355

**NOTE: Images may not depict actual parts and quantities.
Refer to packing list for actual parts and quantities.**