



1968 Chevrolet Nova

without **Factory Air**
Gen 5 Evaporator Kit
(561308)



18865 Goll St. San Antonio, TX 78266
Phone: 800-862-6658
Sales: sales@vintageair.com
Tech Support: tech@vintageair.com
www.vintageair.com



www.vintageair.com

Table of Contents

Cover.....	1
Table of Contents.....	2
Packing List/Parts Disclaimer.....	3
Information Page.....	4
Wiring Notice.....	5
Engine Compartment Disassembly.....	6
Passenger Compartment Disassembly, Condenser Assembly and Installation, Compressor and Brackets.....	7
Kick Panel Modification.....	8
Defrost Duct Installation, Firewall Modification.....	9
Fresh Air Cap & Kick Panel Cover Preparation, Heater and A/C Hose Installation.....	10
Heater and A/C Hose Installation (Cont.).....	11
Wiring Installation, Kick Panel Fresh Air Cap Installation.....	12
Relay Installation.....	13
Evaporator Module Preparation.....	14-15
Evaporator Installation.....	16
Evaporator Installation (Cont.), Drain Hose Installation.....	17
Firewall Cover Installation.....	18
Passenger Compartment Wiring.....	19
Lubricating O-rings, Properly Seated O-ring Land.....	20
A/C Hose Installation.....	21
Heater Control Valve Installation.....	22
Engine Compartment Wiring.....	23-24
Under Dash Louver Installation, Control Panel Installation.....	25
Final Steps: Installation Check.....	26
Final Steps: Completing the Install.....	27
Duct Hose Routing.....	28
Quality Crimp Guideline.....	29
Gen 5 Wiring Diagram.....	30
Gen 5 Wiring Connection Instruction.....	31
Operation of Controls.....	32
Troubleshooting Guide.....	33
Troubleshooting Guide (Cont.), Advanced Diagnostics and Troubleshooting Guide.....	34
Packing List.....	35



www.vintageair.com

Packing List: Evaporator Kit (561308)

No.	Qty.	Part No.	Description
1.	1	765200	Gen 5 Magnum Max Module with 404 ECU
2.	1	781308	Accessory Kit

**** Before beginning installation, open all packages and check contents of shipment. Please report any shortages directly to Vintage Air within 15 days. After 15 days, Vintage Air will not be responsible for missing or damaged items.**

1

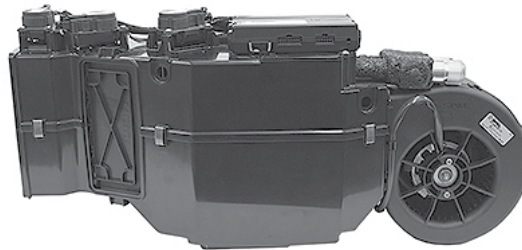

**Gen 5 Magnum Max
Module with 404 ECU
765200**

2

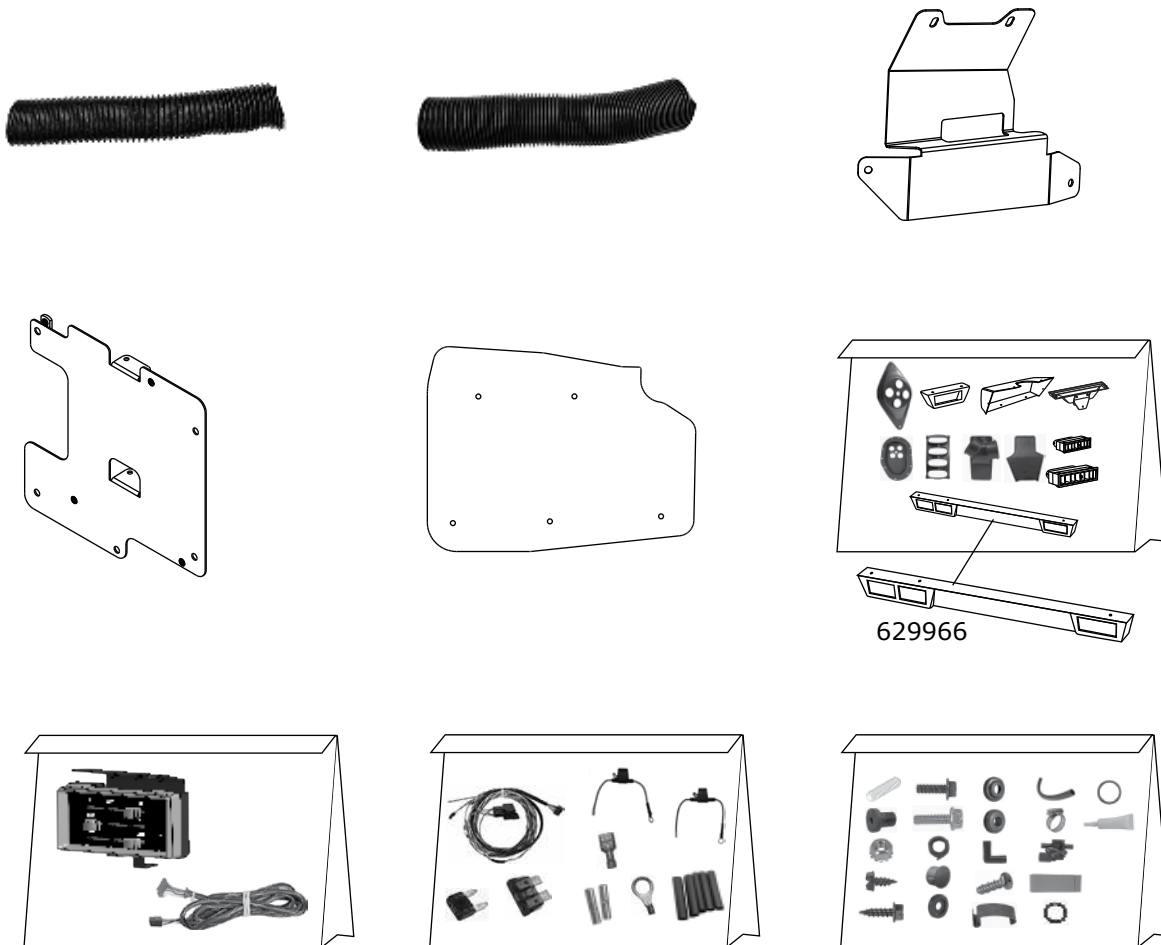

**Accessory Kit
781308**

NOTE: Images may not depict actual parts and quantities. Refer to packing list for actual parts and quantities.



www.vintageair.com

Important Notice—Please Read

For Maximum System Performance, Vintage Air Recommends the Following:

NOTE: Vintage Air systems are designed to operate with R134a refrigerant only. Use of any other refrigerant could damage your A/C system and/or vehicle, and possibly cause a fire, in addition to potentially voiding the warranties of the A/C system and its components.

Refrigerant Capacities:

Vintage Air System: 1.8 lbs. (28.8 oz.) or 816 grams of **R134a**, charged by weight with a quality charging station or scale. **NOTE: Use of the proper type and amount of refrigerant is critical to system operation and performance.**

Other Systems: Consult manufacturer's guidelines.

Lubricant Capacities:

New Vintage Air-Supplied Sanden Compressor: No additional oil needed (Compressor is shipped with proper oil charge).

All Other Compressors: Consult manufacturer (Some compressors are shipped dry and will need oil added).

Safety Switches

Your Vintage Air system is equipped with a binary pressure safety switch. A binary switch disengages the compressor clutch in cases of extreme low pressure conditions (refrigerant loss) or excessively high head pressure (406 PSI) to prevent compressor damage or hose rupture. A trinary switch combines Hi/Lo pressure protection with an electric fan operation signal at 254 PSI, and should be substituted for use with electric fans. Compressor safety switches are extremely important since an A/C system relies on refrigerant to circulate lubricant.

Service Info:

Protect Your Investment: Prior to assembly, it is critical that the compressor, evaporator, A/C hoses and fittings, hardlines, condenser and receiver/drier remain capped. Removing caps prior to assembly will allow moisture, insects and debris into the components, possibly leading to reduced performance and/or premature failure of your A/C system. This is especially important with the receiver/drier.

Additionally, when caps are removed for assembly, **BE CAREFUL!** Some components are shipped under pressure with dry nitrogen.

Evacuate the System for 35-45 Minutes: Ensure that system components (Drier, compressor, evaporator and condenser) are at a temperature of at least 85°F. On a cool day, the components can be heated with a heat gun **or** by running the engine with the heater on before evacuating. Leak check and charge to specifications.

Bolts Passing Through Cowl and/or Firewall:

To ensure a watertight seal between the passenger compartment and the vehicle exterior, for all bolts passing through the cowl and/or firewall, Vintage Air recommends coating the threads with silicone prior to installation.

Heater Hose (not included with this kit):

Heater hose may be purchased from Vintage Air (Part#31800-VUD) or your local parts retailer. Routing and required length will vary based on installer preference.



www.vintageair.com

Important Wiring Notice—Please Read

Some vehicles may have had some or all of their radio interference capacitors removed. There should be a capacitor found at each of the following locations:

- 1. On the positive terminal of the ignition coil.**
- 2. If there is a generator, on the armature terminal of the generator.**
- 3. If there is a generator, on the battery terminal of the voltage regulator.**

Most alternators have a capacitor installed internally to eliminate what is called “whining” as the engine is revved. If whining is heard in the radio, or just to be extra cautious, a radio interference capacitor can be added to the battery terminal of the alternator.

It is also important that the battery lead is in good shape and that the ground leads are not compromised. There should be a heavy ground from the battery to the engine block, and additional grounds to the body and chassis.

If these precautions are not observed, it is possible for voltage spikes to be present on the battery leads. These spikes come from ignition systems and charging systems, and from switching some of the vehicle’s other systems on and off. Modern computer-operated equipment can be sensitive to voltage spikes on the power leads, which can cause unexpected resets, strange behavior and/or permanent damage.

Vintage Air strives to harden our products against these types of electrical noise, but there is a point where a vehicle’s electrical system can be degraded so much that nothing can help.

Radio interference capacitors should be available at most auto and truck parts suppliers. They typically are cylindrical in shape, a little over an inch long and a little over a half-inch in diameter, and they have a single lead coming from one end of the cylinder with a terminal on the end of the wire, as well as a mounting clip which is screwed into a good ground on the vehicle. The specific value of the capacitance is not too significant in comparison to ignition capacitors that are matched with the coil to reduce pitting of the points.

- Care must be taken, when installing the compressor lead, not to short it to ground. The compressor lead must not be connected to a condenser fan or to any other auxiliary device. Shorting to ground or connecting to a condenser fan or any other auxiliary device may damage wiring or the compressor relay, and/or cause a malfunction.
- When installing ground leads on Gen 5 systems, the blower control ground and ECU ground must be connected directly to the negative battery post.
- For proper system operation, the heater control valve must be connected to the ECU.



www.vintageair.com

Engine Compartment Disassembly

NOTE: Before starting the installation, check the function of the vehicle (horn, lights, etc.) for proper operation, and study the instructions, illustrations, photos & diagrams.

Perform the following:

1. Disconnect the battery.
2. Remove the battery and battery tray (retain) (See Figure 1, below).
3. Drain the radiator. Remove the radiator (retain).
4. To remove the blower assembly (under hood) and the air distribution system (under dash), the factory manual indicates, remove the right inner fender panel.
5. Remove the OEM heater hoses (discard) (See Figure 1, below).
6. Remove the OEM heater wiring (discard) (See Figure 1, below).

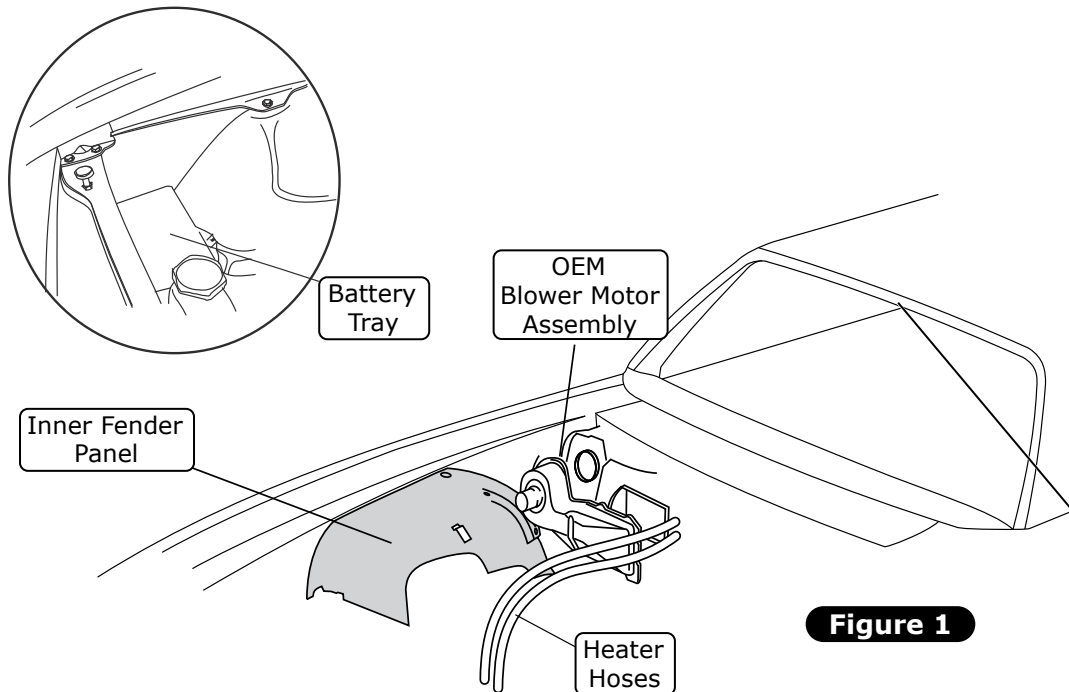

Figure 1



www.vintageair.com

Passenger Compartment Disassembly

NOTE: Removal of the instrument panel is required to install the evaporator. Vintage Air recommends that you utilize the factory service manual when you disassemble and reassemble the instrument panel.

1. Remove the glove box door (retain) (See Figure 1, below).
2. Remove the glove box (discard).
3. Remove the heater assembly (discard), retain screws (See Figure 1, below).
4. Remove the OEM defrost duct assembly (discard).
5. Disconnect all wire and cables from the instrument panel, speedometer, control panel and radio.
6. Remove the control panel assembly (retain).
7. Refer to the control panel conversion kit instructions for installation of controls.
8. Remove the passenger-side kick panel (retain).

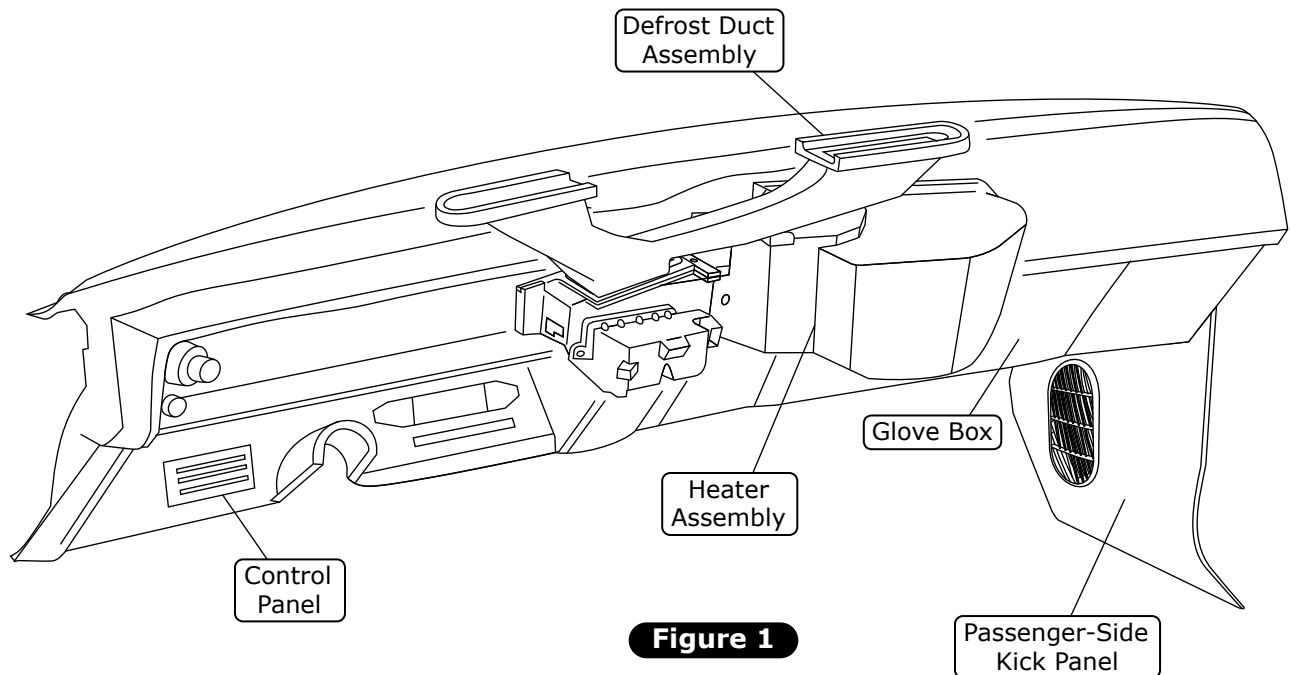

Figure 1

Condenser Assembly and Installation

1. Refer to separate instructions included with the condenser kit to install the condenser.
2. Binary switch installation (Refer to condenser instructions).

Compressor and Brackets

1. Refer to separate instructions included with the bracket kit to install the compressor bracket.



www.vintageair.com

Kick Panel Modification

1. Remove the kick panel.
2. Disconnect the pull cable assembly from the kick panel (discard).
3. Cut the fresh air door flush on the back side of the kick panel (discard) (See Figure 1, below).
4. Cut out the grille as shown in Figure 2, below.
5. Install a 1/2" plastic plug to fill the hole left from the removal of the pull cable assembly.

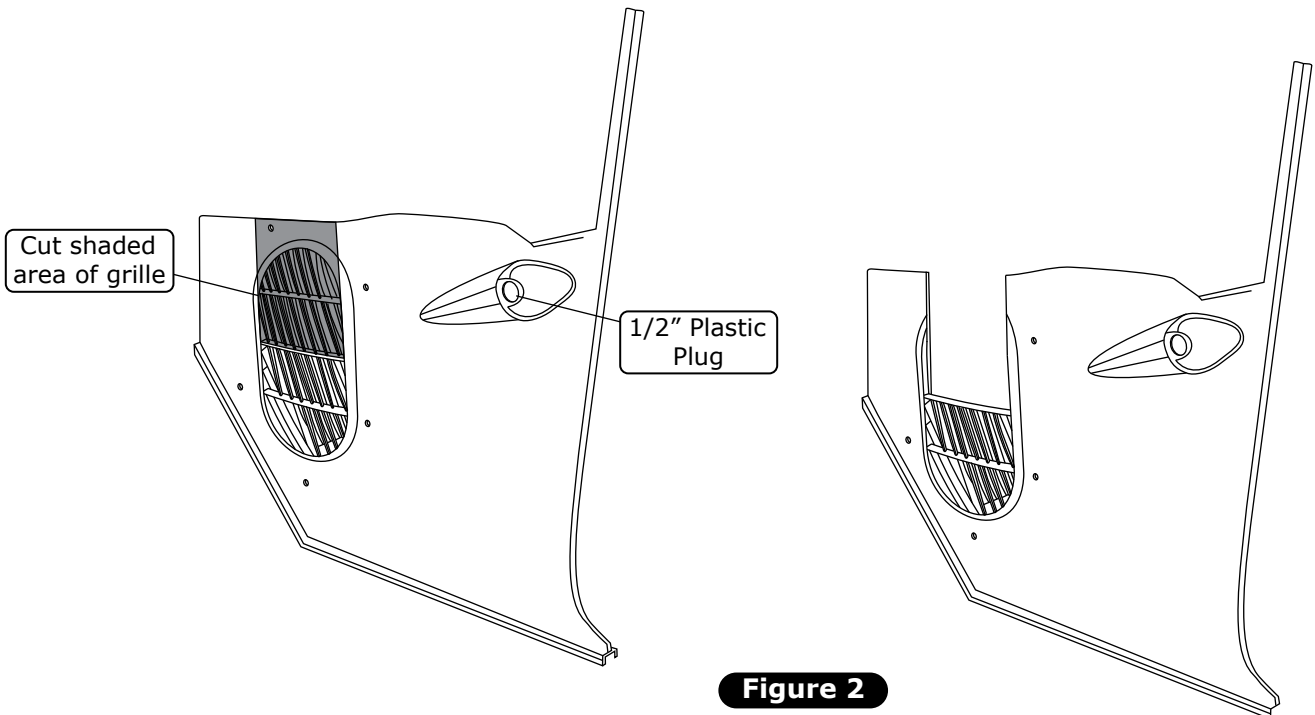
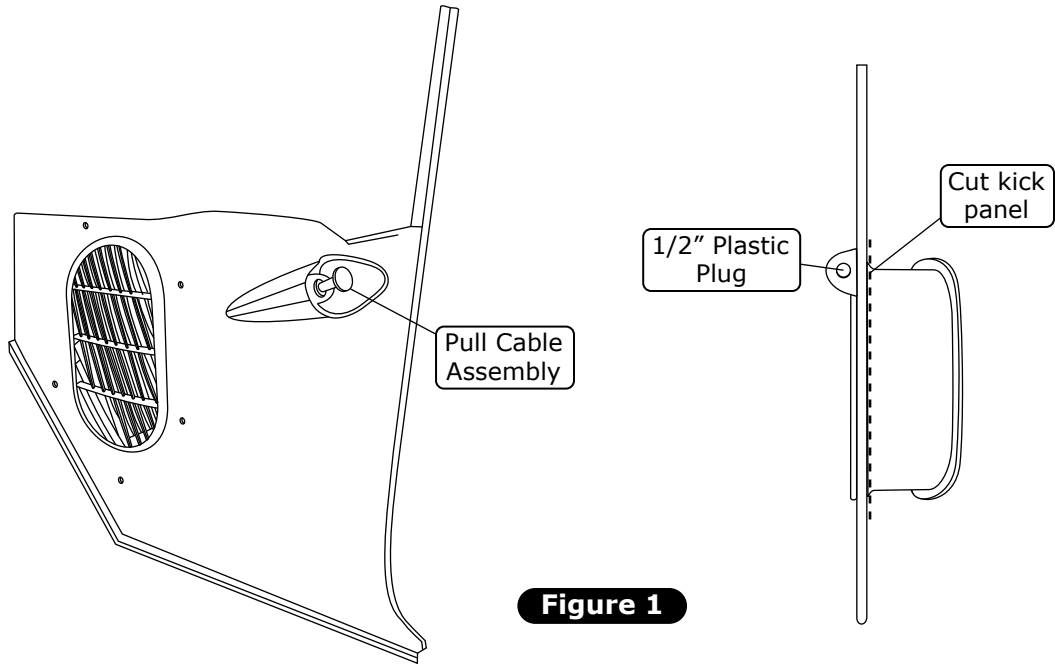



www.vintageair.com

Defrost Duct Installation

1. Install the defrost ducts under the dash as shown in Figure 1, below. Align the defrost ducts with defrost openings in the dash, hold in place. Use the bracket as a template and drill $7/64$ " hole. Secure using #10 x $1/2$ " sheet metal screw.

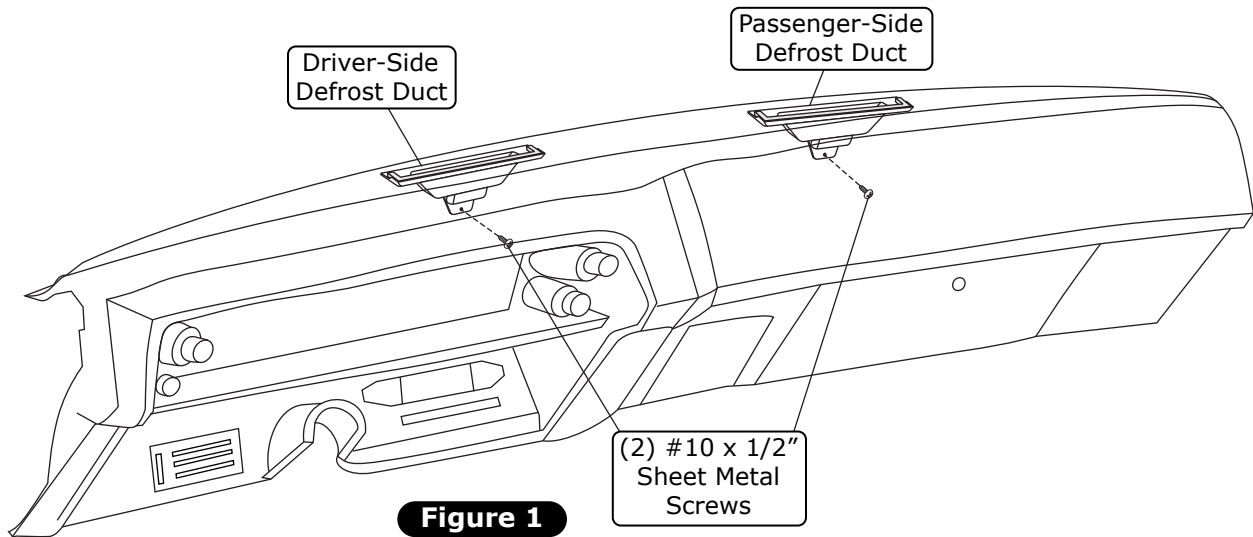

Firewall Modification

NOTE: Firewall modification is required for firewall cover and drain hose installation.

1. Flatten the edges of the firewall opening (See Photo 1, below).
2. Drill surrounding holes out to $9/32$ ".
3. Drill $5/8$ " hole in radius of footwell between the stock exhaust location and frame, approximately $2\ 1/2$ " from the mounting hole as shown in Figure 1, below.

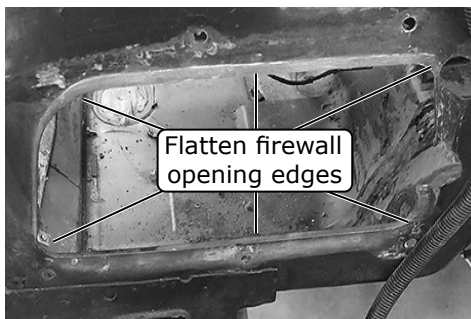

Engine Compartment Side

Photo 1

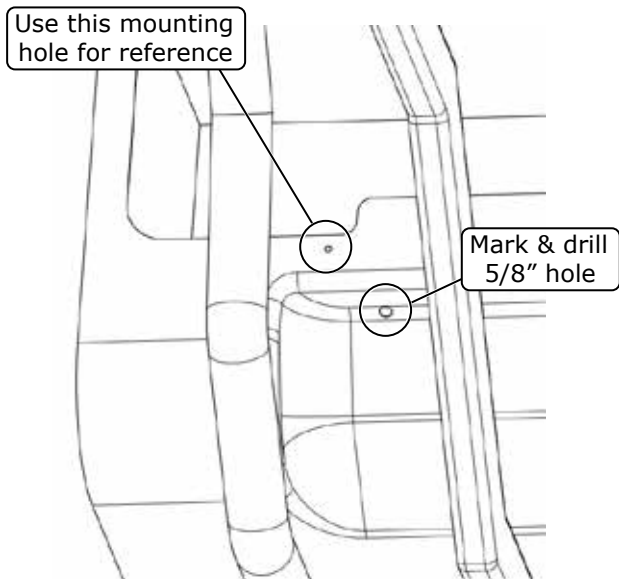

Figure 1



www.vintageair.com

Fresh Air Cap & Kick Panel Cover Preparation

1. Install (3) large, (1) 1 1/4" O.D. and (1) 7/8" O.D. grommets into the fresh air cap (See Photo 1, below).
2. Install (3) large, (1) 1 1/4" O.D. and (1) 7/8" O.D. grommets into the kick panel fresh air cap (See Photo 2, below).

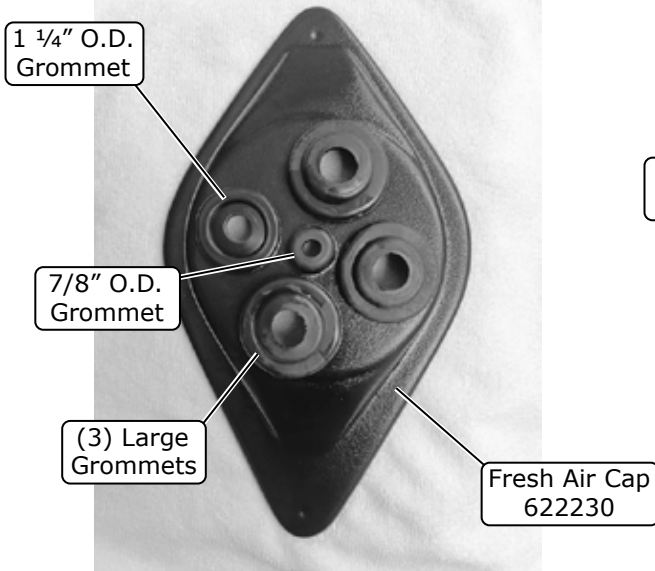

Photo 1

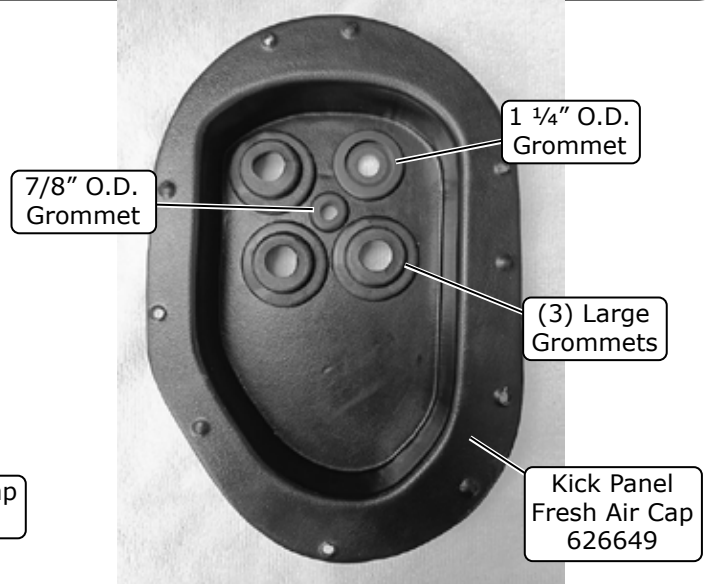

Photo 2

Heater and A/C Hose Installation

NOTE: Soapy water may be used to ease insertion of A/C and heater hoses through the grommets, but be sure the hoses are capped to prevent water from getting inside.

1. On the inside of the fresh air cap, the letter "T" indicates the top mounting hole for the firewall (See Photo 1, below).

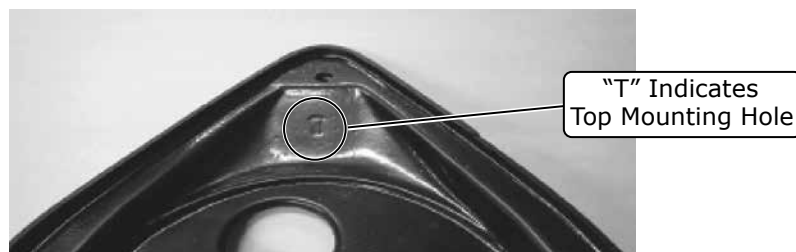

Photo 1



www.vintageair.com

Heater and A/C Hose Installation (Cont.)

2. Apply silicone to back side of fresh air cap and secure using (2) #14 x 3/4" washer head screws (See Photo 1, below).
3. Insert a length of heater hose through the bottom large grommet on the fresh air cap (See Photo 2, below).
4. Insert a length of heater hose through the right large grommet on the fresh air cap (See Photo 2, below).
5. Insert the 45° fitting on the #10 compressor/evaporator A/C hose through the top large grommet on the fresh air cap (See Photo 2, below). **NOTE: Temporarily remove the large grommet from the fresh air cap to ease insertion of the #10 hose fitting.**
6. Insert the 45° fitting on the #6 drier/evaporator A/C hose through the bottom-left 1 1/4" O.D. grommet on the fresh air cap (See Photo 2, below).
7. From the passenger compartment, insert the lower heater hose through the bottom-left grommet on the kick panel fresh air cap (See Photo 3, below).
8. Insert the upper heater hose through the top-left grommet on the kick panel fresh air cap (See Photo 3, below).
9. Insert the #10 compressor/evaporator A/C hose through the bottom-right grommet on the kick panel fresh air cap (See Photo 3, below). **NOTE: Temporarily remove the grommet from the kick panel fresh air cap for easier insertion.**
10. Insert the #6 drier/evaporator A/C hose through the top-right grommet on the kick panel fresh air cap (See Photo 3, below).



Photo 1

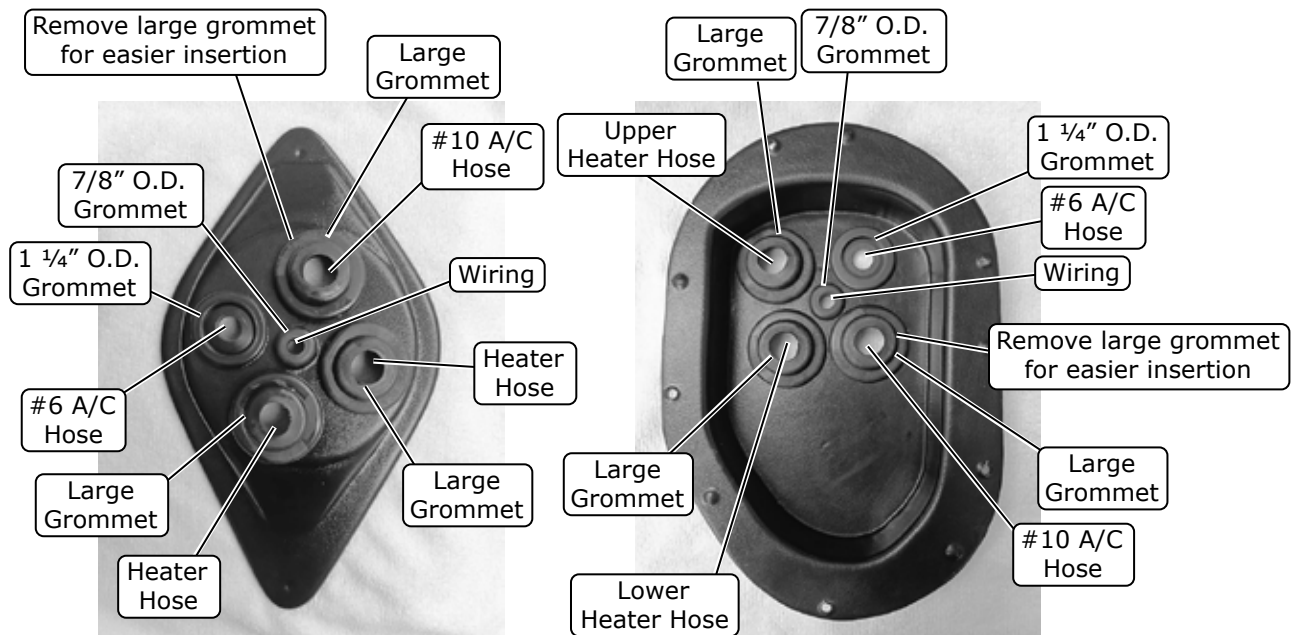

Photo 2

Photo 3



www.vintageair.com

Wiring Installation

NOTE: Some hoses and wiring orientations in images may differ due to year/model of vehicle. Reference Heater and A/C Hose Installation, Page 11, for layout.

1. From the passenger compartment, route the heater control valve connector and wiring (white, yellow and purple), and the red, white and blue wires from the main wiring harness through the 7/8" O.D. grommet on the kick panel fresh air cap and into the 7/8" O.D. grommet on the fresh air cap (See Photo 1, below). **NOTE: Leave approximately 5" of wiring between the relay and the kick panel fresh air cap. This is to allow enough wiring to secure the relay to the mounting position.**
2. Place the evaporator module on the passenger-side floorboard and route the orange and white wires through the 7/8" O.D. grommet on the kick panel fresh air cap, then through the 7/8" O.D. grommet on the fresh air cap.

Route heater control valve connector and wiring (white, yellow and purple), and red, white and blue wires from main wiring harness through 7/8" O.D. grommet on kick panel fresh air cap and into 7/8" O.D. grommet on fresh air cap

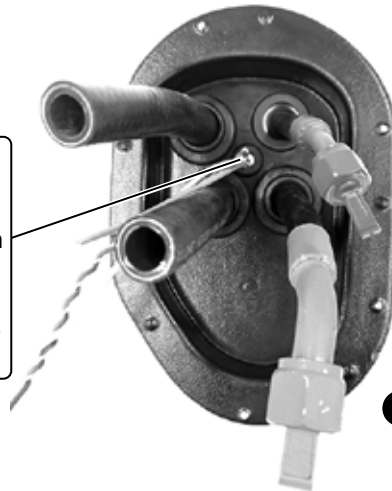

NOTE: Leave approximately 5" of wiring between relay and kick panel cover to allow enough wiring to secure relay to mounting position.

Photo 1

Kick Panel Fresh Air Cap Installation

NOTE: Ensure that the surface around the cap mounting area is clean and flat. Use silicone/or seam sealer or sealing rope to ensure no water from the cowl enters cabin.

1. Apply sealant around the mating surface of the kick panel fresh air cap (See Photo 1, below).
2. Install the kick panel fresh air cap into place, lining up the mounting holes on the cover with the OEM mounting holes on the kick panel opening.
3. Secure the kick panel using (5) #10 x 1/2" sheet metal screws through the pre-drilled holes as shown in Photo 1, below. **NOTE: After the cap is secured, make sure wiring has enough slack to form a "drip loop" in the cowl area. Apply sealant to the wires at the grommet.**

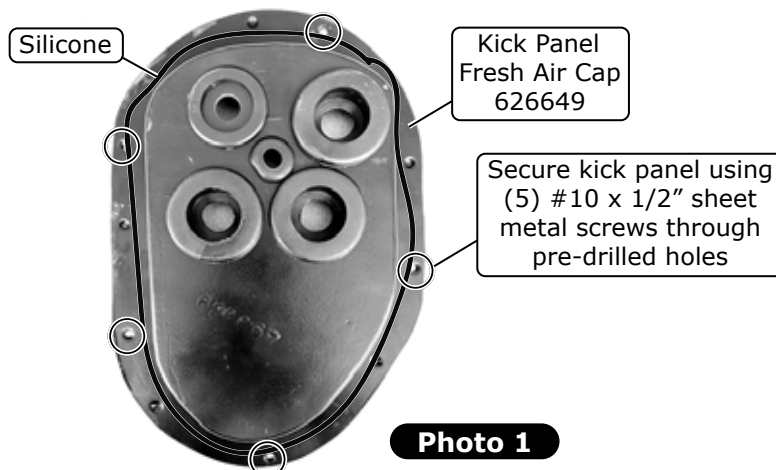

Photo 1



www.vintageair.com

Relay Installation

1. Select a suitable location for the relay and ground wire with ring terminal above the kick panel cover and trim.
2. Secure the relay to the kick panel using (2) #12 x 1/2" self-tapping screws as shown in Figure 1, below.

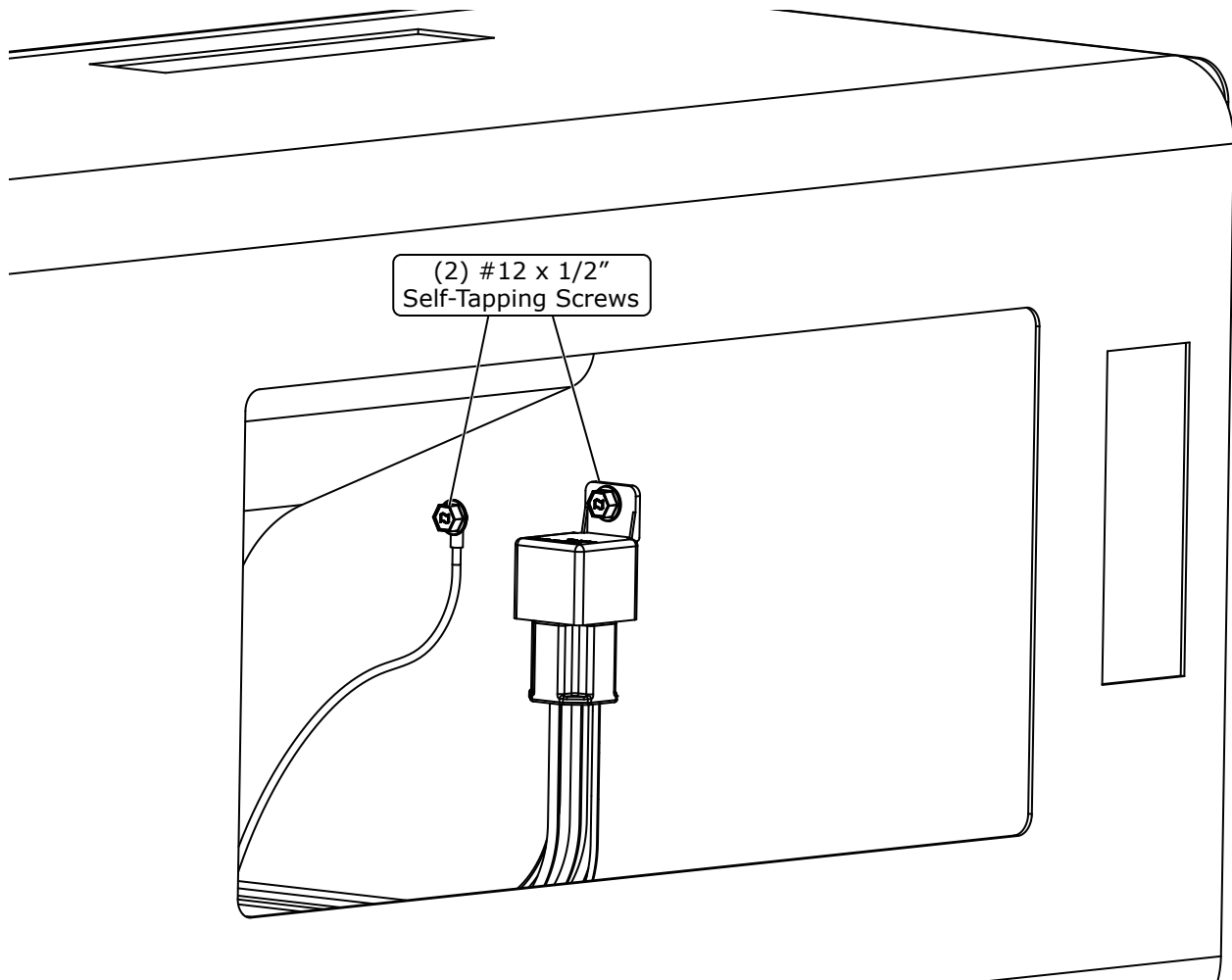

Figure 1



www.vintageair.com

Evaporator Module Preparation

Perform the following on a workbench:

1. Install (3) 1/2" plastic plugs into the back of the evaporator module (See Photos 1, 2, 3 and 4, below).
2. Using a properly lubricated #10 O-ring (See Lubricating O-rings, Page 20), install the upper heater hardline onto the evaporator module (See Photo 5, below). **NOTE: Install the hardline facing down.**
3. Using a properly lubricated #10 O-ring (See Lubricating O-rings, Page 20, install the lower heater hardline onto the evaporator module (See Photo 6, below). **NOTE: Install the hardline facing down.**
4. Install the evaporator firewall bracket using (4) #10 x 5/8" screws (See Photos 7, 8 and 9, below).

Install 1/2" plastic plug into back of evaporator module

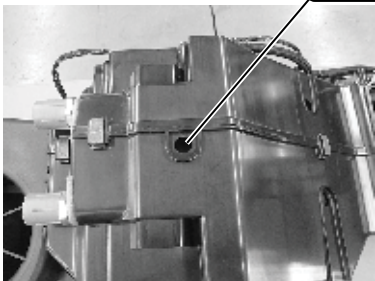

Photo 1

1/2" plastic plug

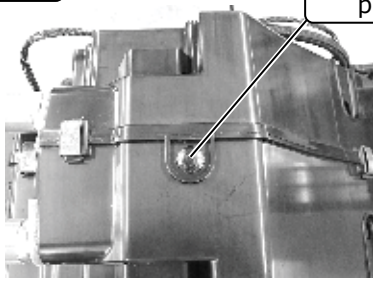

Photo 2

Install (2) 1/2" plastic plugs

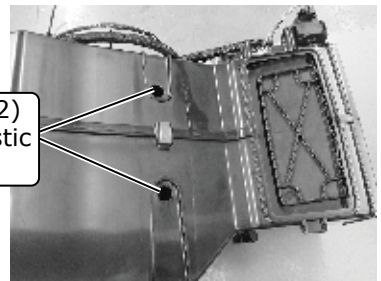
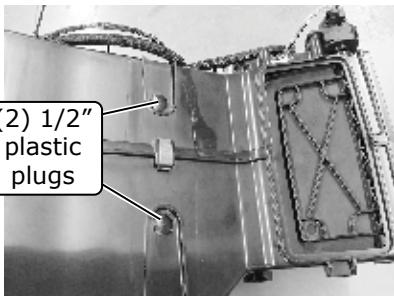

Photo 3

Install upper heater hardline onto evaporator module with properly lubricated #10 O-ring



(2) 1/2" plastic plugs

Photo 4

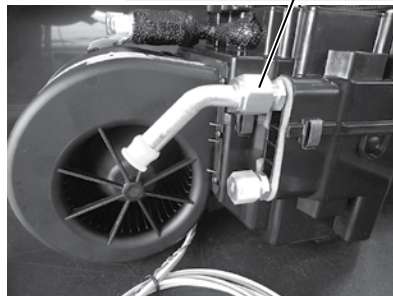
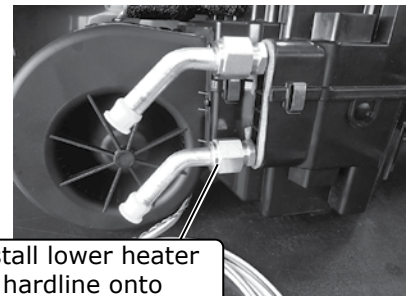

Photo 5



Install lower heater hardline onto evaporator module with properly lubricated #10 O-ring

Photo 6

Install evaporator firewall bracket (640717) onto evaporator module

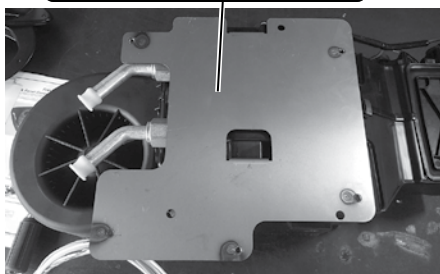
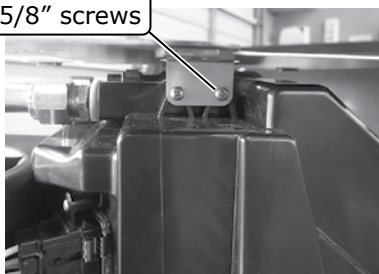

Photo 7

Secure bracket to module using (2) #10 x 5/8" screws



Bottom of Module View

Photo 8

Secure bracket to module using (2) #10 x 5/8" screws

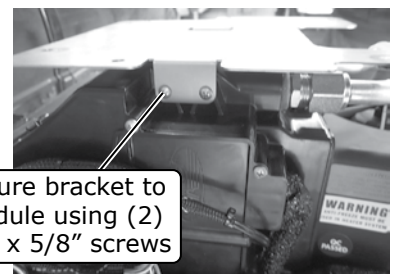

Top of Module View

Photo 9



www.vintageair.com

Evaporator Module Preparation (Cont.)

5. Install (2) 1/4-20 full-threaded studs into the (2) upper mounting holes on the evaporator firewall bracket (See Photo 10, below). **NOTE: Thread studs in a 1/4" of the way.**
6. Using (4) spring clips, install the dash plenum (See Photo 11, below).
7. Using (2) spring clips, install the floor plenum onto the back of the evaporator module (See Photo 12, below).
8. Using (2) spring clips, install the defrost plenum onto the front of the evaporator module (See Photo 13, below).

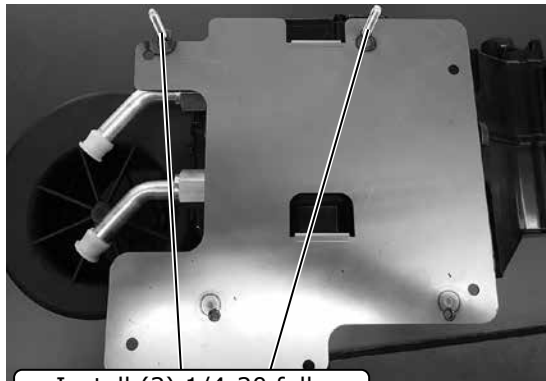

Install (2) 1/4-20 full-threaded studs into bracket a 1/4" of the way in

Photo 10

Secure dash plenum to module using (4) spring clips

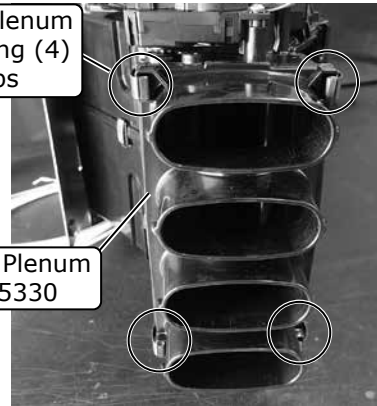

Dash Plenum
625330

Photo 11

Secure floor plenum to module using (2) spring clips

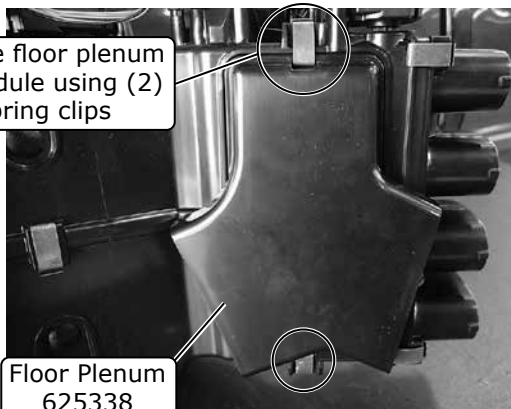

Floor Plenum
625338

Photo 12

Secure defrost plenum to module using (2) spring clips



Defrost Plenum
625331

Photo 13



www.vintageair.com

Evaporator Installation

NOTE: A 10" block of wood may be used to support the evaporator module while the following steps are completed. To ensure a watertight seal between the passenger compartment and the vehicle exterior, for all bolts passing through the firewall, Vintage Air recommends coating the threads with silicone prior to installation.

1. Install the upper heater hose and a hose clamp onto the upper heater hardline on the evaporator module (See Photo 1, below).
2. Install the lower heater hose and a hose clamp onto the lower heater hardline on the evaporator module (See Photo 2, below).
3. Roll the evaporator into it's mounting position. Insert the (2) 1/4-20 full-threaded studs into the upper OEM mounting holes on the firewall (See Photo 3, below).
4. Using a properly lubricated #6 O-ring (See Lubricating O-rings, Page 20), install the 45° fitting on the #6 drier/evaporator A/C hose onto the block-valve adapter on the evaporator module (See Photo 4, below).
5. Using a properly lubricated #10 O-ring (See Lubricating O-rings, Page 20), install the 45° fitting on the #10 compressor/evaporator A/C hose onto the #10 fitting on the block-valve adapter on the evaporator module (See Photo 5, below). **NOTE: After installing the #10 compressor/evaporator A/C hose, wrap all exposed metal with the supplied press tape (See Photo 6, below).**

Install upper heater hose onto upper heater hardline



Photo 1

Install lower heater hose onto lower heater hardline

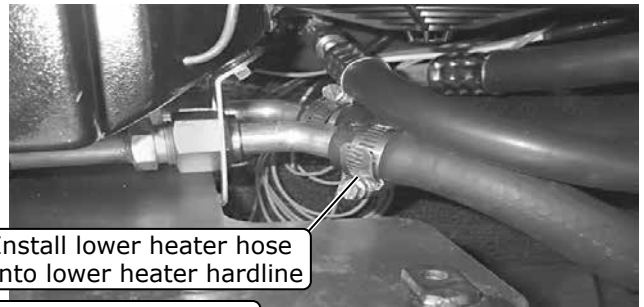

Photo 2

Install 45° fitting on #6 drier/evaporator A/C hose onto block-valve adapter

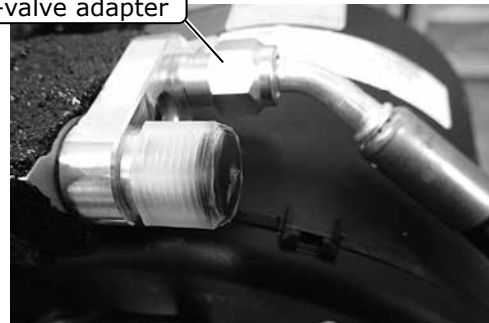
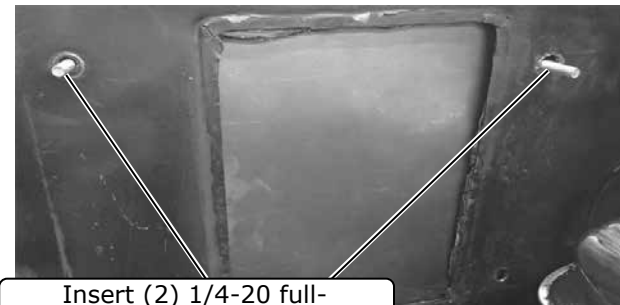

Photo 4



Insert (2) 1/4-20 full-threaded studs into upper OEM mounting holes on firewall

Photo 3

Install 45° fitting on #10 compressor/evaporator A/C hose onto block-valve adapter



Photo 5

Wrap all exposed metal with supplied press tape

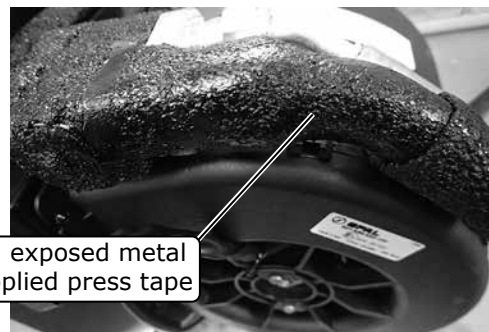

Photo 6



www.vintageair.com

Evaporator Installation (Cont.)

6. Install (2) 1/4-20 well nuts onto the evaporator module (See Photo 7, below).
7. Position the evaporator dash bracket under the glove box door mounting holes, then secure it onto the evaporator module using (2) 1/4-20 x 1" serrated flange bolts (See Figure 1, below).
8. Make sure that module is level front to back and side to side. Secure the evaporator dash bracket to the cowl using (2) #14 x 3/4" washer head screws (See Figure 1, below).

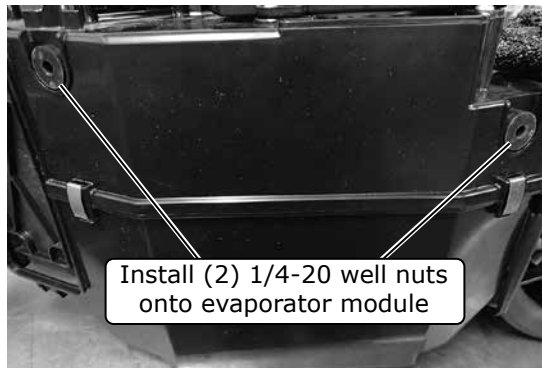

Photo 7

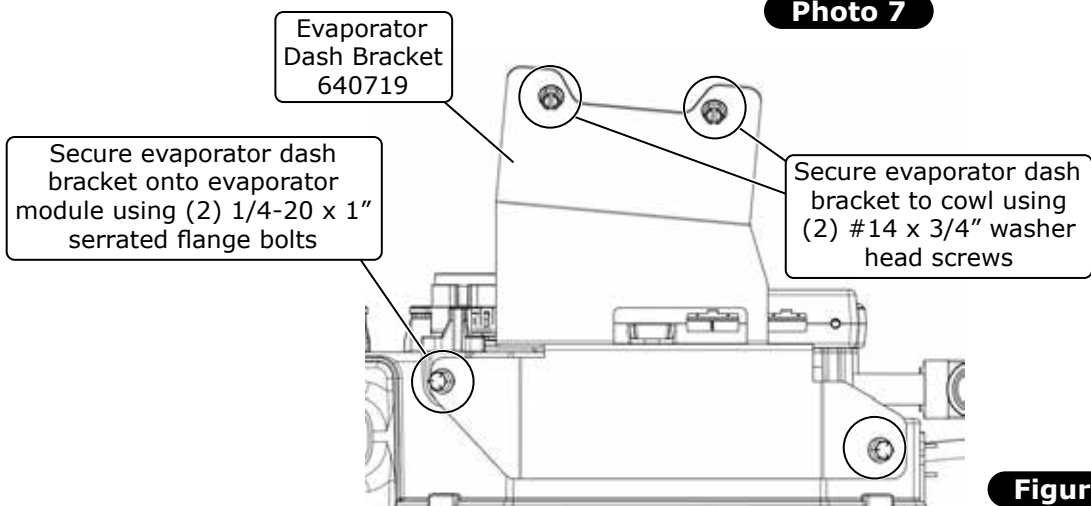

Figure 1

Drain Hose Installation

1. Install the drain hose through the previously drilled 5/8" hole in the firewall. Attach the drain hose onto the drain outlet on the bottom of the evaporator module (See Photo 1, below).



Photo 1



www.vintageair.com

Firewall Cover Installation

NOTE: To ensure a watertight seal between the passenger compartment and the exterior, for all bolts passing through the firewall, Vintage Air recommends coating the threads with silicone prior to installation.

1. Locate the bottom-left mounting hole on the firewall cover, and install a 1/4-20 x 3/4" black serrated flange bolt and a 1/4" pushnut retainer (See Photo 1, below).
2. Apply a bead of silicone around the mating surface of the firewall cover as shown in Photo 2, below.
3. Install the firewall cover onto the (2) 1/4-20 full-threaded studs, then secure it using (2) 1/4-20 nuts with star washers (See Photo 3, below).
4. Install (2) 1/4-20 x 3/4" black serrated flange bolts into the remaining open mounting holes on the firewall cover and into the evaporator firewall bracket (See Photo 4, below). **NOTE: Do not tighten at this time.**
5. Remove the (2) 1/4-20 nuts with star washers and (2) 1/4-20 full-threaded studs from the firewall cover, and replace them with (2) 1/4-20 x 3/4" black serrated flange bolts (See Photo 5, below).
6. Install (1) of the previously removed 1/4-20 nuts with star washers onto the bottom-right firewall cover bolt in the passenger compartment (See Photo 6, below).
7. Verify the evaporator module is level and square to the dash. **NOTE: To ensure proper drainage, it is very important that the evaporator is level, both left-right and fore-aft. Check for level on the flat portions of the case around the drain.**
8. Tighten all of the mounting bolts at this time. **NOTE: Tighten the bolts on the firewall first. Adjust the evaporator dash bracket as needed, then tighten the bolts on the evaporator module. Silicone or seam sealer may be applied around the outer edge of the firewall cover.**

Install a 1/4-20 x 3/4" black serrated flange bolt

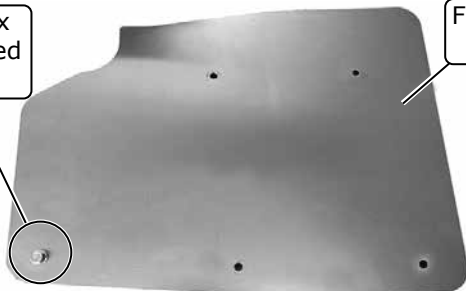

Engine Compartment Side View

Photo 1

Firewall Cover 640687

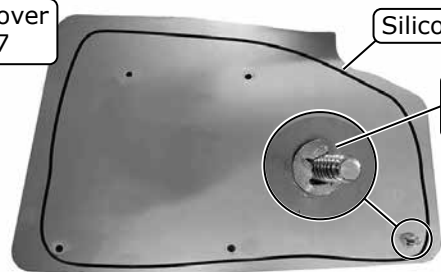

Passenger Compartment Side View

Photo 2

Silicone

1/4" Pushnut Bolt Retainer

Install firewall cover onto the (2) 1/4-20 full-threaded studs

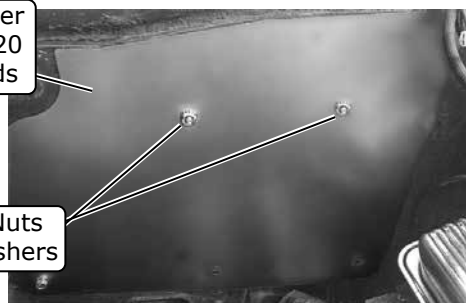

Engine Compartment View

Photo 3

(2) 1/4-20 Nuts with Star Washers



Photo 4

Install (2) 1/4-20 x 3/4" black serrated flange bolts

Remove (2) 1/4-20 nuts with star washers and (2) 1/4-20 full-threaded studs, then replace with (2) 1/4-20 x 3/4" black serrated flange bolts

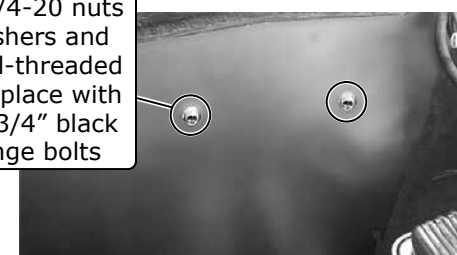

Engine Compartment View

Photo 5



Passenger Compartment View

Photo 6

Install a 1/4-20 nut with star washer onto bottom-right firewall cover bolt



www.vintageair.com

Passenger Compartment Wiring

1. Select a suitable ground location for the white ground wire eyelet from the heater control valve harness, and secure it using a #10 x 1/2" sheet metal screw.
2. Route the violet power wire to a switched 12v power source on the fuse panel (See Photo 1, below).
NOTE: This requires a male fuse extension (not supplied).
3. Connect the tan wire to the factory dash lights to enable control panel backlighting (if applicable).
4. Connect the BSC wiring to the main harness (See Photo 2, below).
5. Connect the main harness to the ECU (See Photo 3, below).

Attach Violet Wire to Switched Power Source

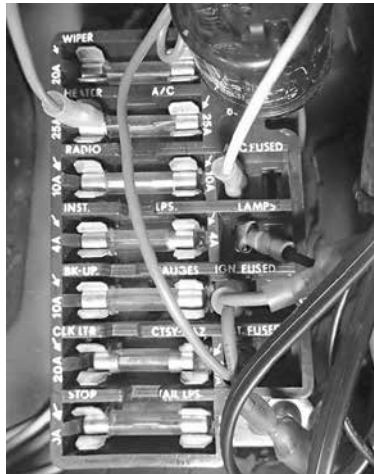
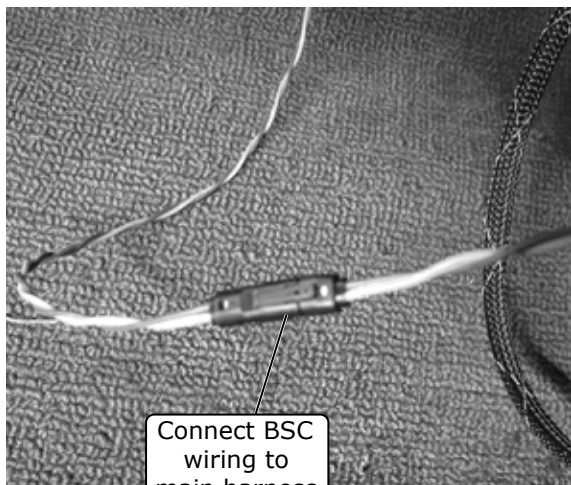
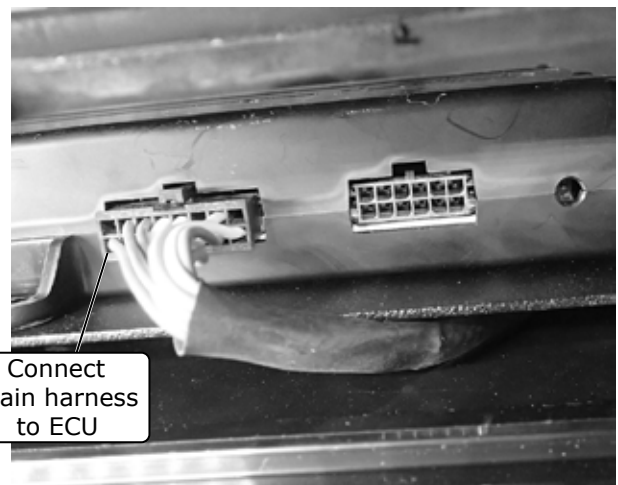

Photo 1



Connect BSC wiring to main harness

Photo 2



Connect main harness to ECU

Photo 3



www.vintageair.com

Lubricating O-rings

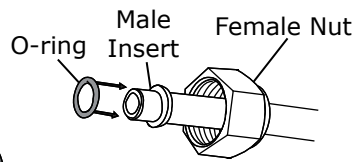
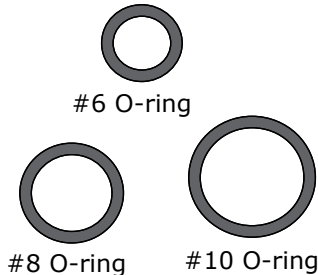

For a proper seal of fittings: Install supplied O-rings as shown and lubricate with refrigerant oil.

Refrigerant Oil for O-rings

O-ring installs over male insert to swaged lip

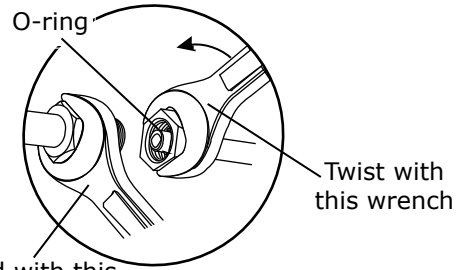

NOTE: Standard torque specifications:

#6: 11 to 13 ft-lb.

#8: 15 to 20 ft-lb.

#10: 21 to 27 ft-lb.

Properly Seated O-ring Land

When installing a hardline or A/C hose fitting onto the evaporator module, ensure the O-ring land is seated properly (See Photo 1, below). An improperly seated O-ring land (See Photo 2, below) can cause a leak. To properly install the fitting, slide the hardline or A/C hose nut back to expose the O-ring land and seat it onto the evaporator module fitting. Then, slide the hardline or A/C hose nut forward and thread it onto the evaporator module fitting, ensuring the O-ring land does not move or lift.

Properly Seated O-ring Land



Photo 1

Improperly Seated O-ring Land



Photo 2

NOTE: Photos shown are for reference only. Fittings may vary depending on kit received.



www.vintageair.com

A/C Hose Installation

Standard Hose Kit:

1. Locate the #8 condenser/compressor A/C hose. Lubricate (2) #8 O-rings (See Lubricating O-rings, Page 20), and connect the #8 90° fitting with service port to the #8 discharge port on the compressor (See Photo 1, below). Then, route the 45° fitting to the #8 condenser/core hardline coming from the condenser (See Photo 2, below). Tighten each fitting connection (See Lubricating O-rings, Page 20).
2. Locate the #10 compressor/evaporator A/C hose. Lubricate a #10 O-ring (See Lubricating O-rings, Page 20), and connect the #10 90° fitting with service port to the #10 suction port on the compressor (See Photo 1, below). Tighten the fitting connection (See Lubricating O-rings, Page 20).
3. Locate the #6 drier/evaporator hose. Lubricate a #6 O-ring (See Lubricating O-rings, Page 20), and connect it to the #6 drier/fenderwell hardline coming from the condenser (See Photo 2, below). Tighten the fitting connection (See Lubricating O-rings, Page 20).

Modified Hose Kit:

1. Refer to separate instructions included with modified hose kit.

#10 Compressor/
Evaporator A/C Hose
090176

Compressor



#8 Compressor/
Evaporator A/C Hose
090175

Photo 1

#6 Drier/Evaporator A/C Hose
090174

#6 Drier/Fenderwell Hardline
090173

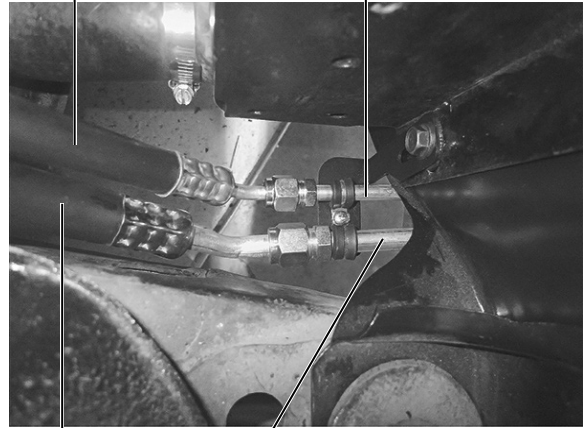

#8 Compressor/
Evaporator A/C Hose
090175

#8 Condenser/
Core Hardline
35367-VCG

Photo 2



www.vintageair.com

Heater Control Valve Installation

NOTE: Vintage Air Systems use 5/8" heater connections. On engines equipped with 3/4" hose nipples, these will need to be removed and replaced with 5/8" nipples (not supplied). For water pumps with a cast-in 3/4" heater outlet, a 3/4" x 5/8" reducer fitting (not supplied) or molded hose (Vintage Air Part # 099010) will need to be installed in the heater hose.

1. Route a piece of heater hose (not provided) from the lower heater core fitting to the water pump. Secure using hose clamps (See Photo 1, below).
2. Route a piece of heater hose (not provided) from the intake manifold to the heater control valve. Connect the heater hose from the upper heater core fitting to the heater control valve. Secure using hose clamps (See Figure 1 and Photo 2, below). **NOTE: Ensure proper flow direction through the heater control valve (the flow direction follows the molded arrow on the valve).**
3. Plug the heater control valve connector into the connector on the main wiring harness (See Photo 3, below).

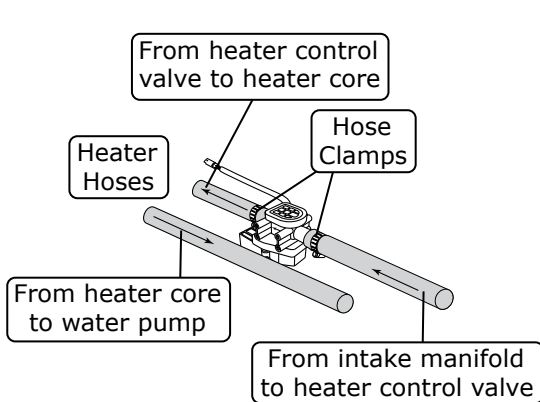

NOTE: Flow direction follows molded arrow on valve.

Figure 1

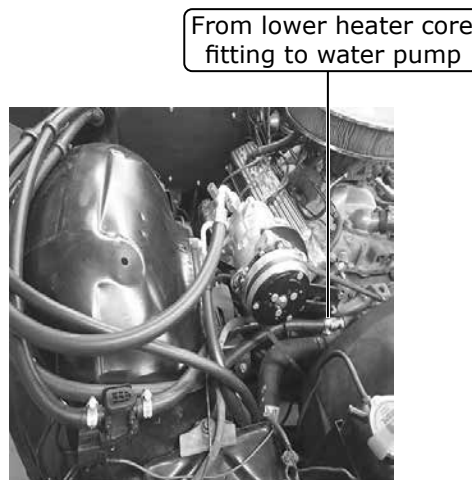

Photo 1

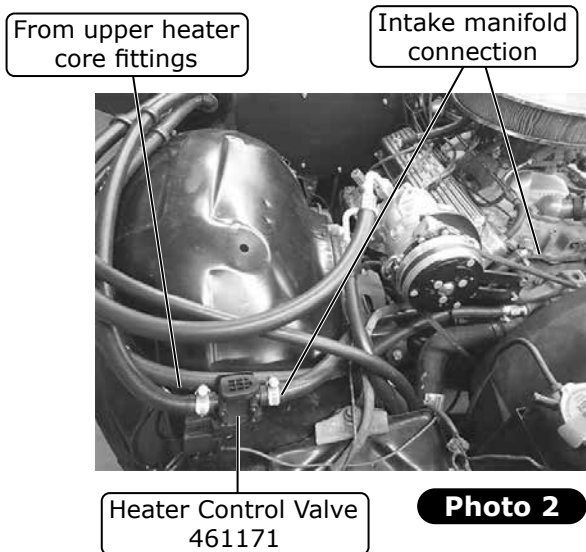

Photo 2

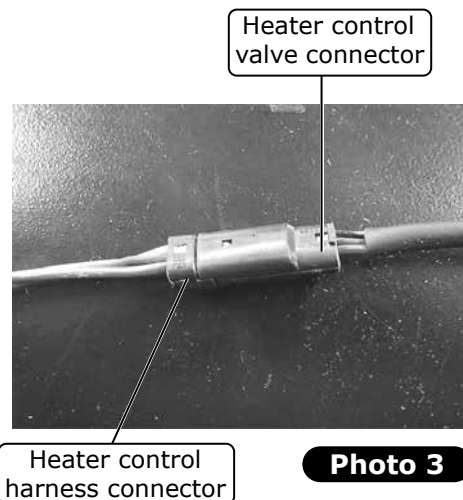

Photo 3



www.vintageair.com

Engine Compartment Wiring

1. Route the blue lead from the main wiring harness to the safety switch (See Photo 1, below).
2. Connect the compressor lead wire to the safety switch (See Photo 1, below).
3. Wrap the safety switch wiring with flexo sleeve, and secure it with the supplied tie wraps (See Photo 2, below).
4. Route power and ground wires toward the battery.
5. Install the supplied heat shrink over the 12 AWG orange fuse holder assembly wire, and crimp it to the 12 AWG orange wire from the main wiring harness (See Photo 3, below and Quality Crimp Guidelines, Page 29).
6. Install the supplied heat shrink over the 16 AWG black fuse holder assembly wire, and crimp it to the 16 AWG red wire from the main wiring harness (See Photo 4, below and Quality Crimp Guidelines, Page 29).

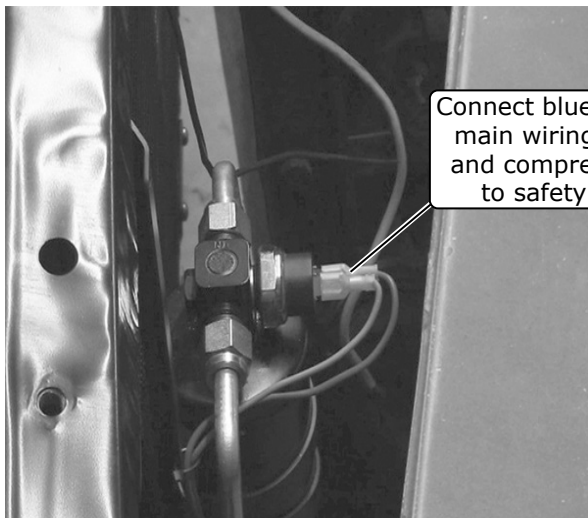

Connect blue lead from main wiring harness and compressor lead to safety switch

Photo 1

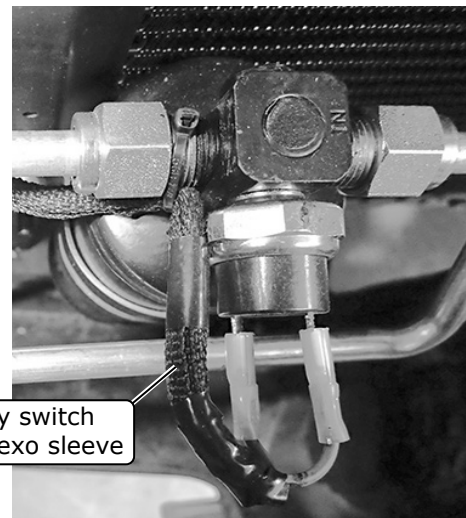

Wrap safety switch wiring with flexo sleeve

Photo 2

Install supplied heat shrink over 12 AWG orange fuse holder assembly and crimp to 12 AWG orange wire from main wiring harness



Photo 3

Install supplied heat shrink over 16 AWG black fuse holder assembly wire and crimp to 16 AWG red wire from main wiring harness

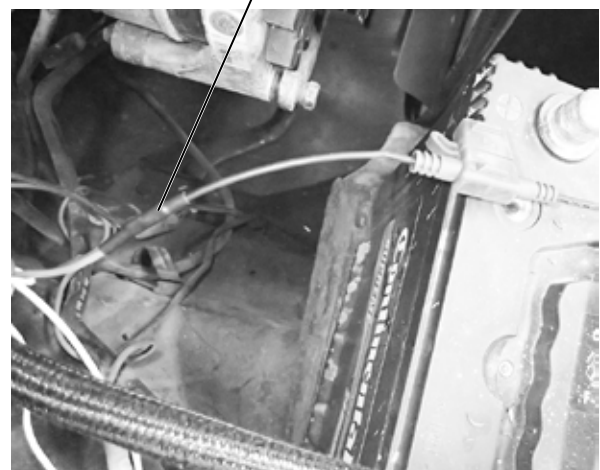

Photo 4



www.vintageair.com

Engine Compartment Wiring (Cont.)

7. Install fuses into the holders (See Photo 5, below).
 8. Install the supplied heat shrink over the white ground wires, then crimp on the supplied eyelets (See Photos 6 and 7, below and Quality Crimp Guidelines, Page 29)
 9. Connect the ground wiring eyelets to the negative battery terminal connector (See Photo 8, below).
 10. Connect the positive wiring eyelets to the positive battery terminal connector (See Photo 9, below).
- NOTE: Do not connect power until installation is completed.**

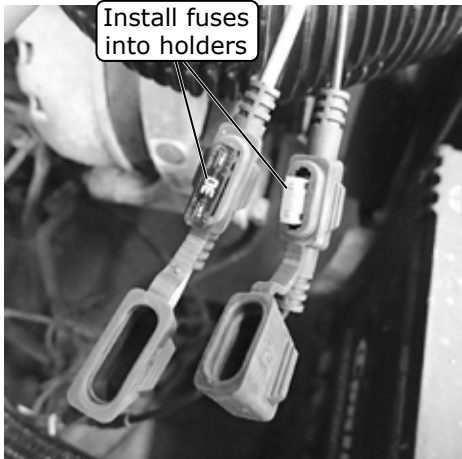

Photo 5

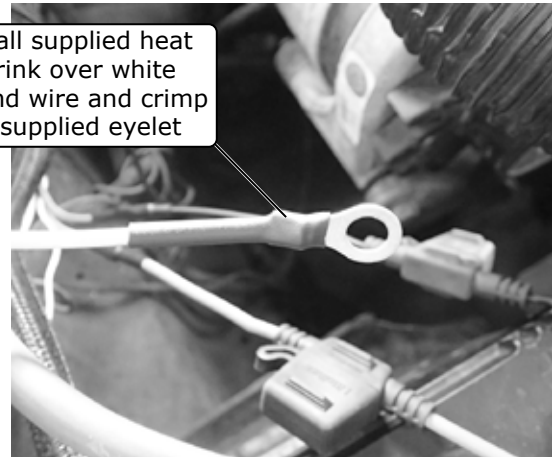

Photo 6

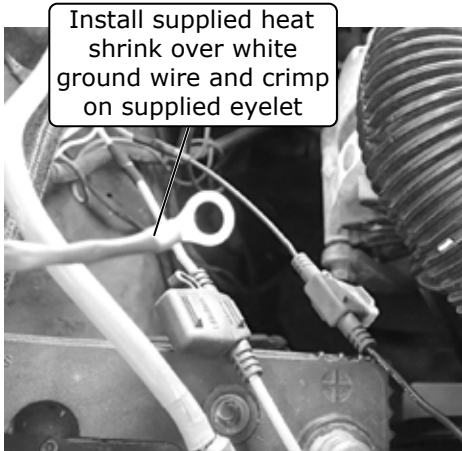

Photo 7

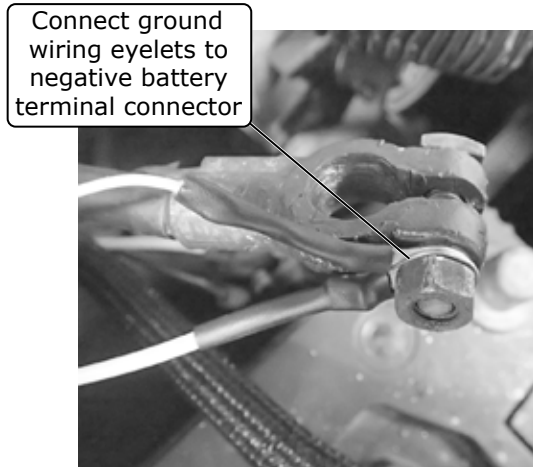

Photo 8



Photo 9

NOTE: Do not connect power until installation is completed.

Connect positive wiring eyelets to positive battery terminal connector



www.vintageair.com

Under Dash Louver Installation

1. Install the driver-side louver bezel using (2) #10 x 1/2" sheet metal screws as shown in Figure 1, below.
2. Install the louver in the driver-side louver bezel (See Figure 1, below).
3. Align and install the center/passenger-side louver bezel under the dash using (3) #10 x 1/2" sheet metal screws as shown in Figure 1a, below.
4. Install the louvers in the center/passenger-side louver bezel as shown in Figure 1 and Figure 1a, below.
5. Once the louver assembly is in place, route the duct hoses and attach them to the correct location on the evaporator as shown in Duct Hose Routing, Page 28.

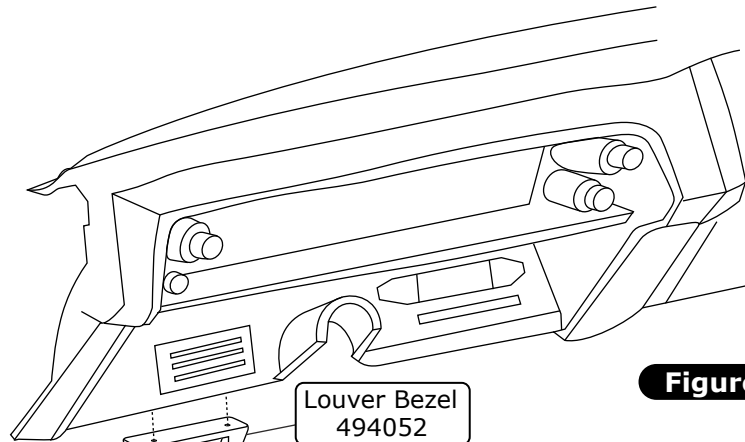

Figure 1

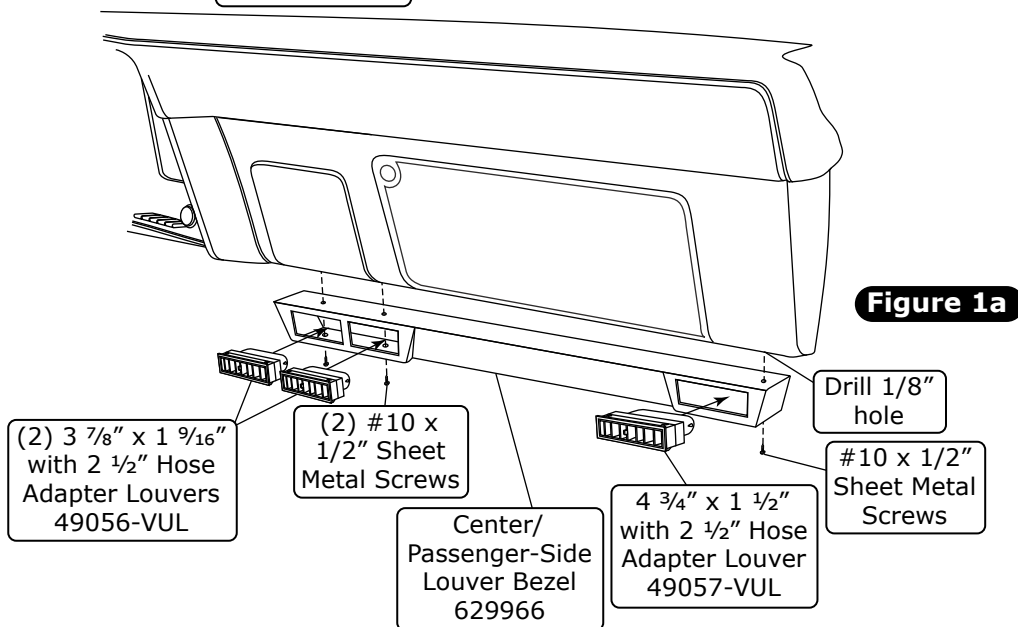

Figure 1a

Control Panel Installation

1. Refer to control panel instructions included with this kit.



www.vintageair.com

Final Steps: Installation Check

Installation Check	
ITEM TO CHECK	Procedure
<input type="checkbox"/>	<p>ECU</p> <p>If no blinking is observed after 1 minute of turning the ignition on, go to the next check.</p> <p>If repetitive blinking is observed, go to the Advanced Diagnostics Section to diagnose.</p>
<input type="checkbox"/>	<p>Blower speed control</p> <p>Set the blower speed control to OFF, <u>confirm that the blower is off</u>.</p> <p>Position the blower speed control to LOW then MEDIUM and then HIGH. <u>At each setting confirm that the blower speed increases</u>, do this by feeling for the amount of air coming from the unit and hearing the blower speed increase.</p>
<input type="checkbox"/>	<p>Mode control</p> <p>Set the MODE control to the DASH position. <u>Confirm that air is being blown at the dash vents</u>.</p> <p>Set the MODE control to the FLOOR position. <u>Confirm that air is being blown at the floor vents</u>.</p> <p>Set the MODE control to the DEFROST position. <u>Confirm that all air is being blown from the defrost vents</u></p> <p>If heater lines are installed:</p> <p>Set the MODE control to the DASH position. Set the TEMP control to the MAX HEAT position. <u>Confirm that HOT air is coming from the dash vents</u>.</p>
<input type="checkbox"/>	<p>Temperature control</p> <p>If system is charged:</p> <p>Set the TEMP control to the MAX COOL position. <u>Confirm that COLD air is coming from the dash vents</u>.</p> <p>Also <u>confirm that the compressor "clicks" on</u> when adjusting the TEMP control from the MAX HEAT position to the MAX COOL position.</p>
<input type="checkbox"/>	<p>AC Indicator (If applicable)</p> <p>While the MODE control is set to the DASH position, and the TEMP control is set to the MAX COOL/MIN HEAT position, <u>confirm that the blue AC Indicator light is on</u>.</p>
<input type="checkbox"/>	<p>Backlight (If applicable)</p> <p>If your control panel has backlight capabilities and has been wired, turn the dash lamp on and <u>confirm that the AC panel's legend is lit</u>.</p>
<input type="checkbox"/>	<p>Fittings</p> <p>Verify AC and Heater fittings are all tight.</p>



www.vintageair.com

Final Steps: Completing the Install

1. Reinstall all previously removed items.
2. Install the new glove box and glove box door using OEM screws (See Figure 1, below).
3. Fill radiator with at least a 50/50 mixture of approved antifreeze and distilled water. It is the owner's responsibility to keep the freeze protection at the proper level for the climate in which the vehicle is operated. Failure to follow antifreeze recommendations will cause heater core to corrode prematurely and possibly burst in A/C mode and/or freezing weather, voiding your warranty.
4. Double check all fittings, brackets and belts for tightness.
5. Vintage Air recommends that all A/C systems be serviced by a licensed automotive A/C technician.
6. Evacuate the system for a minimum of 45 minutes prior to charging, and perform a leak check prior to servicing.
7. Charge the system to the capacities stated on Page 4 of this instruction manual.
8. See Operation of Controls procedures on Page 32.

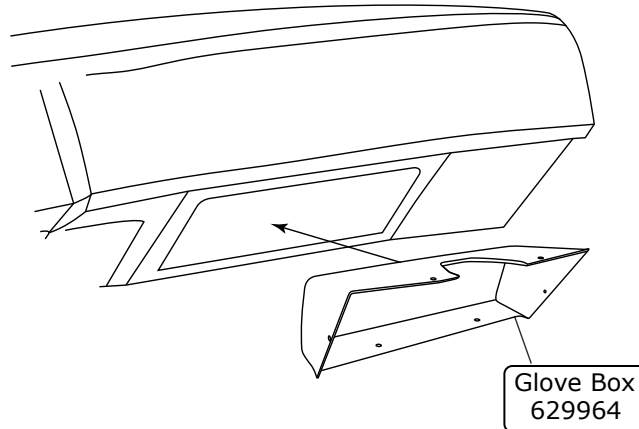



www.vintageair.com

Duct Hose Routing

NOTE: For the system to function optimally, the duct hoses must be routed as directly as possible, taking care to avoid kinks, sharp bends and unnecessary length. Vintage Air supplies duct hoses in continuous lengths that will need to be cut to size depending on application. Before cutting, familiarize yourself with the installation instructions and verify the routing will work with your application. For custom hose routing, additional hose may be needed and can be purchased from Vintage Air.

1. Stretch the duct hose until there is no slack, measure, mark and cut hose to size (See Photo 1, below).

Stretch, measure, mark and cut hose to size



Photo 1

Disclaimer: Before cutting duct hose to length, verify the routing will work for your application.

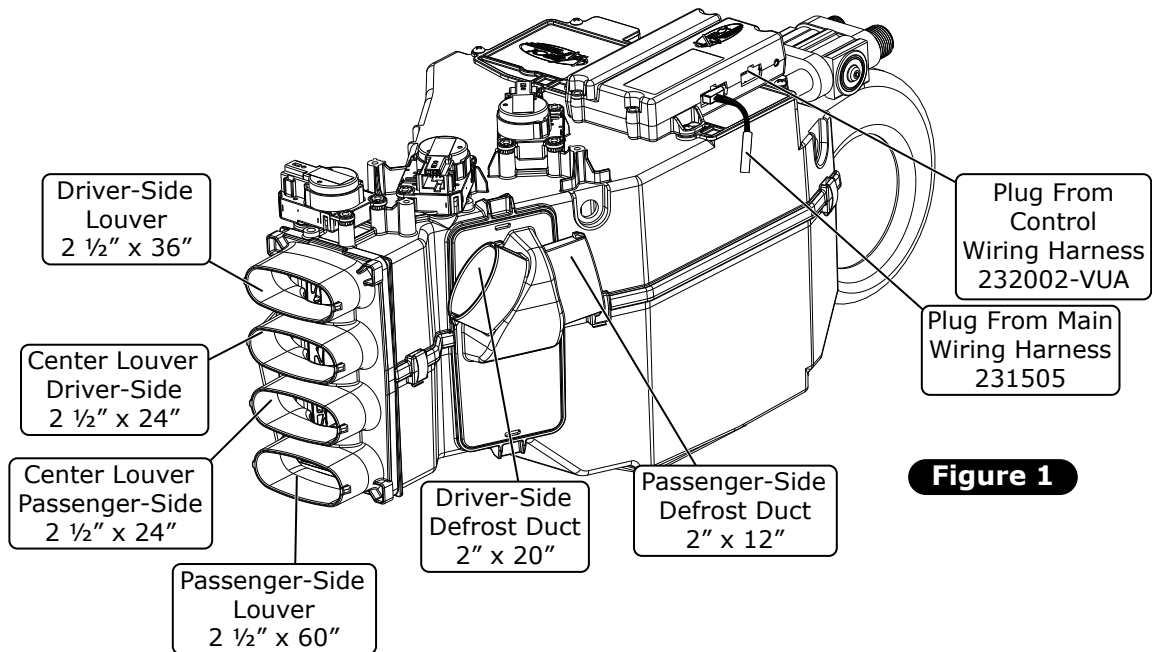

Figure 1



NOTE: ECU must be placed away from water and humidity, and also be accessible for servicing. If relocating, connectors must be positioned towards the bottom.

Position connectors towards bottom



www.vintageair.com

Quality Crimp Guideline

Acceptable strip length
(Some copper visible)

Crimped area is centered
on each side of splice

Bad strip length
(Too much copper visible)
Visible copper should be
just enough to ensure
clearance between splice
area and wire insulation

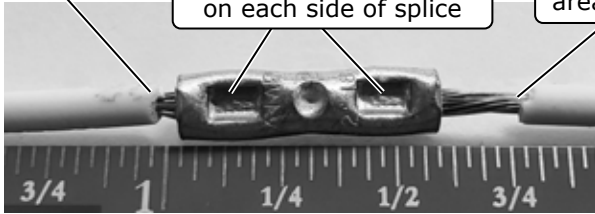

Photo 1

A good crimp requires
seam of butt splice to be
opposite of crimp die tooth

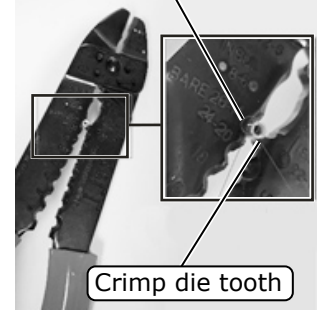
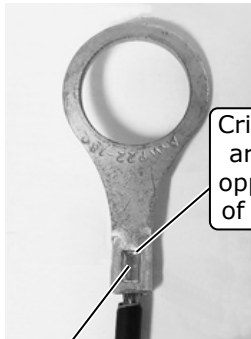

Photo 2

Good Ring Terminal Crimp Bad Ring Terminal Crimp



Crimped
area is
opposite
of seam

Photo 3

Crimp
area is
centered
on barrel



Crimp
area is not
centered on
barrel

Excessive
wire "brush"

Crimp area
is on seam
(Should be
opposite)

Photo 4

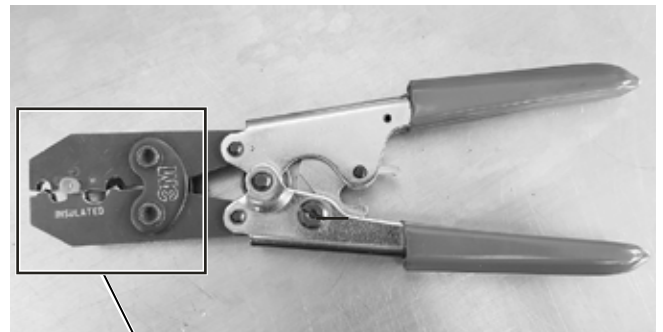

Photo 5

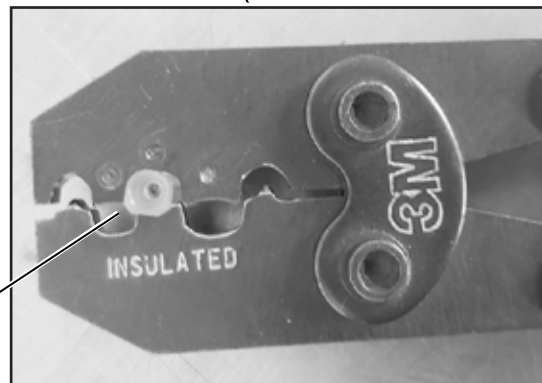

Photo 5a

Use a ratcheting crimp tool
for insulated barrel terminals
when crimping the provided
female insulated terminal.
Ensure terminal is inserted in
appropriate position before
crimping.



www.vintageair.com

Gen 5 Wiring Diagram

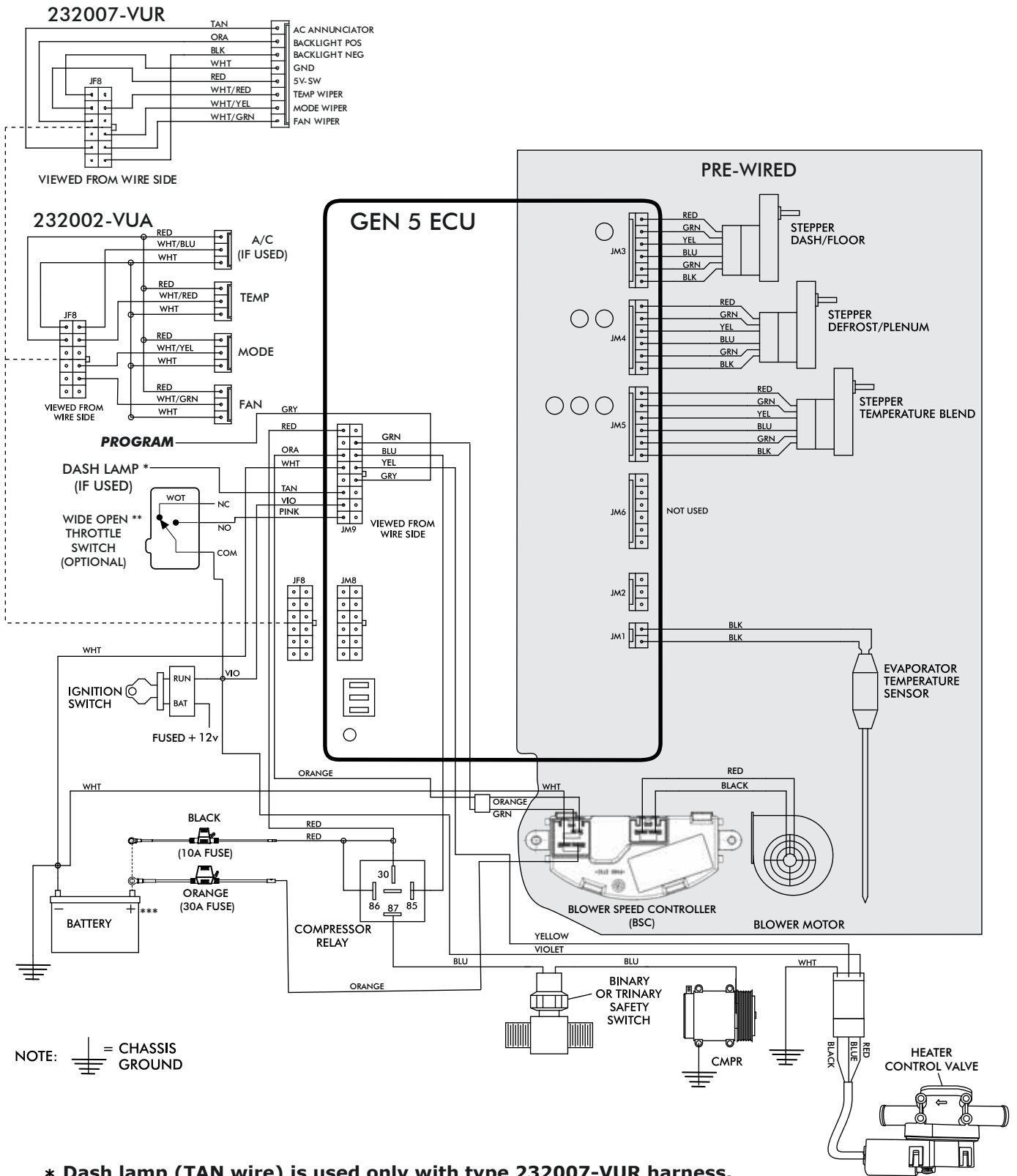

NOTE: = CHASSIS GROUND

- * Dash lamp (TAN wire) is used only with type 232007-VUR harness.
- ** Wide open throttle switch contacts close only at full throttle, which disables A/C compressor.
- *** Install fuse assemblies at or as near to the battery as possible.



www.vintageair.com

Gen 5 Wiring Instructions

WIRING HARNESS (231505) ↓

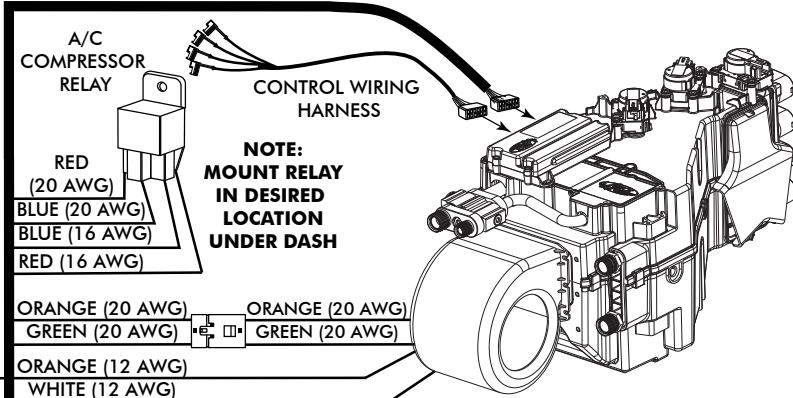

NOTE:
MOUNT RELAY
IN DESIRED
LOCATION
UNDER DASH

Ignition Switch:

Using provided butt splice (PN 226004), connect the 20 AWG violet wire to a 5A fused and switched 12V source such as Key On.

Wide Open Throttle Switch (Optional):

If a wide open throttle switch is required, connect the 20 AWG pink wire to a normally open switch that, when closed, connects a fused and switched 12V source to the pink wire. See Gen 5 wiring diagram for an example.

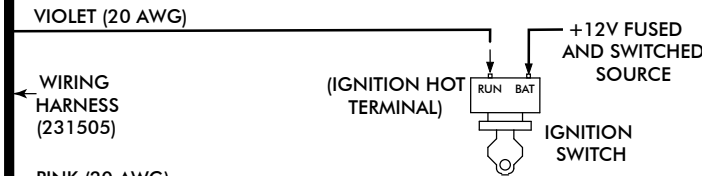

Dash Light (Optional):

If using a Vintage Air control panel with back light, connect the 20 AWG tan wire to the vehicle's dash back light 0-12V using provided butt splice (PN 226004).

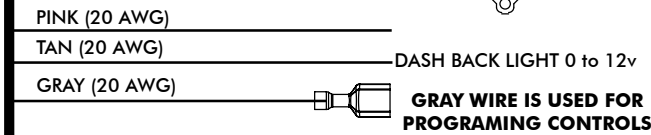

FIREWALL

FIREWALL

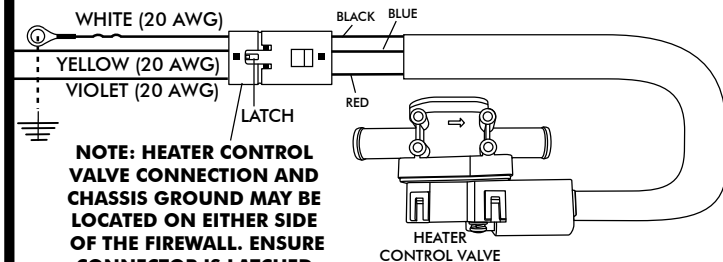

NOTE: HEATER CONTROL VALVE CONNECTION AND CHASSIS GROUND MAY BE LOCATED ON EITHER SIDE OF THE FIREWALL. ENSURE CONNECTOR IS LATCHED FIRMLY.

Heater Control Valve:

Connect the Violet/Yellow/White twisted branch with 3 position connector into the heater control valve connector. Ensure that the mating latch is fully seated.

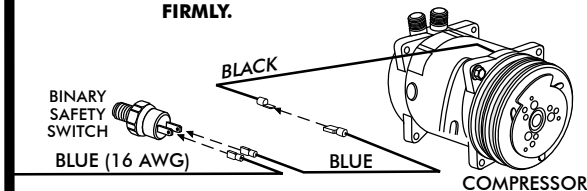

Binary/Trinary & Compressor:

Binary Switch: Terminate provided insulated female terminal (PN 23172-VUW) to the blue 16 AWG wire. Connect as shown.
Trinary Switch: Connect according to trinary switch wiring diagram.

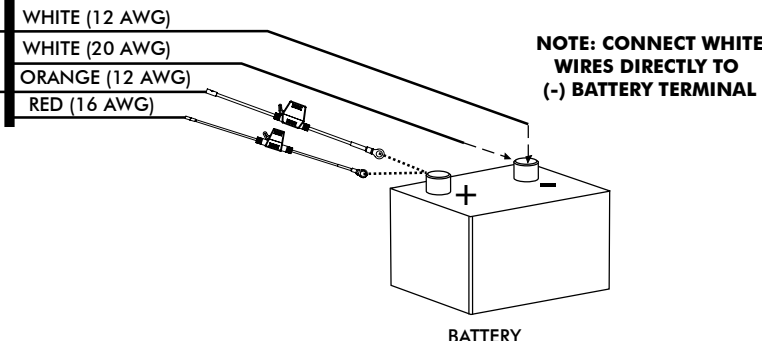

NOTE: CONNECT WHITE WIRES DIRECTLY TO (-) BATTERY TERMINAL

Battery Connections:

ECU Ground: Terminate provided ring terminal (PN 226110) to 20 AWG white wire from the 231505 wire assembly and install at battery.
ECU PWR: Terminate provided fuse assembly with black leads (PN 233012) to the 16 AWG red wire from the 231505 wire assembly. Install provided 10A Red Mini Fuse (PN 226118). Install at battery.
Blower Speed Controller (BSC) Ground: Terminate provided ring terminal (PN 226111) to 12 AWG white wire from the 232020 wire assembly and install at battery.
Blower Speed Controller (BSC) PWR: Terminate provided fuse assembly with orange leads (PN 233008) to the 12 AWG orange wire from the 232020 wire assembly. Install provided 30A Green ATO/ATC Fuse (PN 226125). Install at battery.



www.vintageair.com

Operation of Controls

On Gen IV or Gen 5 systems with three lever/knob controls, the temperature control toggles between heat and A/C operations. To activate A/C, move the temperature lever/knob all the way to cold and then back it off to the desired vent temperature. For heat operation, move the temperature lever/knob all the way to hot and then adjust to the desired vent temperature. The blower will momentarily change speed, each time you toggle in and out of heat and A/C operations, to indicate the change. **NOTE: For proper control panel function, refer to control panel instructions for calibration procedure.**

Blower Speed

This lever/knob controls blower speed, from OFF to HI.

Mode Control

This lever/knob controls the mode positions, from DASH to FLOOR to DEFROST, with a blend in between.

Temperature Control

This lever/knob controls the temperature, from HOT to COLD.

Temperature Control

Blower Speed



A/C Operation

Blower Speed

Adjust to desired speed.

Mode Control

Adjust to desired mode position (DASH position recommended).

Temperature Control

For A/C operation, adjust to coldest position to engage compressor (adjust between HOT and COLD to reach desired temperature).

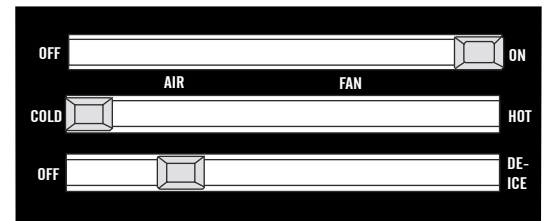

Heat Operation

Blower Speed

Adjust to desired speed.

Mode Control

Adjust to desired mode position (FLOOR position recommended).

Temperature Control

For maximum heating, adjust to hottest position (adjust between HOT and COLD to reach desired temperature).

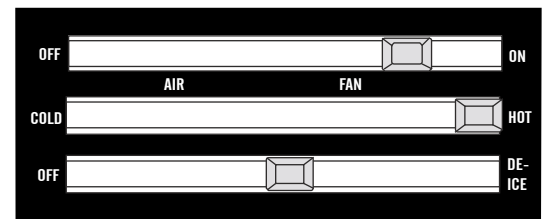

Defrost/De-fog Operation

Blower Speed

Adjust to desired speed.

Temperature Control

Adjust to desired temperature.

Mode Control

Adjust to DEFROST position for maximum defrost, or between FLOOR and DEFROST positions for a bi-level blend (Compressor is automatically engaged).

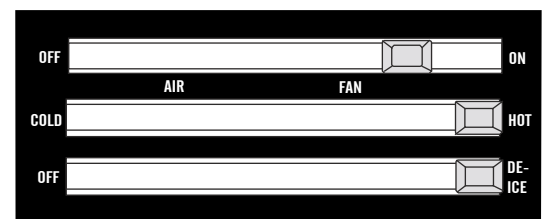



www.vintageair.com

Troubleshooting Guide

This printed troubleshooting guide is our basic guide that covers common installation problems. To see our advanced diagnostics and troubleshooting guide, please refer to the following page for instructions on how to download the complete guide.

WARNING: While troubleshooting the system, never probe connector terminals from the front mating side, only back probe.
WARNING: While troubleshooting the system, never use automotive check lights.

Symptom	Condition	Checks	Actions	Notes
1. Blower stays on high speed with ignition on.	No other functions work.	Check for damaged pins or wires in the control panel wire assembly and mating header at ECU.	If found damaged, replace wire assembly or ECU.	If fuse continues to blow, there is a serious problem in the wiring. Check all wiring and ensure the wire is not damaged and shorting out along its route.
	All other functions work.	Check for a bad ECU GND. Check for damaged pins or wires in the control panel wire assembly and mating header at ECU. Check if Blower power fuse is blown. Check for a bad ECU GND.	If found damaged, replace wire assembly or ECU. Replace fuse. Repair connection.	
2. Compressor will not turn on (All other functions work).	System is not charged.	System must be charged for compressor to engage.	Charge system.	Danger: Never bypass safety switch with engine running. Serious injury can result.
	System is charged.	Check for faulty A/C potentiometer or associated wiring (not applicable to 3-pot controls). Check for disconnected or faulty thermistor.	Check continuity to ground on white control head wire. Check for 5V on red control head wire. Check 2-pin connector at ECU housing.	To check for proper pot function, check voltage at white/red wire. Voltage should be between 0V and 5V, and will vary with pot lever position. Disconnected or faulty thermistor will cause compressor to be disabled.
	Compressor will not turn off (All other functions work).	Check for faulty A/C potentiometer or associated wiring. Check for faulty A/C relay.	Repair or replace pot/control wiring. Replace relay.	Red wire at A/C pot should have approximately 5V with ignition on. White wire will have continuity to chassis ground. White/Red wire should vary between 0V and 5V when lever is moved up or down.



www.vintageair.com

Troubleshooting Guide (Cont.)

Symptom	Condition	Checks	Actions	Notes
4. System will not turn on, or runs intermittently.	Works when engine is not running; shuts off when engine is started	Noise interference from either ignition or alternator.	Install capacitors on ignition coil and alternator. Ensure good ground at all points. Relocate coil and associated wiring away from ECU and ECU wiring. Check for burned or loose plug wires.	Ignition noise (radiated or conducted) will cause the system to shut down due to high voltage spikes. If this is suspected, check with a quality oscilloscope. Spikes greater than 16V will shut down the ECU. Install a radio capacitor at the positive post of the ignition coil (see radio capacitor installation bulletin). A faulty alternator or worn out battery can also result in this condition.
	Will not turn on under any conditions.	Verify connections on power lead, ignition lead, and both white ground wires. Verify battery voltage is greater than 10 volts and less than 16 while engine is running.	Check for power at ECU, and confirm ignition is being applied to ECU properly. Verify proper meter function by checking the condition of a known good battery.	
5. Loss of mode door function.	No mode change at all.	Check for damaged mode switch or potentiometer and associated wiring.		
6. Blower turns on and off rapidly.	Battery voltage is at least 12V.	Check for at least 12V at circuit breaker.	Ensure all system grounds and power connections are clean and tight.	System shuts off blower at 10V. Poor connections or weak battery can cause shutdown at up to 11V.
	Battery voltage is less than 12V.	Check for faulty battery or alternator.	Charge battery.	
7. Erratic functions of blower, mode, temp, etc.		Check for damaged switch or pot and associated wiring.	Repair or replace.	

Advanced Diagnostics and Troubleshooting Guide

If after referencing the Troubleshooting Guide, the issue is not resolved, move to The Advanced Diagnostics and Troubleshooting Guide that covers the following:

- **ECU Diagnostics Codes**
 1. **ECU Blink Sequence**
 2. **Firmware Version Number**
 3. **ECU Model Number**
 4. **ECU Start-Up Blink Sequence**
 5. **Diagnostic Codes**
- **Complete Advanced Troubleshooting Guidelines**

Access the latest version of the Advanced Diagnostics and Troubleshooting Guide by scanning the following QR code on your mobile device:



You can also access the guide by typing the following address into your web browser:

https://www.vintageair.com/instructions_pdf/905000.pdf



www.vintageair.com

Packing List: Evaporator Kit (561308)

No.	Qty.	Part No.	Description
1.	1	765200	Gen 5 Magnum Max Module with 404 ECU
2.	1	781308	Accessory Kit

Checked By: _____
Packed By: _____
Date: _____

1

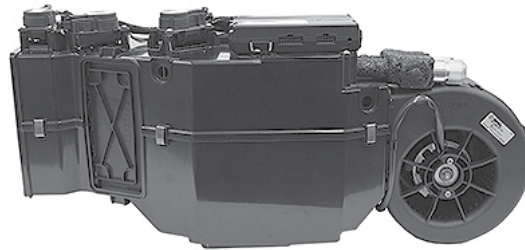

**Gen 5 Magnum Max
Module with 404 ECU
765200**

2

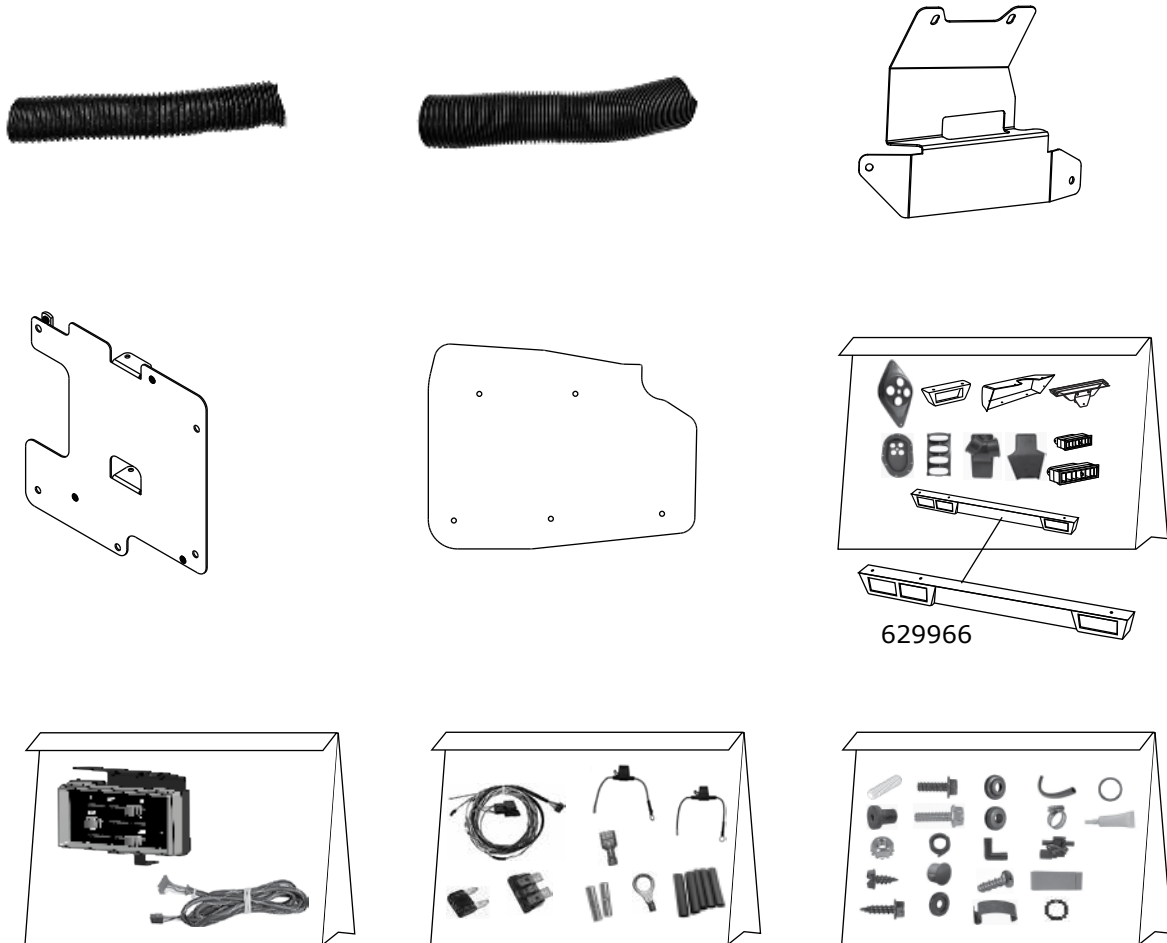

**Accessory Kit
781308**

**NOTE: Images may not depict actual parts and quantities.
Refer to packing list for actual parts and quantities.**