



1965-66 Chevrolet Impala

without Factory Air
Gen 5 Evaporator Kit
(561358)



18865 Goll St. San Antonio, TX 78266
Phone: 800-862-6658
Sales: sales@vintageair.com
Tech Support: tech@vintageair.com
www.vintageair.com



www.vintageair.com

Table of Contents

| | |
|---|-------|
| Cover..... | 1 |
| Table of Contents..... | 2 |
| Packing List/Parts Disclaimer..... | 3 |
| Information Page..... | 4 |
| Wiring Notice..... | 5 |
| Engine Compartment Disassembly..... | 6 |
| Condenser Assembly and Installation, Compressor and Brackets, Passenger Compartment..... | 7 |
| Passenger Compartment Disassembly (Cont.)..... | 8 |
| Passenger Compartment Disassembly (Final)..... | 9 |
| Kick Panel Modification, Firewall Cover Preparation, Firewall Modification..... | 10 |
| Firewall Cover Installation, Lubricating O-rings..... | 11 |
| Properly Seated O-ring Land, Evaporator Preparation..... | 12 |
| Evaporator Preparation (Cont.)..... | 13 |
| Fresh Air Cap & Kick Panel Preparation, Defrost Duct Installation..... | 14 |
| Wiring Installation..... | 15 |
| A/C & Heater Hoses and Kick Panel Cover Installation..... | 16 |
| A/C & Heater Hoses and Kick Panel Cover Installation (Cont.), Evaporator & A/C Hose Installation..... | 17 |
| Evaporator & A/C Hose Installation (Cont.)..... | 18 |
| Drain Hose Installation, ECU Wiring Harness Installation, Control Panel Installation..... | 19 |
| Under Dash Louver Preparation and Installation..... | 20 |
| Under Dash Louver Preparation and Installation (Cont.), Fresh Air Cap Installation..... | 21 |
| Heater Control Valve Installation..... | 22 |
| Inner Fender Installation, A/C Hose Installation..... | 23 |
| Wiring..... | 24 |
| Engine Compartment Wiring..... | 25-26 |
| Glove Box Installation..... | 27 |
| Final Steps: Installation Check..... | 28 |
| Final Steps: Completing the Install..... | 29 |
| Duct Hose Routing..... | 30 |
| Quality Crimp Guideline..... | 31 |
| Gen 5 Wiring Diagram..... | 32 |
| Gen 5 Wiring Connection Instruction..... | 33 |
| Operation of Controls..... | 34 |
| Troubleshooting Guide..... | 35 |
| Troubleshooting Guide (Cont.), Advanced Diagnostics and Troubleshooting Guide..... | 36 |
| Packing List..... | 37 |



www.vintageair.com

Packing List: Evaporator Kit (561358)

| No. | Qty. | Part No. | Description |
|-----|------|----------|--------------------------------------|
| 1. | 1 | 765225 | Gen 5 Magnum Max Module with 444 ECU |
| 2. | 1 | 781358 | Accessory Kit |

**** Before beginning installation, open all packages and check contents of shipment. Please report any shortages directly to Vintage Air within 15 days. After 15 days, Vintage Air will not be responsible for missing or damaged items.**

1

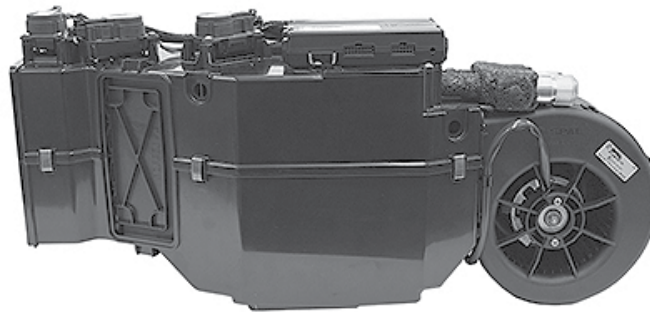

Gen 5 Magnum Max
Module with 444 ECU
765225

2

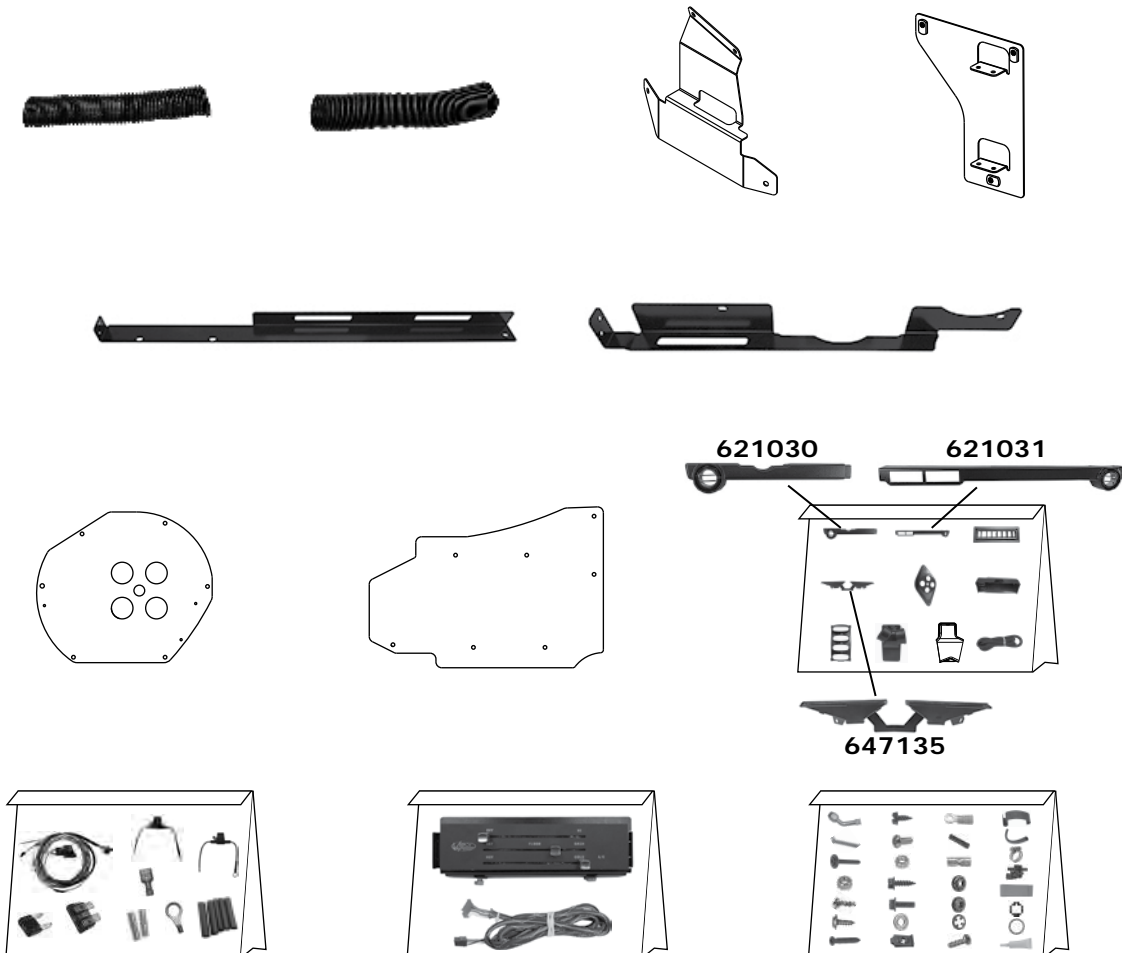

Accessory Kit
781358

NOTE: Images may not depict actual parts and quantities. Refer to packing list for actual parts and quantities.



www.vintageair.com

Important Notice—Please Read

For Maximum System Performance, Vintage Air Recommends the Following:

NOTE: Vintage Air systems are designed to operate with R134a refrigerant only. Use of any other refrigerant could damage your A/C system and/or vehicle, and possibly cause a fire, in addition to potentially voiding the warranties of the A/C system and its components.

Refrigerant Capacities:

Vintage Air System: 1.8 lbs. (28.8 oz.) or 816 grams of **R134a**, charged by weight with a quality charging station or scale. **NOTE: Use of the proper type and amount of refrigerant is critical to system operation and performance.**

Other Systems: Consult manufacturer's guidelines.

Lubricant Capacities:

New Vintage Air-Supplied Sanden Compressor: No additional oil needed (Compressor is shipped with proper oil charge).

All Other Compressors: Consult manufacturer (Some compressors are shipped dry and will need oil added).

Safety Switches

Your Vintage Air system is equipped with a binary pressure safety switch. A binary switch disengages the compressor clutch in cases of extreme low pressure conditions (refrigerant loss) or excessively high head pressure (406 PSI) to prevent compressor damage or hose rupture. A trinary switch combines Hi/Lo pressure protection with an electric fan operation signal at 254 PSI, and should be substituted for use with electric fans. Compressor safety switches are extremely important since an A/C system relies on refrigerant to circulate lubricant.

Service Info:

Protect Your Investment: Prior to assembly, it is critical that the compressor, evaporator, A/C hoses and fittings, hardlines, condenser and receiver/drier remain capped. Removing caps prior to assembly will allow moisture, insects and debris into the components, possibly leading to reduced performance and/or premature failure of your A/C system. This is especially important with the receiver/drier.

Additionally, when caps are removed for assembly, **BE CAREFUL!** Some components are shipped under pressure with dry nitrogen.

Evacuate the System for 35-45 Minutes: Ensure that system components (Drier, compressor, evaporator and condenser) are at a temperature of at least 85°F. On a cool day, the components can be heated with a heat gun **or** by running the engine with the heater on before evacuating. Leak check and charge to specifications.

Bolts Passing Through Cowl and/or Firewall:

To ensure a watertight seal between the passenger compartment and the vehicle exterior, for all bolts passing through the cowl and/or firewall, Vintage Air recommends coating the threads with silicone prior to installation.

Heater Hose (not included with this kit):

Heater hose may be purchased from Vintage Air (Part#31800-VUD) or your local parts retailer. Routing and required length will vary based on installer preference.



www.vintageair.com

Important Wiring Notice—Please Read

Some vehicles may have had some or all of their radio interference capacitors removed. There should be a capacitor found at each of the following locations:

- 1. On the positive terminal of the ignition coil.**
- 2. If there is a generator, on the armature terminal of the generator.**
- 3. If there is a generator, on the battery terminal of the voltage regulator.**

Most alternators have a capacitor installed internally to eliminate what is called “whining” as the engine is revved. If whining is heard in the radio, or just to be extra cautious, a radio interference capacitor can be added to the battery terminal of the alternator.

It is also important that the battery lead is in good shape and that the ground leads are not compromised. There should be a heavy ground from the battery to the engine block, and additional grounds to the body and chassis.

If these precautions are not observed, it is possible for voltage spikes to be present on the battery leads. These spikes come from ignition systems and charging systems, and from switching some of the vehicle’s other systems on and off. Modern computer-operated equipment can be sensitive to voltage spikes on the power leads, which can cause unexpected resets, strange behavior and/or permanent damage.

Vintage Air strives to harden our products against these types of electrical noise, but there is a point where a vehicle’s electrical system can be degraded so much that nothing can help.

Radio interference capacitors should be available at most auto and truck parts suppliers. They typically are cylindrical in shape, a little over an inch long and a little over a half-inch in diameter, and they have a single lead coming from one end of the cylinder with a terminal on the end of the wire, as well as a mounting clip which is screwed into a good ground on the vehicle. The specific value of the capacitance is not too significant in comparison to ignition capacitors that are matched with the coil to reduce pitting of the points.

- Care must be taken, when installing the compressor lead, not to short it to ground. The compressor lead must not be connected to a condenser fan or to any other auxiliary device. Shorting to ground or connecting to a condenser fan or any other auxiliary device may damage wiring or the compressor relay, and/or cause a malfunction.
- When installing ground leads on Gen 5 systems, the blower control ground and ECU ground must be connected directly to the negative battery post.
- For proper system operation, the heater control valve must be connected to the ECU.



www.vintageair.com

Engine Compartment Disassembly

NOTE: Before starting the installation, check the function of the vehicle (horn, lights, etc.) for proper operation, and study the instructions, illustrations, photos & diagrams.

Perform the following:

1. Disconnect the battery and remove it from the vehicle.
2. Drain the radiator.
3. Remove the OEM heater hoses from the intake, water pump and firewall (See Photo 1, below).
4. Jack up the vehicle and support it with jack stands, then remove the passenger-side front wheel (See Photo 2, below).
5. Remove the battery tray and all mounting bolts to the passenger-side inner fender, then carefully lower and remove the inner fender (See Photo 3, below).
6. Remove the (2) inner fender bracket bolts, then remove the bracket (retain) (See Photo 4, below).
7. Disconnect the blower power wire.
8. Remove the (7) blower mounting bolts, then remove the blower assembly (discard). **NOTE:** To remove the evaporator and blower assembly (under the hood), and the air distribution system (under the dash), the factory manual recommends removing the passenger-side inner fender.
9. Remove the (3) fresh air duct mounting screws (See Photo 5, below).

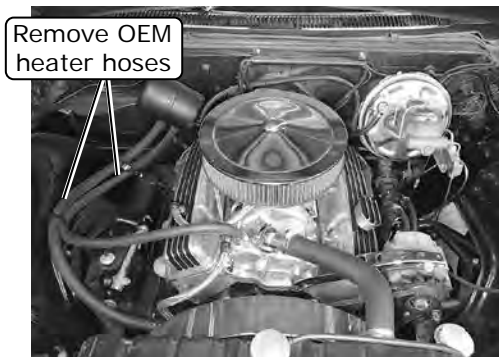

Photo 1



Photo 2

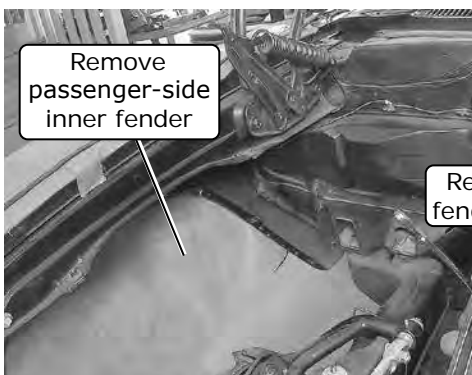

Photo 3

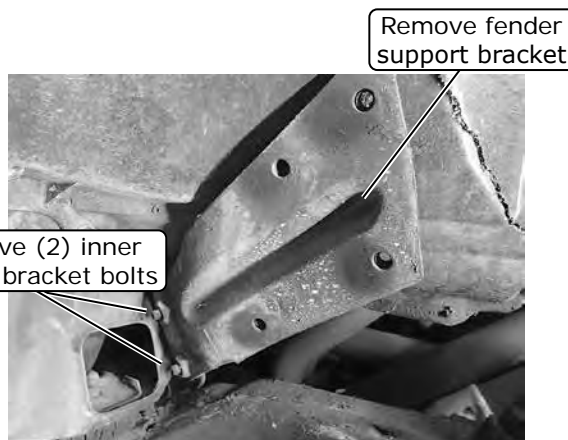

Photo 4

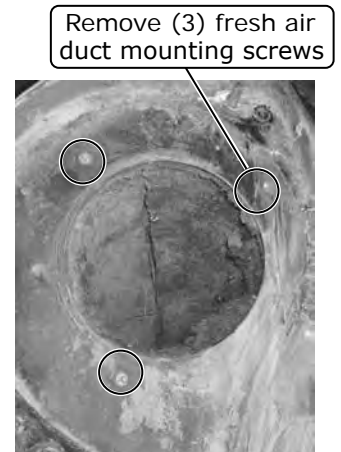

Photo 5



www.vintageair.com

Condenser Assembly and Installation

1. Refer to separate instructions included with the condenser kit to install the condenser.
2. Binary switch installation (Refer to condenser instructions).

Compressor and Brackets

1. Refer to separate instructions included with the bracket kit to install the compressor bracket.

Passenger Compartment Disassembly

NOTE: Removal of the dash bezel is optional, but is recommended.

Perform the following:

1. Remove the glove box door by removing (3) screws. Remove the (4) glove box mounting screws, then remove the glove box (discard) (See Photo 1, below).
2. From the back of the dash, disconnect the speedometer cable (See Photo 2, below), gauge wiring (See Photos 3 and 4, below) and the stereo connections.

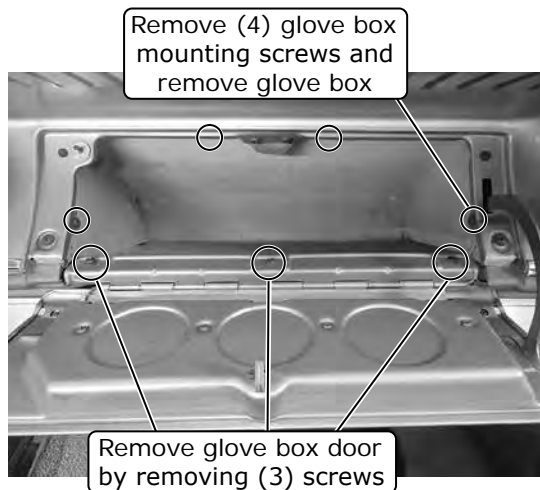

Photo 1

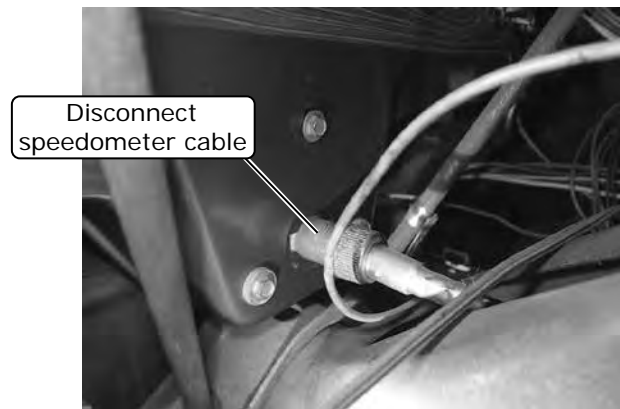

Photo 2



Photo 3



Photo 4

Passenger Compartment Disassembly (Cont.)

3. Remove the (14) dash bezel mounting screws and carefully remove the dash bezel (See Photos 5, 6, 7 and 8, below). **NOTE: It may be necessary to move the gear selector all the way down to remove the dash bezel. Ensure to engage the parking brake before doing so for safety.**
4. Remove the (2) control panel mounting screws from the lower dash (retain screws) (See Photo 9, below). Disconnect the (2) lights, plugs, cables and vacuum lines from the panel, then carefully remove the control panel from the dash.
5. Disconnect the plugs and cable holders from the heater core housing, then remove the housing from the vehicle.
6. Remove the (3) defrost duct mounting screws, then remove the duct from the dash (discard) (See Photos 10, 11 and 12, below).
7. Discard all vacuum lines and connections, as they will no longer be needed.



Photo 5

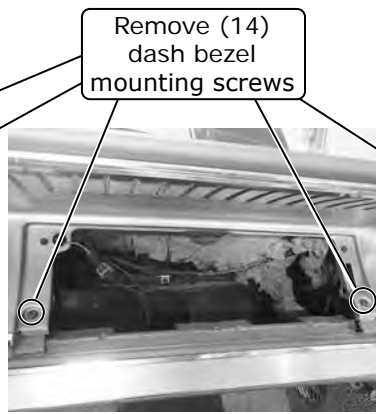

Remove (14) dash bezel mounting screws

Photo 6

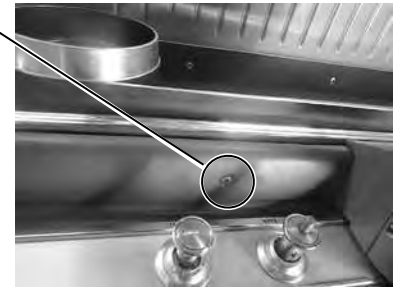
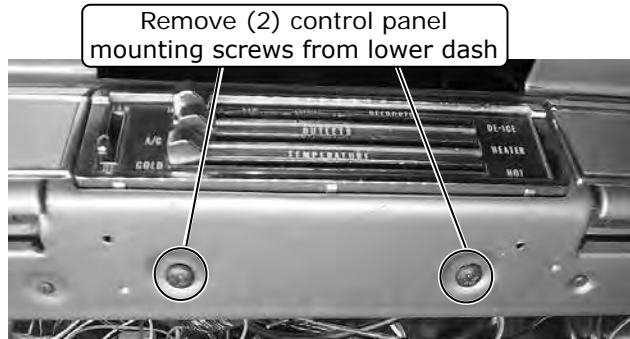

Photo 7



Remove (14) dash bezel mounting screws

Photo 8



Remove (2) control panel mounting screws from lower dash

Photo 9

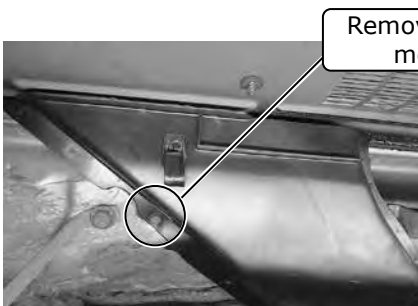

Remove (3) defrost duct mounting screws

Photo 10

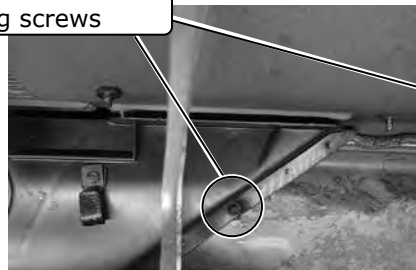
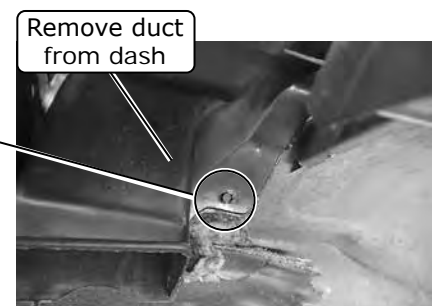

Photo 11



Remove duct from dash

Photo 12



www.vintageair.com

Passenger Compartment Disassembly (Final)

8. Remove the (5) door sill plate screws, then remove the plate (retain) (See Photo 13, below).
9. Remove the (3) kick panel screws and remove the kick panel from the vehicle (retain) (See Photos 14 and 15, below).
10. Remove the cable strap screw, then remove the cable from the fresh air door. Remove the cable from the dash bracket. Install a 1/2" plastic cap into the dash bracket.
11. Remove the (6) fresh air vent assembly screws, then carefully twist and remove the assembly from the kick panel (discard) (See Photo 16, below).
12. Vacuum out the kick panel area.
13. Remove the retainer as shown in Photo 17, below.
14. Remove the OEM insulation as shown in Photo 17, below.

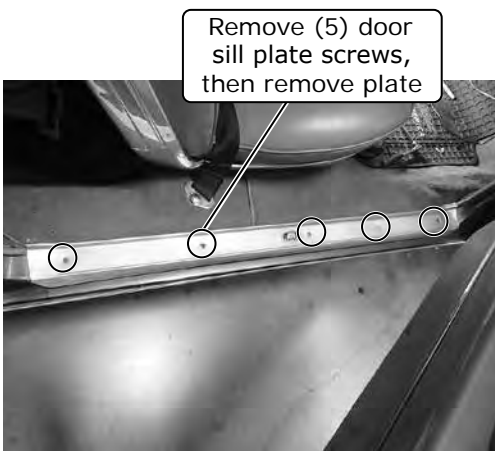

Photo 13

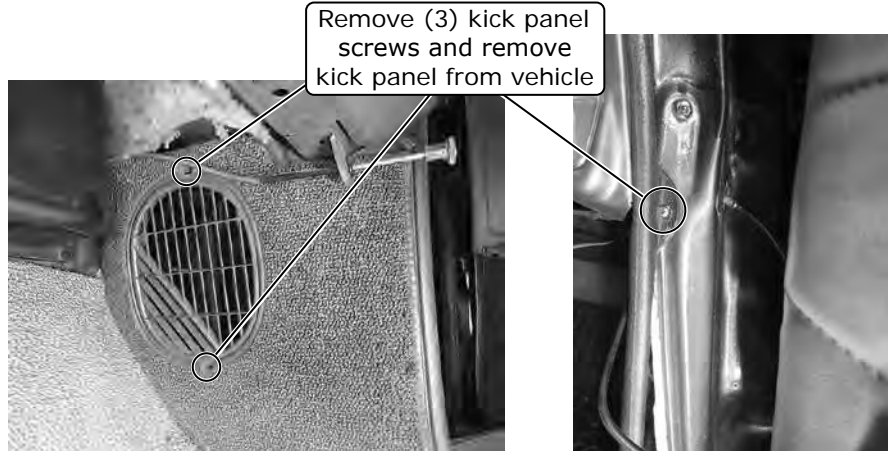

Photo 14

Photo 15

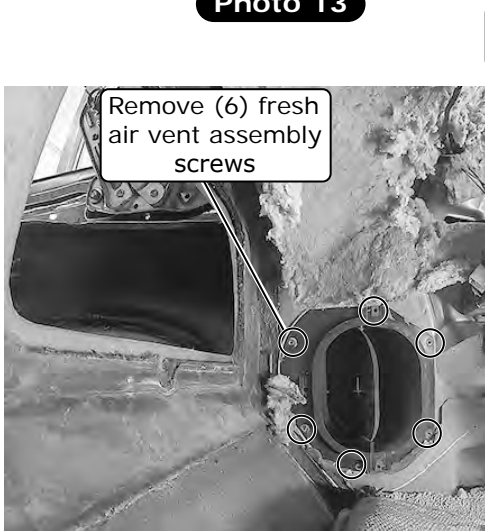

Photo 16

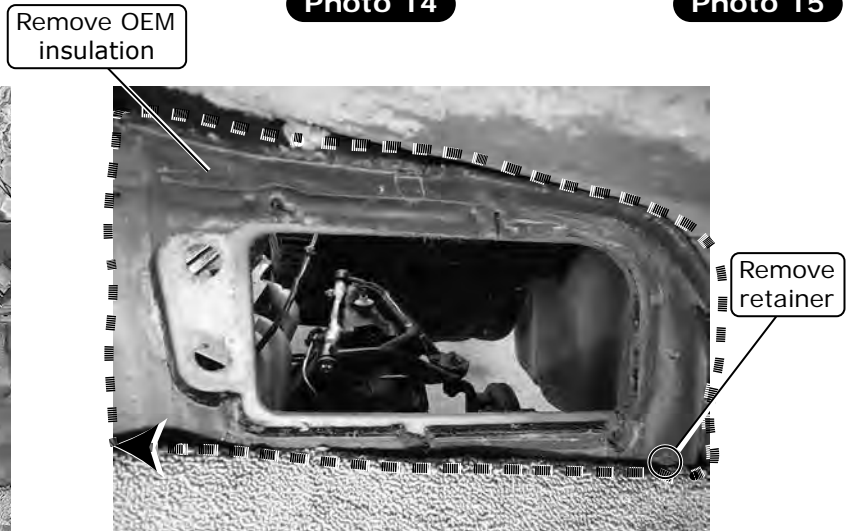

Photo 17



www.vintageair.com

Kick Panel Modification

NOTE: Some or all of the kick panel grille may be removed in this step depending on the desired look, align the kick panel cover behind the kick panel to see how much of the grille will have to be removed.

1. Remove the grille material on the kick panel (See Photos 1 and 2, below). **NOTE:** The A/C and heater hoses will run through this opening.

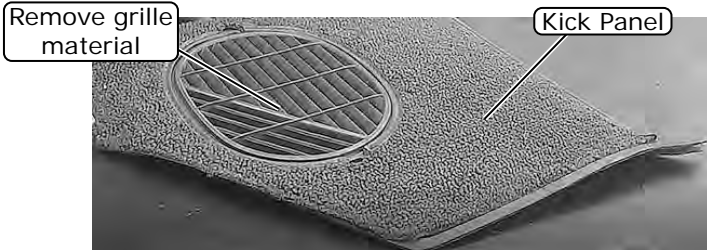

Photo 1

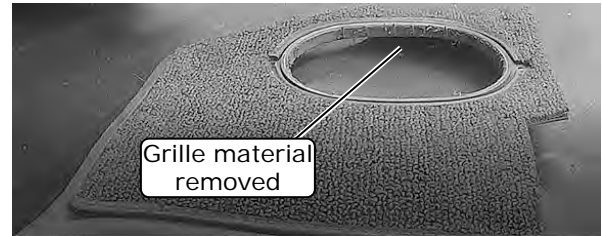

Photo 2

Firewall Cover Preparation

1. Install (2) 1/4-20 x 3/4" serrated flange black bolts with (2) 1/4" pushnut bolt retainers as shown in Photos 1 and 2, below.

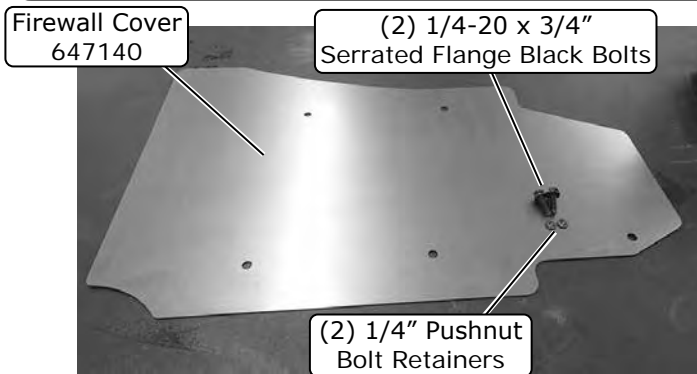

Photo 1

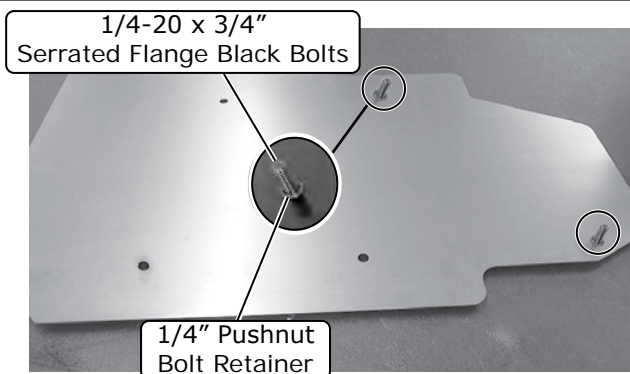

Photo 2

Firewall Modification

NOTE: The firewall requires modification for the firewall cover and drain hose to be installed.

Perform the following:

1. Flatten the edges of the firewall opening (See Photo 1, below).
2. Enlarge the (5) holes on the firewall using a 5/16" drill bit (See Photo 1, below). **NOTE:** Some holes may already be 5/16" or larger.
3. Using the floor pan bead roll for reference, on the flat portion of the floor pan, measure a 1" from the right and 3/4" from the firewall. Drill a 5/8" hole for the drain tube (See Photos 2 and 3, below). **NOTE:** To ensure a tight fit for the drain hose, do not enlarge the hole more than 5/8".

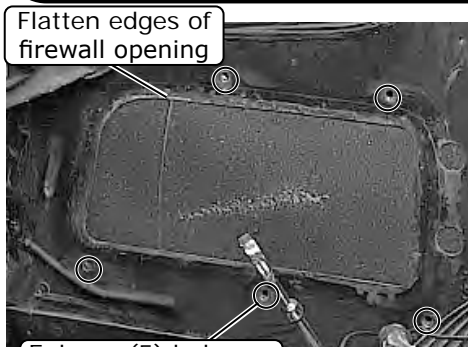

Photo 1

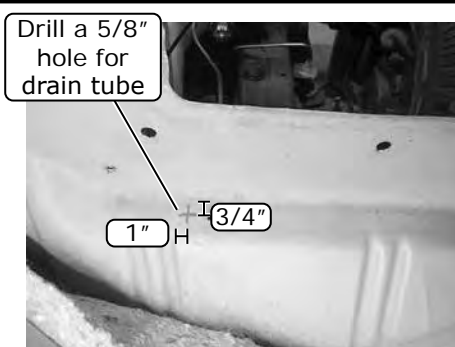

Photo 2



Photo 3



www.vintageair.com

Firewall Cover Installation

NOTE: For proper system operation, Vintage Air recommends using heat-blocking insulation in the area around the evaporator unit (firewall, kick panel, inner cowl, firewall covers). To ensure a watertight seal between the passenger compartment and the vehicle exterior, for all bolts passing through the firewall, Vintage Air recommends coating the threads with silicone prior to installation.

1. Apply a bead of silicone around the mating surface of the firewall cover (See Photo 1, below).
2. Install the firewall cover onto the firewall using (2) 1/4-20 x 3/4" serrated flange black bolts that were previously installed (See Figure 1, below). From the passenger compartment, install (2) 9/32" flat washers and secure using (2) 1/4-20 hex nuts with star washers (See Figure 1, below).
3. Using the firewall cover as a template, drill (2) pilot holes as shown in Photo 1, below, using a 1/8" drill bit then install (2) #14 x 3/4" washer head screws (See Photo 3, below).
4. Apply heat-blocking insulation at this time (See Photo 4, below).

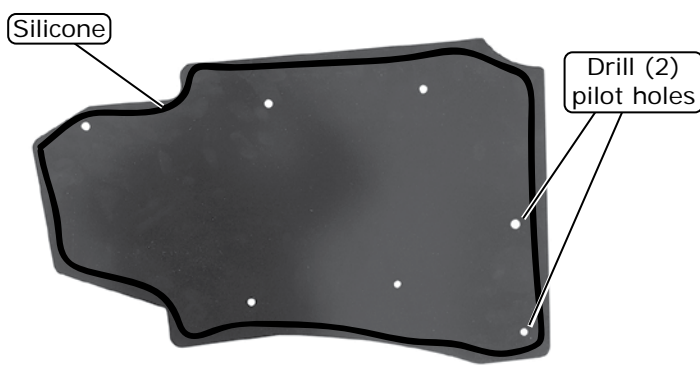

Photo 1

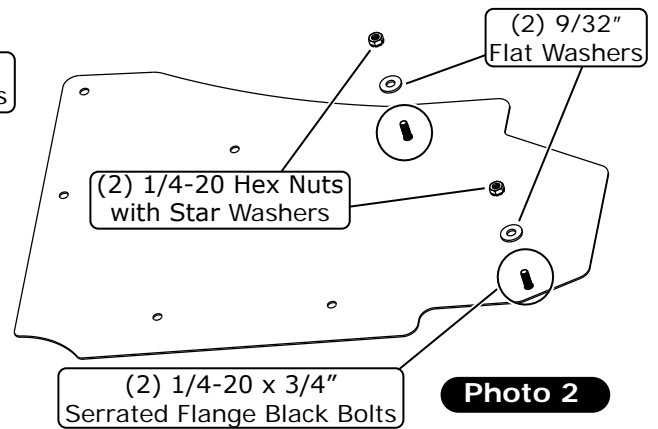

Photo 2

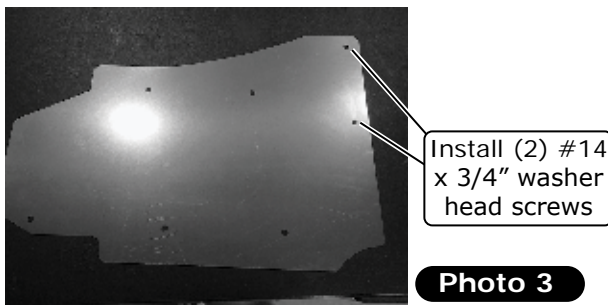
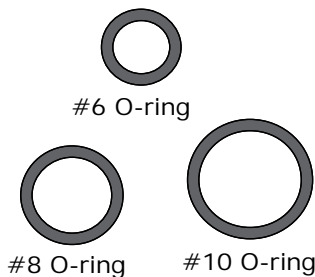

Photo 3

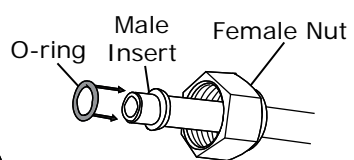

Photo 4

Lubricating O-rings



NOTE: Standard torque specifications:
 #6: 11 to 13 ft-lb.
 #8: 15 to 20 ft-lb.
 #10: 21 to 27 ft-lb.



For a proper seal of fittings: Install supplied O-rings as shown and lubricate with refrigerant oil.

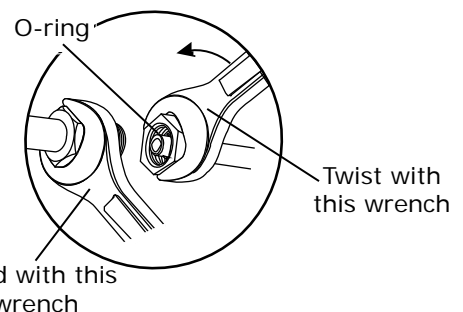
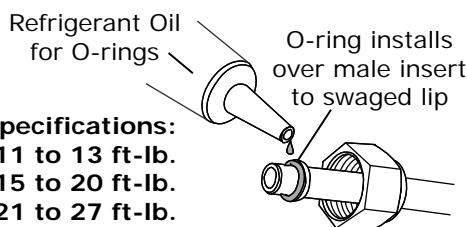



www.vintageair.com

Properly Seated O-ring Land

When installing a hardline or A/C hose fitting onto the evaporator module, ensure the O-ring land is seated properly (See Photo 1, below). An improperly seated O-ring land (See Photo 2, below) can cause a leak. To properly install the fitting, slide the hardline or A/C hose nut back to expose the O-ring land and seat it onto the evaporator module fitting. Then, slide the hardline or A/C hose nut forward and thread it onto the evaporator module fitting, ensuring the O-ring land does not move or lift.

Properly Seated O-ring Land



Photo 1

Improperly Seated O-ring Land



Photo 2

NOTE: Photos shown are for reference only. Fittings may vary depending on kit received.

Evaporator Preparation

Perform the following on a workbench:

1. Install (3) 1/2" plastic plugs into the back (See Photos 1 and 2, below). NOTE: These mounting positions will not be used for this application.
2. Remove the plastic caps and rubber inserts from the heater coil (See Photos 3 and 4, below), and install the upper and lower 45° heater fittings onto the evaporator module (See Photo 5, below) using (2) properly lubricated #10 O-rings (See Lubricating O-rings, Page 11).

Install (3) 1/2" plastic plugs into back of evaporator module

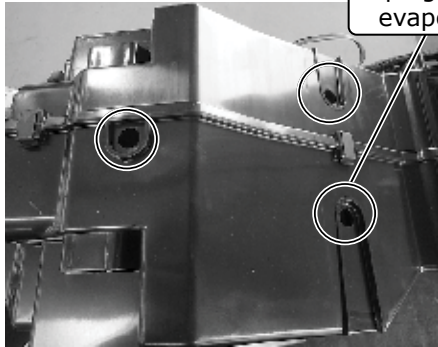

Photo 1

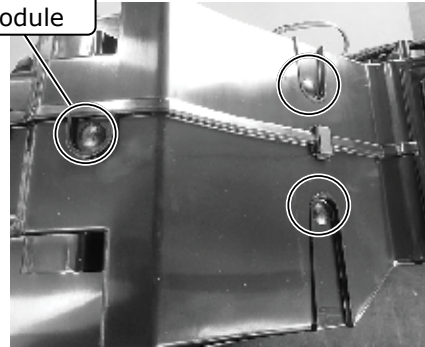

Photo 2

Remove plastic caps and rubber inserts from heater coil

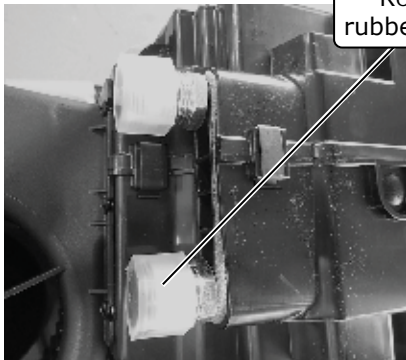

Photo 3

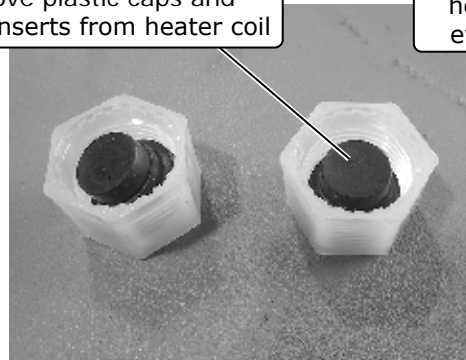

Photo 4

Install upper and lower heater fittings onto evaporator module

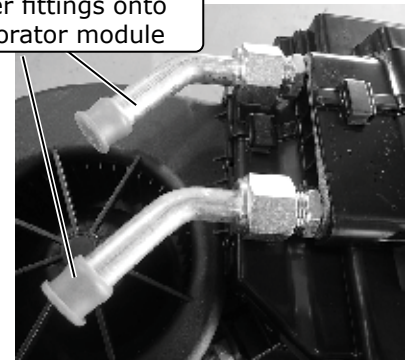

Photo 5



www.vintageair.com

Evaporator Preparation (Cont.)

3. Install the evaporator firewall bracket onto the module and secure it using (4) #10 x 5/8" screws (See Photos 6 and 7, below).
4. Install (2) 1/4-20 x 1" full-threaded studs into the upper and lower mounting holes on the evaporator firewall bracket (See Photo 8, below). **NOTE: Allen head should be facing out. Once module is in place, using an Allen key to remove the studs might be necessary.**
5. Install the defrost plenum onto the back of the evaporator module using (2) spring clips (See Photo 9, below).
6. Install the dash plenum onto the evaporator module using (4) spring clips (See Photos 10 and 11, below).
7. Install the floor plenum onto the front of the evaporator module using (2) spring clips (See Photo 12, below).

Evaporator Firewall Bracket
643220

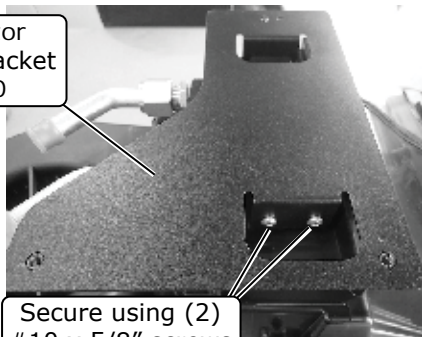

Secure using (2)
#10 x 5/8" screws

Photo 6

Secure using
(2) #10 x 5/8"
screws

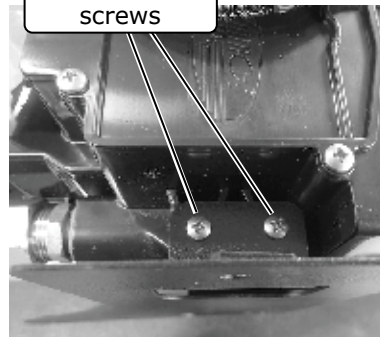
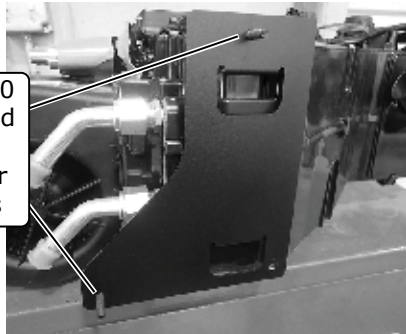

Photo 7

Install (2) 1/4-20
x 1" full-threaded
studs into
upper and lower
mounting holes



Dash Plenum
625330

Photo 8

Defrost Plenum
625331

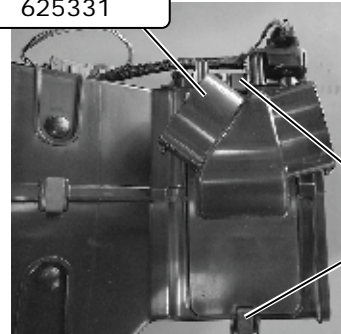

Using (2) spring
clips, install
defrost plenum

Photo 9

Floor Plenum
625340

Using (2)
spring clips,
install dash
plenum

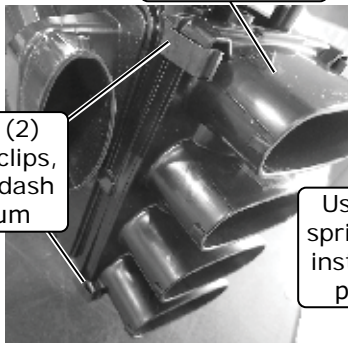

Photo 10

Using (2)
spring clips,
install dash
plenum

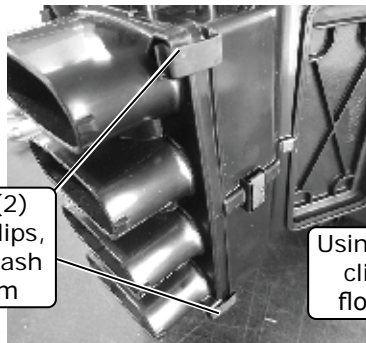

Photo 11

Using (2) spring
clips, install
floor plenum

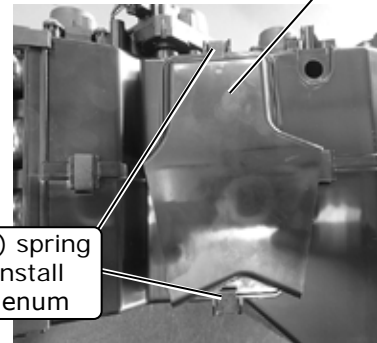

Photo 12



www.vintageair.com

Fresh Air Cap & Kick Panel Preparation

1. Install (3) large, (1) 1 1/4" O.D. and (1) 7/8" O.D. grommets into the fresh air cap (See Photos 1 & 2, below).
NOTE: Check the orientation of the fresh air cover against the opening in the firewall before installing the grommets.
2. On the inside of the fresh air cap, the letter "T" indicates the top mounting hole for the firewall (See Photo 3, below).
3. Install (3) large, (1) 1 1/4" O.D. and (1) 7/8" O.D. grommets into the kick panel cover (See Photos 4 and 5, below).



Photo 1

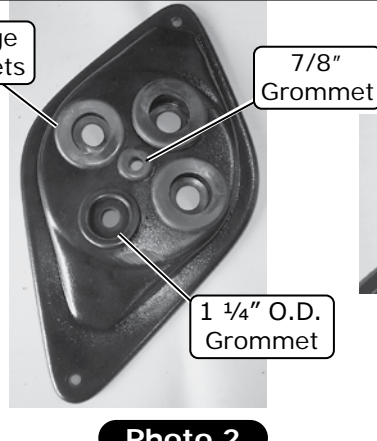

Photo 2

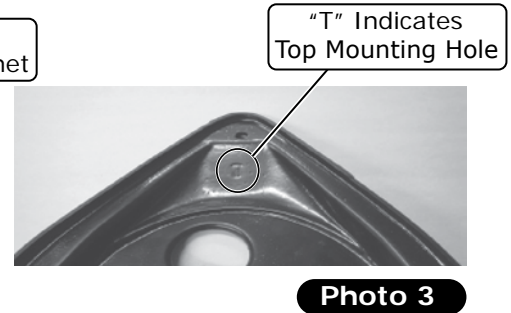

Photo 3

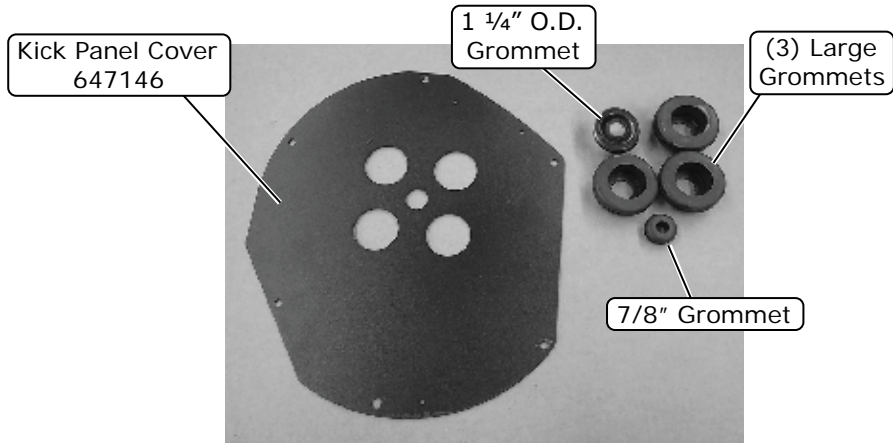

Photo 4



Completed Installation

Photo 5

Defrost Duct Installation

1. Align the defrost duct assembly onto the OEM mounting holes and secure it using (2) #10 x 1/2" sheet metal screws (See Photo 1, below).

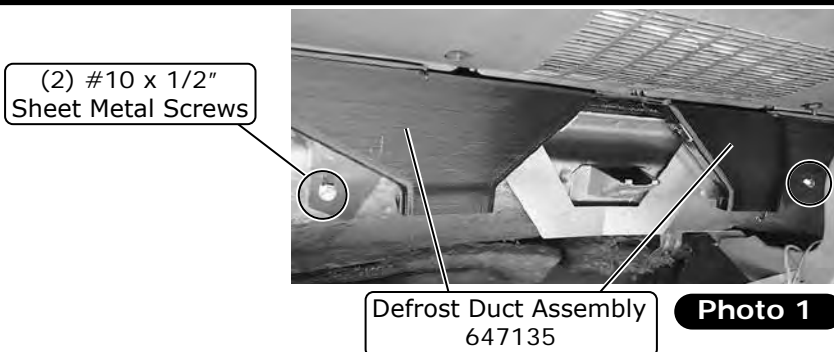

Photo 1



www.vintageair.com

Wiring Installation

1. From the passenger compartment, route the heater control valve connector (yellow, purple and white) and wiring (red, white and blue) through the 7/8" grommet in the kick panel cover (See Photo 1, below).
NOTE: Leave approximately 16" between the grommet and relay.
2. Route the wiring through the kick panel opening and into the engine compartment.
3. Route the heater control valve connector (yellow, purple and white) and wiring (red, white and blue) through the 7/8" grommet in the fresh air cap (See Photo 2, below).
4. Mount the relay and ground ring terminal in a suitable location. Secure the relay with a #10 x 1/2" sheet metal screw and the ground eyelet with a #12 x 1/2" self-tapping screw (See Photo 3, below).

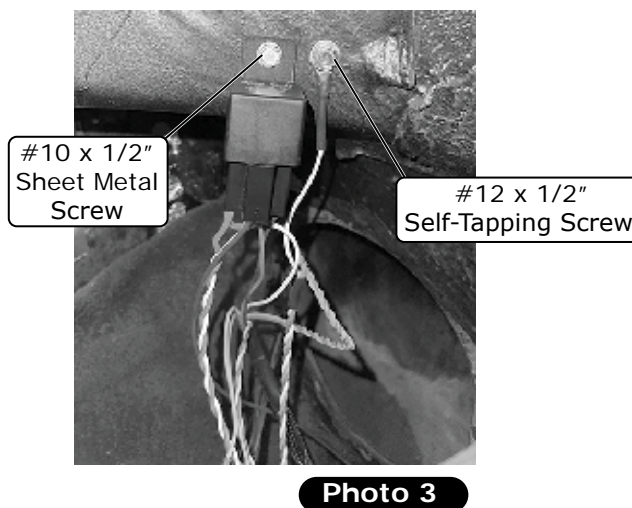
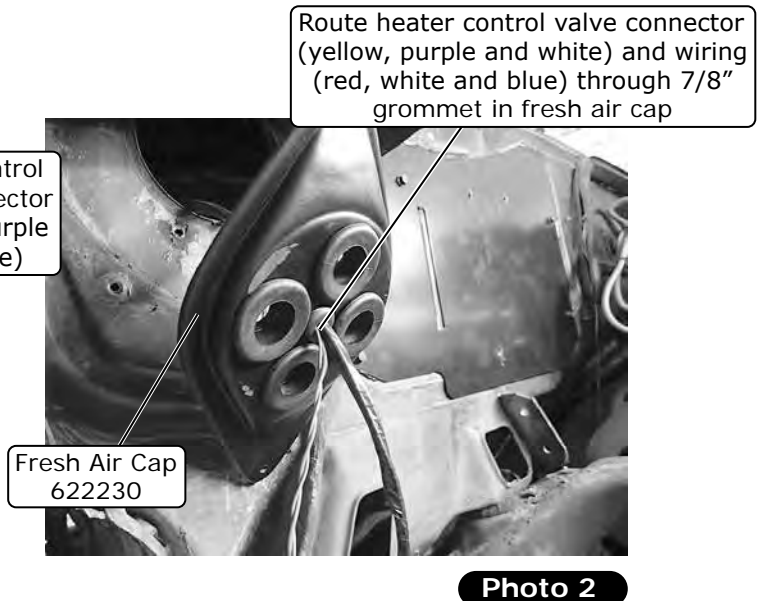
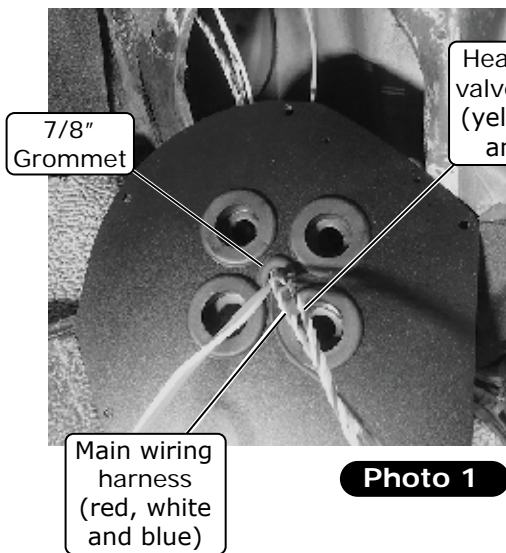



www.vintageair.com

A/C & Heater Hoses and Kick Panel Cover Installation

NOTE: All hoses install through the fresh air cap large grommets, then into the opening in the engine compartment through the kick panel opening. Be sure the fresh air cap is in the proper position before installing hoses.

1. Insert a length of heater hose through the top-right large grommet on the fresh air cap (See Photo 1, below).
2. Insert a length of heater hose through the bottom-right large grommet on the fresh air cap (See Photo 1, below).
3. Insert the 45° fitting of the #6 drier/evaporator A/C hose through the bottom-left large grommet on the fresh air cap (See Photo 1, below).
4. Insert the 45° fitting on the #10 compressor/evaporator A/C hose through the top-left large grommet on the fresh air cap (See Photo 1, below).
5. Insert the first heater hose through the top-left large grommet on the kick panel cover (See Photo 2, below).
6. Insert the second heater hose through the bottom-left large grommet on the kick panel cover (See Photo 2, below).
7. Insert the 45° fitting of the #6 drier/evaporator A/C hose through the bottom-right large grommet on the kick panel cover (See Photo 2, below).
8. Insert the 45° fitting on the #10 compressor/evaporator A/C hose through the top-right large grommet on the kick panel cover (See Photo 2, below). **NOTE: Temporarily remove the large grommet from the kick panel cover to ease the insertion of the #10 hose fitting.**

Insert 45° fitting on #10 compressor/evaporator A/C hose through top-left large grommet

Insert length of heater hose through top-right large grommet

Insert length of heater hose through bottom-right large grommet

Insert length of heater hose through top-left large grommet

Insert 45° fitting on #10 compressor/evaporator A/C hose through top-right large grommet

Fresh Air Cap
622230

Insert 45° fitting of #6 drier/evaporator A/C hose through bottom-left large grommet

Photo 1

Insert length of heater hose through bottom-left large grommet

Insert 45° fitting of #6 drier/evaporator A/C hose through bottom-right large grommet

Photo 2



www.vintageair.com

A/C & Heater Hoses and Kick Panel Cover Installation (Cont.)

9. Apply a 1/4" bead of silicone around the mating surface of the kick panel cover (See Photo 3, below).
10. Secure the kick panel cover using the OEM screws (See Photo 4, below).
11. Install the kick panel using (2) #8 x 1 1/4" countersunk screws with washers (See Photo 5, below).

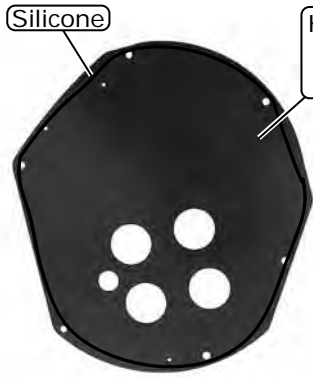
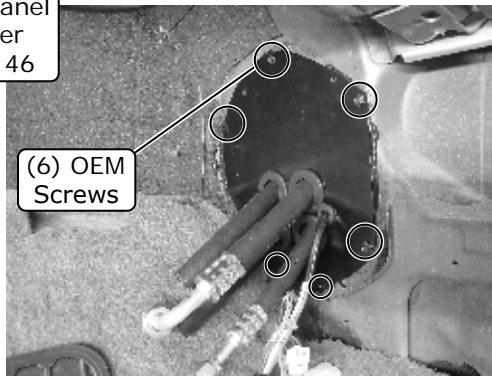

Photo 3

Kick Panel Cover
647146



(6) OEM
Screws

Photo 4

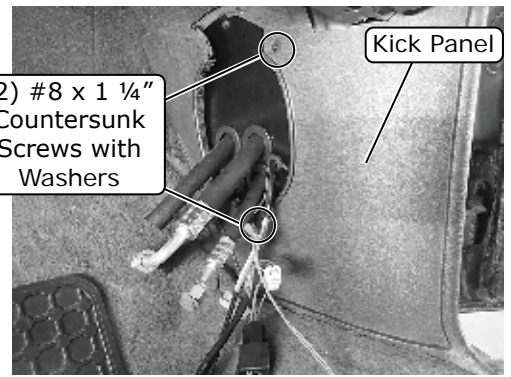

(2) #8 x 1 1/4"
Countersunk
Screws with
Washers

Kick Panel

Photo 5

Evaporator & A/C Hose Installation

NOTE: To ensure a watertight seal between the passenger compartment and the exterior, for all bolts passing through the firewall, Vintage Air recommends coating the threads with silicone prior to installation. Be sure to use a backup wrench when connecting A/C hoses and hardlines to avoid damaging hose fittings.

1. Place the evaporator on the passenger-side floorboard, route the heavy gauge orange and white wires through the wiring grommet in the kick panel cover into the kick panel opening.
2. Route orange and white wires through the kick panel opening into the wiring grommet in the fresh air cap.
3. Install the upper and lower heater hoses onto the upper and lower 45° heater hardlines on the evaporator module, then secure them using (2) #12 hose clamps (See Photo 1, below).
4. Lift the evaporator module into place, using the (2) 1/4-20 full-threaded studs on the evaporator firewall bracket to locate the mounting holes (See Photo 2, below). **NOTE: A 2 x 4 board may be used to support the evaporator module in place while the next steps are completed.**

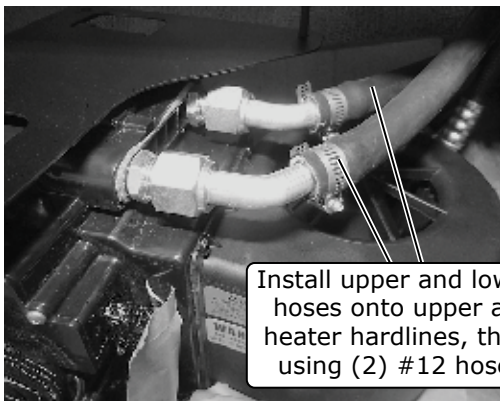

Install upper and lower heater hoses onto upper and lower heater hardlines, then secure using (2) #12 hose clamps

Photo 1

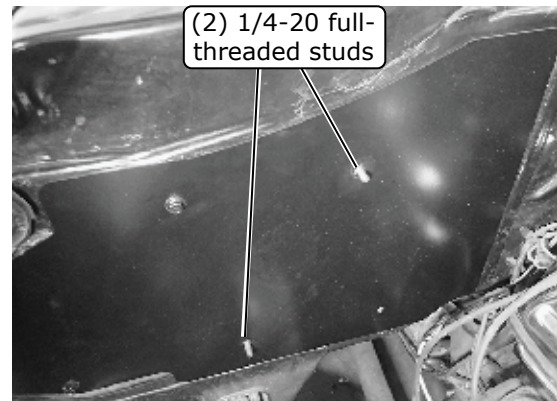

(2) 1/4-20 full-
threaded studs

Photo 2



www.vintageair.com

Evaporator & A/C Hose Installation (Cont.)

5. Install (2) 1/4-20 well nuts into the mounting provisions of the module (See Photos 3 and 4, below).
6. Loosely install the cowl bracket onto the evaporator using (2) 1/4-20 x 1" serrated flange bolts (See Photo 5, below).
7. From the engine compartment, install (3) 1/4-20 x 3/4" serrated flange black bolts, replacing the (2) 1/4-20 x 1" full-threaded studs (See Photo 6, below). **NOTE: Do not fully tighten at this time.**
- NOTE: To ensure proper drainage, it is important that the evaporator is level, both left-right and fore-aft. Check for level on the flat portions of the case around the drain**
8. Once the evaporator module is leveled, using (2) #12 x 1/2" self-tapping screws secure the front mounting bracket to the cowl (See Photo 7, below). Tighten all mounting hardware, (3) bolts on the firewall and (2) on the evaporator module.
9. Using a properly lubricated #6 O-ring (See Lubricating O-rings, Page 11) install the 45° fitting of the #6 drier/evaporator A/C hose onto the block adapter on the evaporator module (See Photo 8, below).
10. Using a properly lubricated #10 O-ring (See Lubricating O-rings, Page 11) install the 45° fitting of the #10 compressor/evaporator A/C hose onto the block adapter on the evaporator module (See Photo 9, below).
11. Once the #10 fitting is installed, wrap all exposed metal with the supplied press tape (See Photo 10, below).

Install (2) 1/4-20 well nuts into front mounting provisions

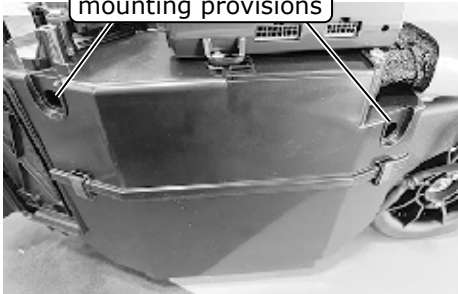

Photo 3

(2) 1/4-20 Well Nuts

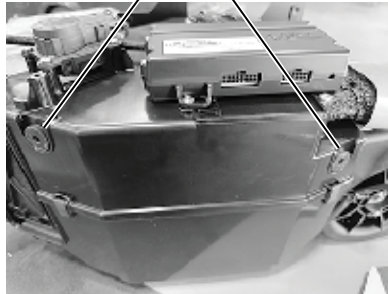

Photo 4

Install (2) 1/4-20 x 1" serrated flange bolts into well nuts

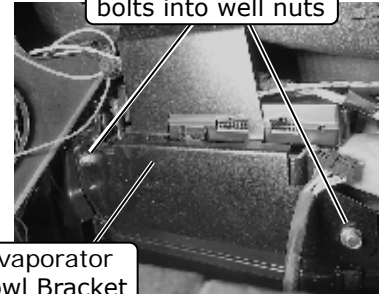

Photo 5

Evaporator Cowl Bracket 648242

Replace with (2) 1/4-20 x 3/4" serrated flange black bolts

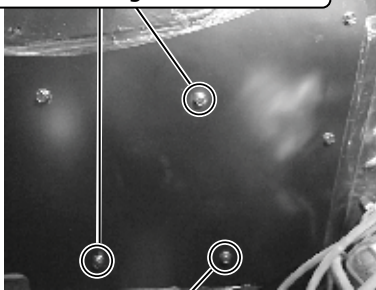

Photo 6

(2) #12 x 1/2" Self-Tapping Screws

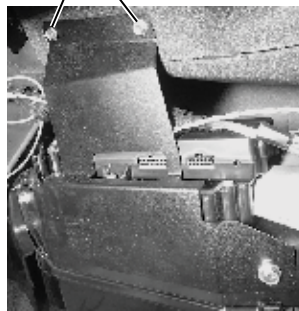

Photo 7

Install 45° fitting of #6 drier/evaporator A/C hose onto block adapter



Photo 8

Install 1/4-20 x 3/4" serrated flange black bolt

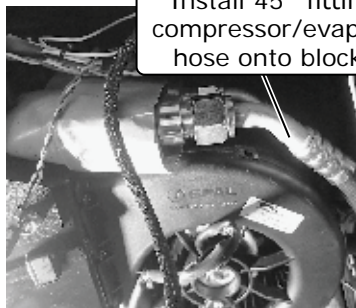

Photo 9

Install 45° fitting of #10 compressor/evaporator A/C hose onto block adapter

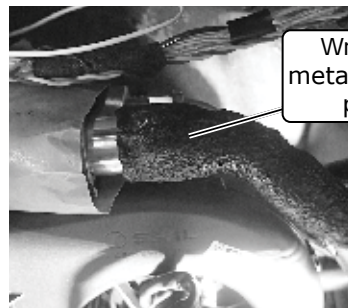

Photo 10

Wrap exposed metal with supplied press tape



www.vintageair.com

Drain Hose Installation

1. Locate the evaporator drain on the bottom of the evaporator case.
2. Install the drain hose onto the outlet on the evaporator unit, and route it through the previously drilled 5/8" hole on the lower firewall (See Photo 1, below).

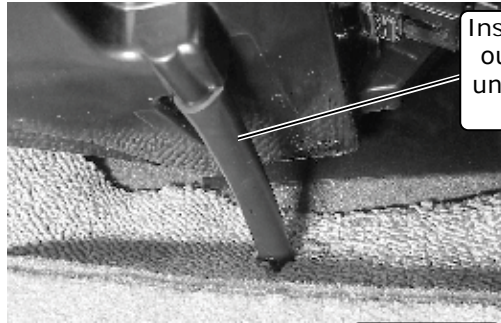

Install drain hose onto outlet on evaporator unit and through 5/8" hole on firewall

Photo 1

ECU Wiring Harness Installation

1. Connect the main harness plug to the ECU (See Photo 1, below). Locate the control panel plug and connect it to the ECU (follow steps included with control panel instructions) (See Photo 1, below).
2. Connect the blower speed controller plug into the main wiring harness plug (orange and green wires) (See Photo 2, below).
3. Route the violet power wire to a switched 12v power source on the fuse panel (See Photo 3, below).
NOTE: This requires a male fuse extension (not supplied).
4. Connect the tan wire to the factory dash lights to enable control panel backlighting.

Connect main harness plug to ECU

Connect control panel harness plug to ECU

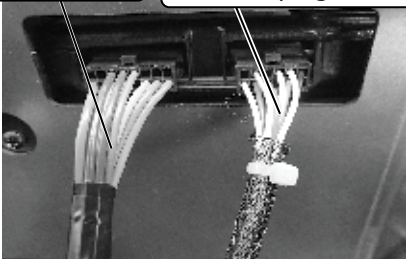

Photo 1

Connect blower speed controller plug into main wiring harness plug (orange and green wires)

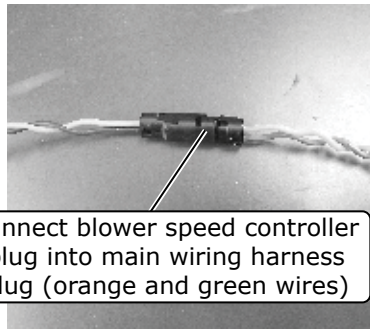

Photo 2

Attach Violet Wire to Switched Power Source

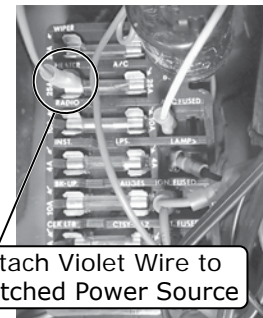

Photo 3

Control Panel Installation

NOTE: Follow the instructions provided with the new control panel kit before continuing with the installation.

1. Install the new control panel into the OEM mounting location. Do not secure it at this time (See Photo 1, below).

Install new control panel into OEM mounting location

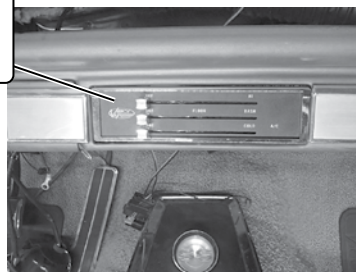

Photo 1



www.vintageair.com

Under Dash Louver Preparation and Installation

NOTE: If your vehicle is equipped with a power antenna or convertible top switch, it will have to be relocated to the bottom of the under dash louver. The following instructions are for switch relocation, if there is no switch in your vehicle proceed to Step 6.

1. Remove the switch from the under dash and retain the hardware (See Photo 1, below).
2. Locate the under dash portion of the driver-side under dash louver bezel.
3. Select a location on the bottom side of the louver bezel for the switch (See Photo 2, below). **NOTE: Confirm there is enough wiring to reach the selected location.**
4. Place the switch bezel on the bottom side of the louver bezel and mark the areas to be drilled and removed (See Photo 3, below).
5. Remove the switch bezel then using a 3/16" drillbit, drill mounting holes for the OEM hardware and remove the marked area for the switch (See Photo 4, below).
6. Locate the (2) dimples on the bottom of the dash, below the ignition switch. Using a 3/16" drillbit, drill out the dimple to the left of the dash (See Photo 5, below).
7. Insert the driver-side louver support bracket into the driver-side louver bezel (See Photo 6, below).
8. Install the passenger-side louver support bracket into the passenger-side louver housing (See Photo 7, below).
9. Connect the driver- and passenger-side louvers (See Photo 7, below). Insert the passenger-side louver support bracket and secure it using (2) 10-24 x 1/2" pan head screws and (2) 10-24 nuts with star washers (See Photos 8 and 9, below).

Remove switch from under dash and retain hardware

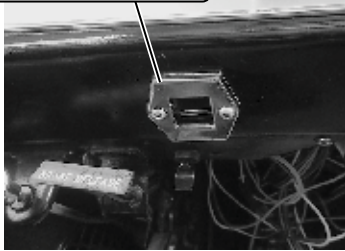

Photo 1

Select location on bottom side of louver bezel for switch

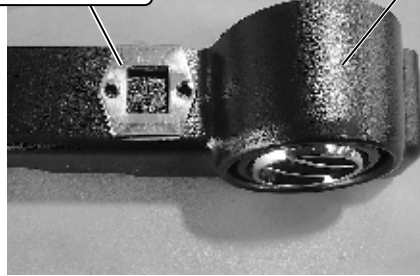

Photo 2

Driver-Side Under Dash Louver Bezel 621030

Mark areas to be drilled and removed

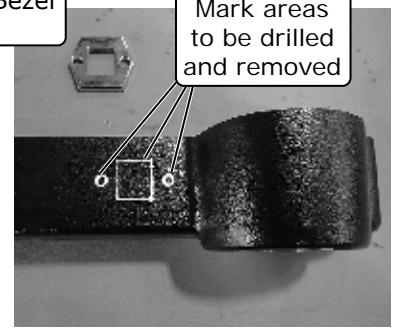

Photo 3

Mounting holes drilled

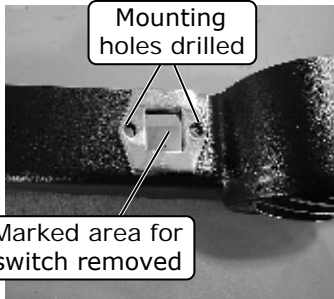

Photo 4

Marked area for switch removed

Using 3/16" drillbit drill out dimple to the left

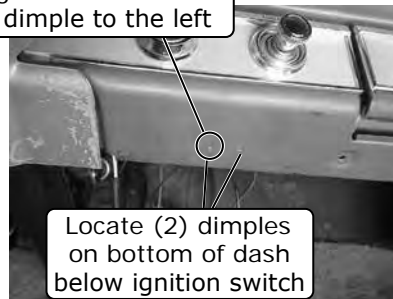

Photo 5

Locate (2) dimples on bottom of dash below ignition switch

Insert driver-side louver support bracket into driver-side louver bezel



Photo 6

Connect driver- and passenger-side louvers

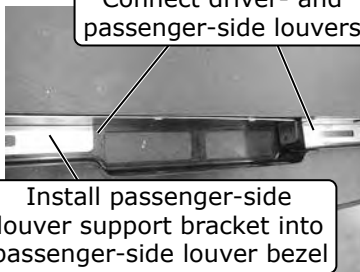

Photo 7

Install passenger-side louver support bracket into passenger-side louver bezel

Secure using (2) 10-24 x 1/2" pan head screws



Photo 8

Secure using (2) 10-24 nuts with star washers



Photo 9



www.vintageair.com

Under Dash Louver Preparation and Installation (Cont.)

10. Install the (2) 1/4-20 x 3/4" pan head screws into the louver bezel and secure them using (2) 1/4" pushnut bolt retainers (See Photo 10, below). **NOTE: Bolts located with Control Panel Kit.**
11. Install (2) 10-32 x 1/2" pan head screws through the driver-side louver housing and support bracket and secure them using (2) 3/16" push-on rings (See Photo 11, below).
12. Loosely install the under dash louver assembly using the installed 1/4-20 x 3/4" pan head screws into the control panel and the (2) 10-32 x 1/2" pan head screws through the holes in the dash on the driver side and secure using 10-32 nuts with star washers.
13. Using a 3/16" drillbit and the under dash louver as a template, adjust the louver housing against the dash evenly and drill the last mounting point on the passenger side (See Photo 12, below), then secure the under dash louver assembly using a 10-32 x 1/2" pan head screw and a 10-32 nut with star washer. Tighten all hardware at this time.
14. Install the power antenna or convertible top switch using the OEM hardware (if applicable) (See Photo 13, below).

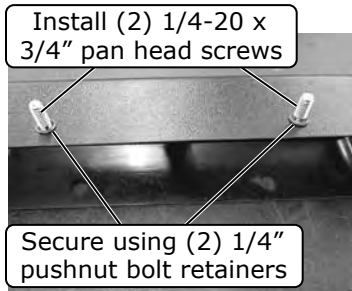

Photo 10

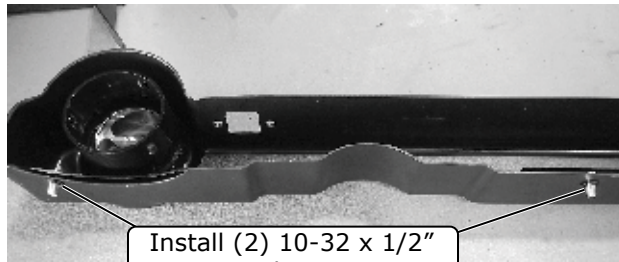

Photo 11

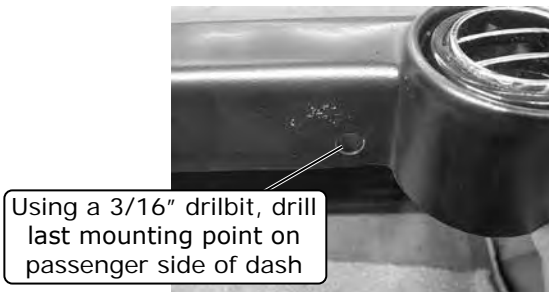

Photo 12

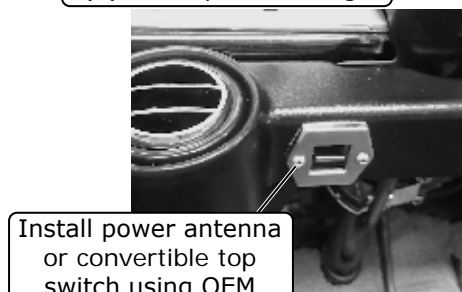

Photo 13

Fresh Air Cap Installation

NOTE: The fresh air cap installs on the engine side of the firewall.

1. Gently pull the slack from the hoses in the passenger compartment, making sure the hoses are not kinked.
2. Slide the fresh air cap into position, and secure it to the firewall using (2) #14 x 3/4" washer head screws (See Photo 1, below).
3. Apply silicone around the outer edge of the fresh air cap (See Photo 1, below).

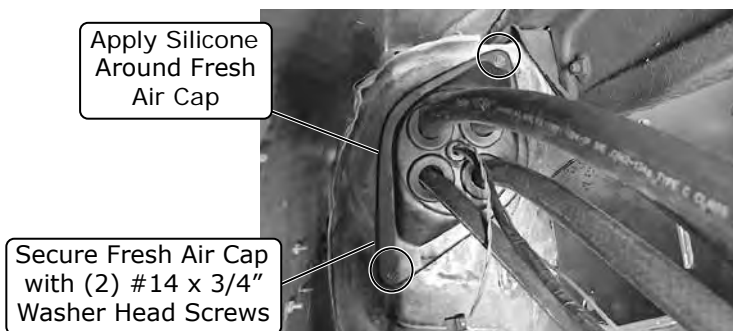

Photo 1



www.vintageair.com

Heater Control Valve Installation

NOTE: Vintage Air systems use 5/8" heater connections. On engines equipped with 3/4" hose nipples, these will need to be removed and replaced with 5/8" nipples (not supplied). For water pumps with a cast-in 3/4" heater outlet, a 3/4" x 5/8" reducer fitting (not supplied) or molded hose will need to be installed in the heater hose.

1. Cut the upper heater hose approximately 4 to 5 inches from the fresh air cap (See Photo 1, below). Install the heater control valve (See Photo 2, below). **NOTE: Ensure proper flow direction through the heater control valve. The flow direction follows the molded arrow on the valve (See Figure 1, below).**
2. Install another length of heater hose onto the heater control valve and secure using the provided hose clamp (See Photo 3, below).
3. Plug the heater control valve connector into the connector on the main wiring harness.
4. Reinstall the inner fender at this time, routing the heater and A/C hoses and wiring toward the front of the vehicle.
5. Install the lower heater hose onto the the water pump and secure with a hose clamp (See Photo 4, below).
6. Install the upper heater hose to the intake and secure with a hose clamp (See Photo 5, below).

Cut upper heater hose approximately 4 to 5 inches from fresh air cap



Photo 1



Photo 2

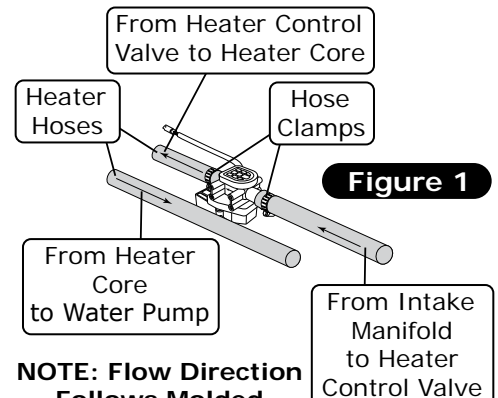

Figure 1

NOTE: Flow Direction Follows Molded Arrow on Valve



Photo 3

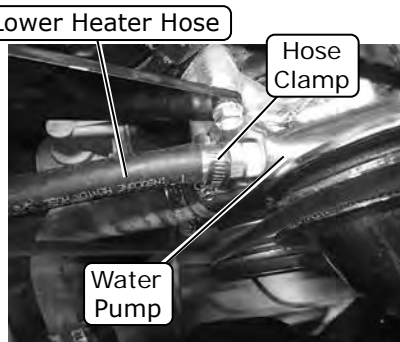

Photo 4

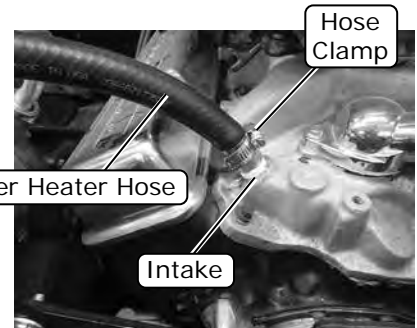

Photo 5



www.vintageair.com

Inner Fender Reinstallation

1. Reinstall the inner fenderwell at this time using OEM hardware.

A/C Hose Installation

1. Locate the #10 compressor/evaporator A/C hose. Lubricate a #10 O-ring and connect the 90° fitting with service port to the #10 suction port on the compressor (See Lubricating O-rings, Page 11 and Photo 1, below). Tighten the connection fitting as shown in Lubricating O-rings, Page 11.

NOTE: The #6 and #8 A/C hoses are designated to be routed under the battery tray.

2. Locate the #8 condenser/compressor A/C hose. Lubricate (2) #8 O-rings, and connect the 90° fitting with service port to the #8 discharge port on the compressor (See Lubricating O-rings, Page 11 and Photo 1, below). With a properly lubricated #6 O-ring (See Lubricating O-rings, Page 11), connect the 90° fitting to the #8 condenser/core hardline coming from the core support (See Photo 2, below). Tighten each fitting connection as shown in Lubricating O-rings, Page 11.
3. Locate the #6 drier/evaporator A/C hose. Lubricate a #6 O-ring, and connect the 90° fitting to the drier hardline coming through the core support (See Lubricating O-rings, Page 11 and Photo 2, below). Tighten the connection fitting as shown in Lubricating O-rings, Page 11.
4. Install a #10 Adel clamp and use tie wraps to keep hoses away from pulleys and belts (See Photo 3, below).

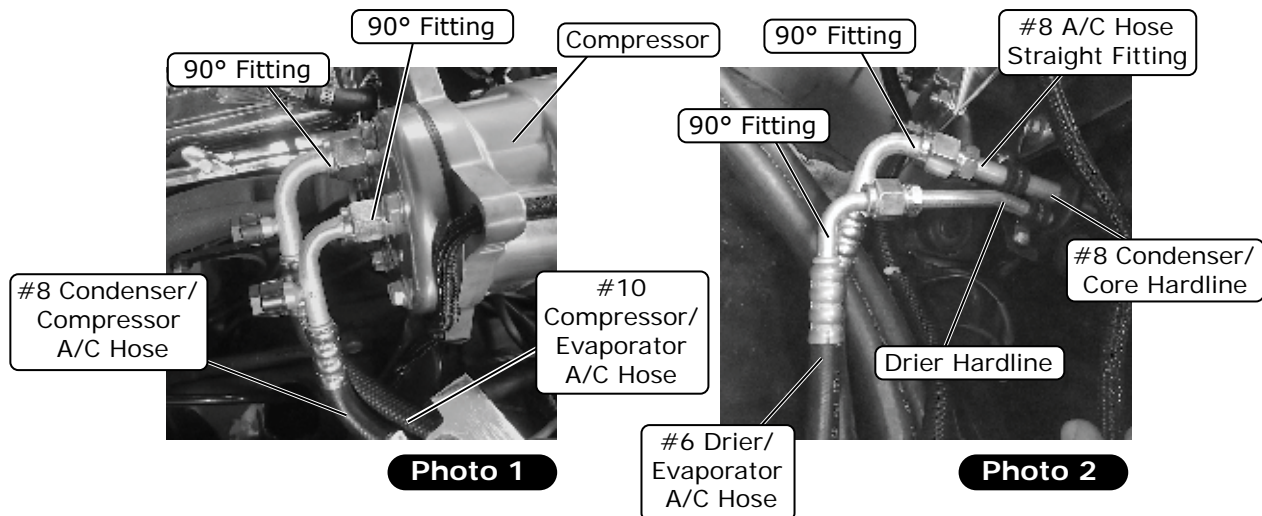

Photo 1

Photo 2

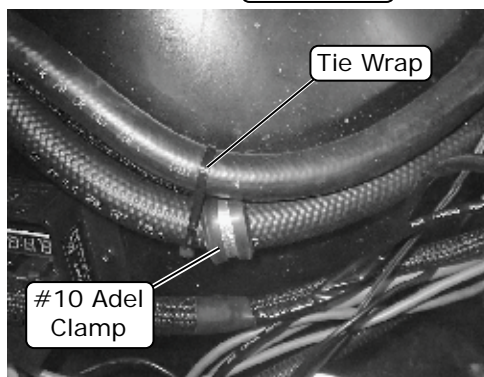

Photo 3



www.vintageair.com

Wiring Final Steps

1. Route all wiring toward the battery area.
2. Secure the blue lead from the main wiring harness to the #6 A/C hose with the supplied tie wraps.
3. Route the blue lead through the core support grommet toward the safety switch on the drier (See Photo 1, below).
4. Strip the blue lead and crimp the supplied 1/4" female terminal onto it. Connect the terminal to the safety switch on the drier (See Photo 2, below).
5. Connect the compressor bullet connector to the compressor lead (See Photo 3, below).
6. Route the compressor lead along the #8 A/C hose toward the core support grommet and secure the compressor lead with supplied tie wraps.
7. Route the compressor lead through the core support grommet toward the safety switch (See Photo 1, below).
8. Connect the terminal to the safety switch (See Photo 4, below).
9. Wrap the wiring with the supplied 1/4" Flexo sleeve and secure with tie wraps.
10. Reinstall the battery tray at this time.

Route blue lead through core support grommet toward safety switch



Photo 1

Crimp supplied 1/4" female terminal onto blue lead and connect terminal to safety switch on drier

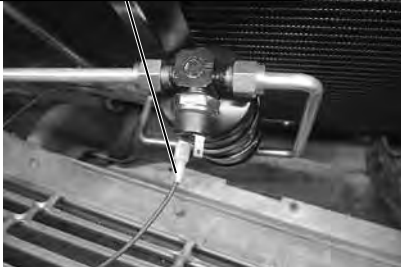

Photo 2

Connect compressor bullet connector to compressor lead



Photo 3

Connect terminal to safety switch



Photo 4



www.vintageair.com

Engine Compartment Wiring

NOTE: The following connections are critical to the performance of the system. Before making connections, refer to the Quality Crimp Guidelines, Page 31.

1. Route power and ground wires toward the battery (See Photo 1, below).
2. Install the supplied heat shrink over the 12 AWG orange standard fuse holder assembly wire and crimp it to the 12 AWG orange wire from the main wiring harness (See Photo 2, below). Slide the heat shrink over the crimp, then apply heat.
3. Install the supplied heat shrink over the 16 AWG black mini fuse holder assembly wire and crimp it to the 16 AWG red wire from the main wiring harness (See Photo 3, below). Slide the heat shrink over the crimp, then apply heat.
4. Install the fuses into the holders (See Photos 4 and 5, below).
5. Install the supplied heat shrink over the white ground wires, then crimp on the supplied ring terminals (See Photo 6, below). Slide the heat shrink over the crimps, then apply heat. **NOTE: Both white wires can be crimped to the larger ring terminal. Install the heat shrink, then strip the wires, twist them together and trim to length. Crimp on the ring terminal, then slide the heat shrink over and apply heat (See Photos 7 and 8, below).**



Route power and ground wires toward battery

Photo 1

Crimp 12 AWG orange fuse holder wire to 12 AWG orange wire from main wiring harness

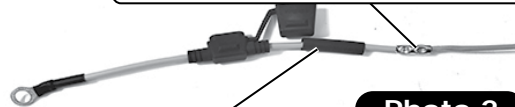

Photo 2

Install heat shrink over 12 AWG orange standard fuse holder assembly wire

Crimp 16 AWG black fuse holder wire to 16 AWG red wire from main wiring harness



Photo 3

Install heat shrink over 16 AWG black standard fuse holder assembly wire

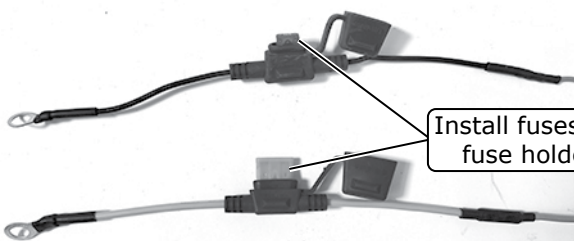

Install fuses into fuse holders

Photo 4



Both white ground wires can be crimped together. Install heat shrink, then strip wires, twist together and trim to length.

Photo 5

Install heat shrink over white ground wires, then crimp on ring terminals

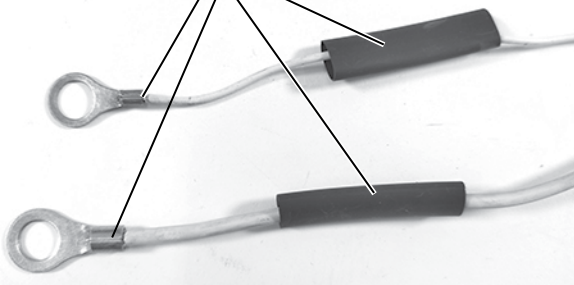

Photo 6



Photo 7

Crimp on ring terminal, then slide heat shrink over and apply heat



Photo 8



www.vintageair.com

Engine Compartment Wiring (Cont.)

6. Connect the ground wire ring terminals to the negative battery terminal connector (See Photos 9 and 10, below).
7. Connect the positive wire ring terminals to the positive battery terminal connector (See Photos 11 and 12, below). **NOTE: Do not connect power until the installation is completed.**
8. Wiring completed (See Photo 13, below).

Connect ground wire ring terminals to negative battery terminal
NOTE: Either connection application can be used.

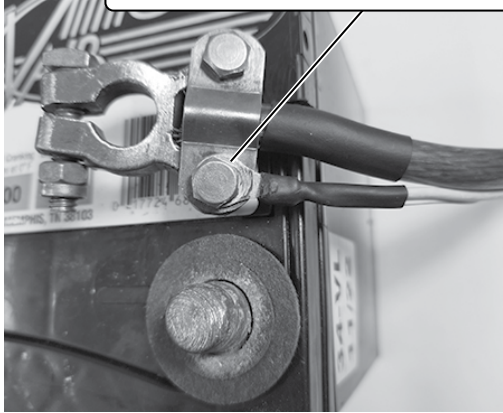

Photo 9

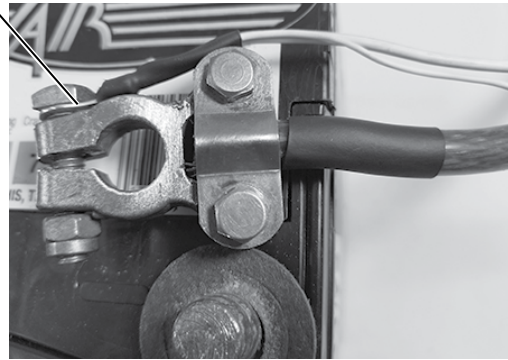

Photo 10

Connect power wire ring terminals to positive battery terminal
NOTE: Either connection application can be used.

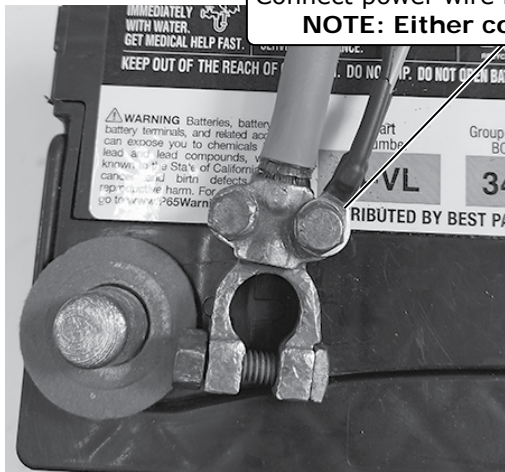
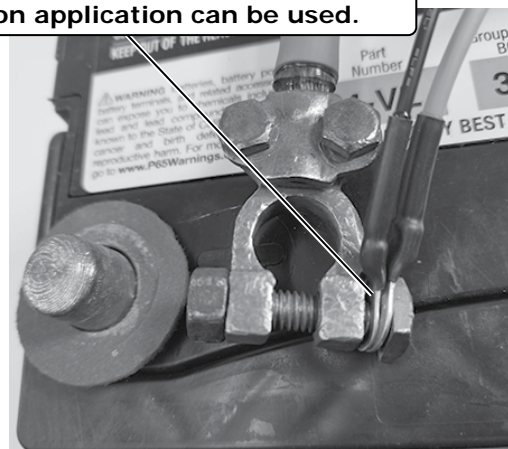

Photo 11



NOTE: Do not connect power until installation is completed.

Photo 12



Completed Installation Shown

Photo 13



www.vintageair.com

Glove Box Installation

On a workbench, perform the following:

1. Position the new glove box over the glove box opening in the dash bezel (See Photo 1, below). Mark the (4) mounting holes, then remove the glove box and drill (4) mounting holes using a 1/4" drillbit (See Photo 2, below).
2. Install (4) #8 U-nuts onto the glove box (See Photo 3, below).
3. Position the glove box in the dash opening.
4. Reinstall the dash bezel, and secure the glove box using (4) #8 x 1/2" wide head screws.

Position glove box over glove box opening



Photo 1

Drill (4) mounting holes using a 1/4" drillbit

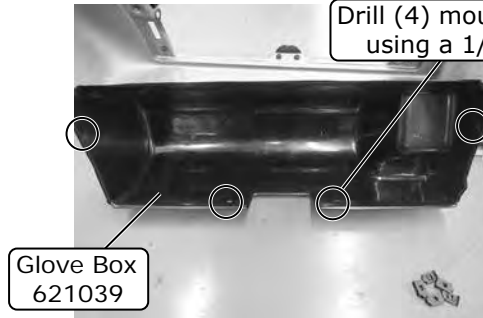

Photo 2

Install (4) #8 U-nuts onto glove box

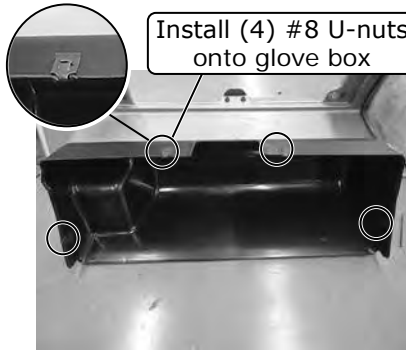

Photo 3

(4) #8 x 1/2" Wide Head Screws

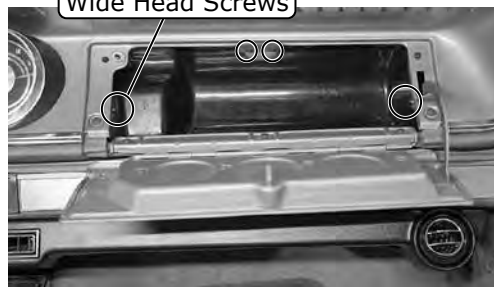

Photo 4



www.vintageair.com

Final Steps: Installation Check

| Installation Check | |
|--------------------------|---|
| ITEM TO CHECK | Procedure |
| <input type="checkbox"/> | <p>ECU</p> <p>If no blinking is observed after 1 minute of turning the ignition on, go to the next check.</p> <p>If repetitive blinking is observed, go to the Advanced Diagnostics Section to diagnose.</p> |
| <input type="checkbox"/> | <p>Blower speed control</p> <p>Set the blower speed control to OFF, <u>confirm that the blower is off</u>.</p> <p>Position the blower speed control to LOW then MEDIUM and then HIGH. <u>At each setting confirm that the blower speed increases</u>, do this by feeling for the amount of air coming from the unit and hearing the blower speed increase.</p> |
| <input type="checkbox"/> | <p>Mode control</p> <p>Set the MODE control to the DASH position. <u>Confirm that air is being blown at the dash vents</u>.</p> <p>Set the MODE control to the FLOOR position. <u>Confirm that air is being blown at the floor vents</u>.</p> <p>Set the MODE control to the DEFROST position. <u>Confirm that all air is being blown from the defrost vents</u></p> <p>If heater lines are installed:</p> <p>Set the MODE control to the DASH position. Set the TEMP control to the MAX HEAT position. <u>Confirm that HOT air is coming from the dash vents</u>.</p> |
| <input type="checkbox"/> | <p>Temperature control</p> <p>If system is charged:</p> <p>Set the TEMP control to the MAX COOL position. <u>Confirm that COLD air is coming from the dash vents</u>.</p> <p>Also <u>confirm that the compressor "clicks" on</u> when adjusting the TEMP control from the MAX HEAT position to the MAX COOL position.</p> |
| <input type="checkbox"/> | <p>AC Indicator (If applicable)</p> <p>While the MODE control is set to the DASH position, and the TEMP control is set to the MAX COOL/MIN HEAT position, <u>confirm that the blue AC Indicator light is on</u>.</p> |
| <input type="checkbox"/> | <p>Backlight (If applicable)</p> <p>If your control panel has backlight capabilities and has been wired, turn the dash lamp on and <u>confirm that the AC panel's legend is lit</u>.</p> |
| <input type="checkbox"/> | <p>Fittings</p> <p>Verify AC and Heater fittings are all tight.</p> |



www.vintageair.com

Final Steps: Completing the Install

1. Reinstall all previously removed items.
2. Fill radiator with at least a 50/50 mixture of approved antifreeze and distilled water. It is the owner's responsibility to keep the freeze protection at the proper level for the climate in which the vehicle is operated. Failure to follow antifreeze recommendations will cause heater core to corrode prematurely and possibly burst in A/C mode and/or freezing weather, voiding your warranty.
3. Double-check all fittings, brackets and belts for tightness.
4. Vintage Air recommends that all A/C systems be serviced by a licensed automotive A/C technician.
5. Evacuate the system for a minimum of 45 minutes prior to charging, and perform a leak check prior to servicing.
6. Charge the system to the capacities stated on Page 4 of this instruction manual.
7. See Operation of Controls procedures on Page 34.



www.vintageair.com

Duct Hose Routing

NOTE: For the system to function optimally, the duct hoses must be routed as directly as possible, taking care to avoid kinks, sharp bends and unnecessary length. Vintage Air supplies duct hoses in continuous lengths that will need to be cut to size depending on application. Before cutting, familiarize yourself with the installation instructions and verify the routing will work with your application. For custom hose routing, additional hose may be needed and can be purchased from Vintage Air.

1. Stretch the duct hose until there is no slack, measure, mark and cut hose to size (See Photo 1, below).

Stretch, measure, mark and cut hose to size



Photo 1

Disclaimer: Before cutting duct hose to length, verify the routing will work for your application.

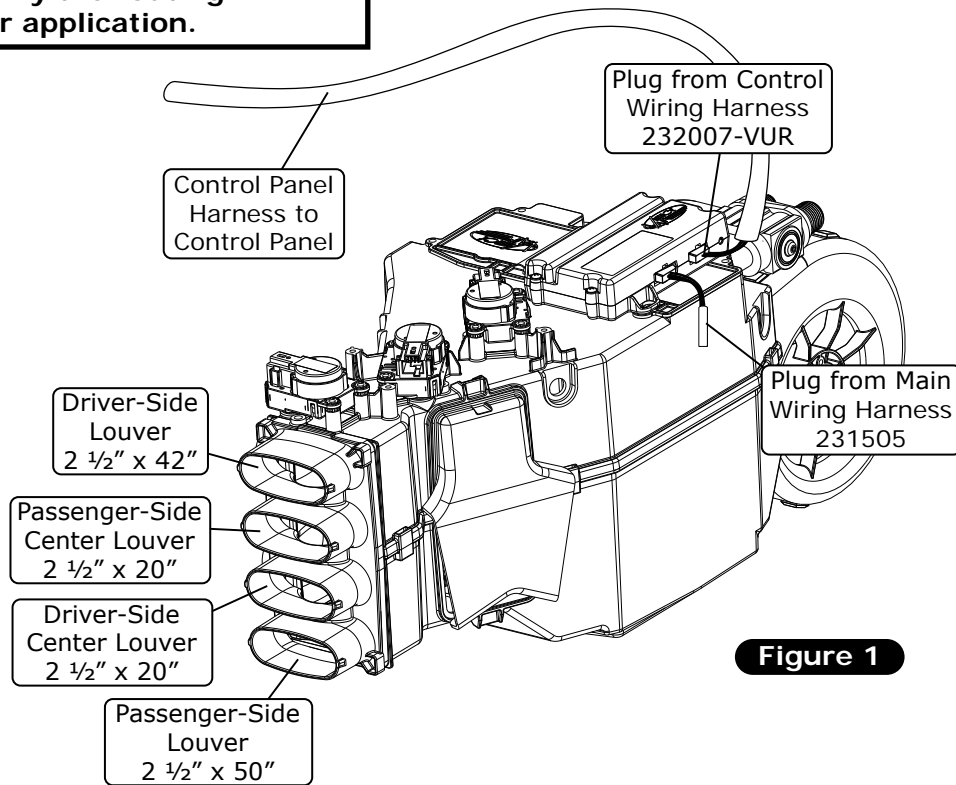
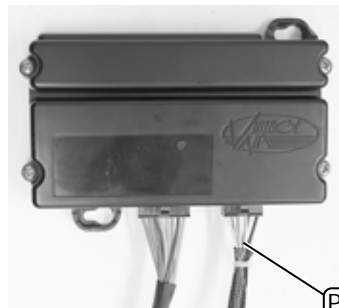

Figure 1



NOTE: ECU must be placed away from water and humidity, and also be accessible for servicing. If relocating, connectors must be positioned towards the bottom.

Position connectors towards bottom



www.vintageair.com

Quality Crimp Guideline

Acceptable strip length
(Some copper visible)

Crimped area is centered
on each side of splice

Bad strip length
(Too much copper visible)
Visible copper should be
just enough to ensure
clearance between splice
area and wire insulation

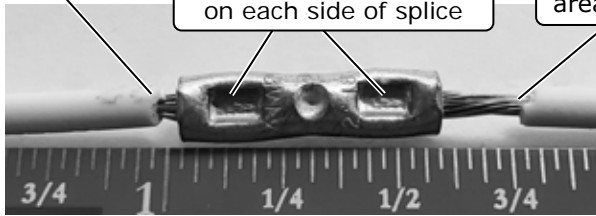

Photo 1

A good crimp requires
seam of butt splice to be
opposite of crimp die tooth



Photo 2

Good Ring Terminal Crimp Bad Ring Terminal Crimp



Photo 3

Crimp area is centered on barrel

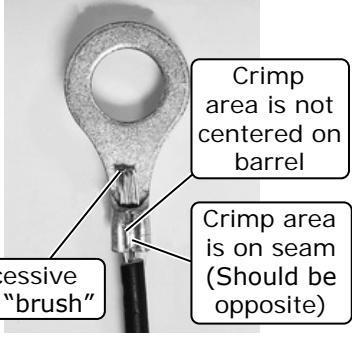

Photo 4

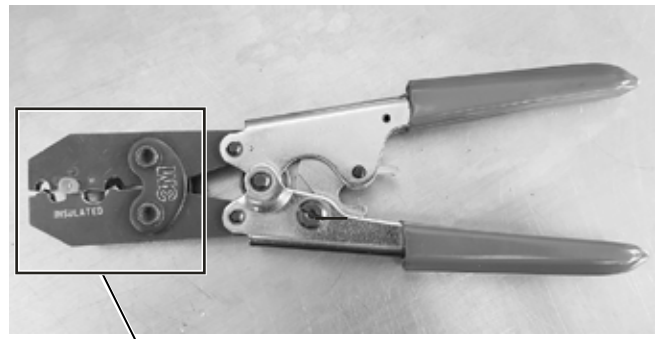

Photo 5

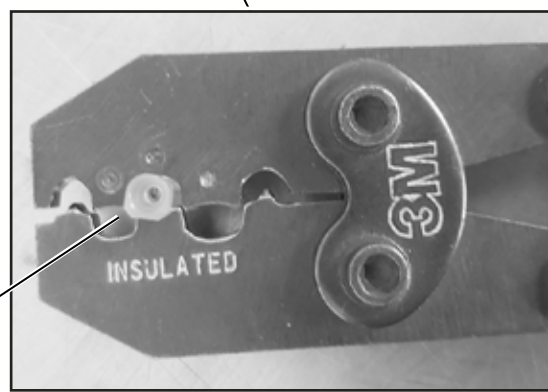

Photo 5a

Use a ratcheting crimp tool for insulated barrel terminals when crimping the provided female insulated terminal. Ensure terminal is inserted in appropriate position before crimping.



www.vintageair.com

Gen 5 Wiring Diagram

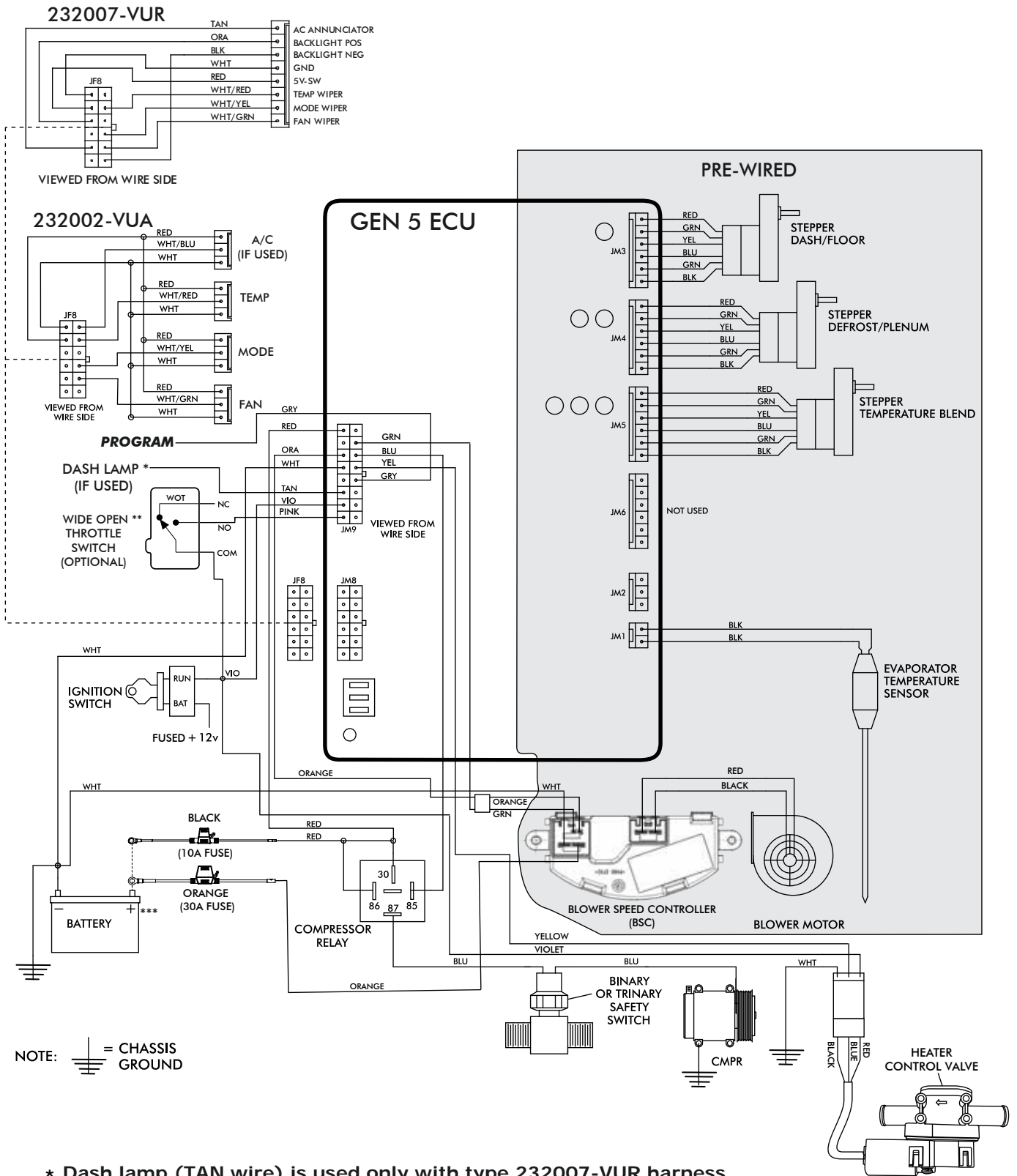

NOTE: = CHASSIS GROUND

- * Dash lamp (TAN wire) is used only with type 232007-VUR harness.
- ** Wide open throttle switch contacts close only at full throttle, which disables A/C compressor.
- *** Install fuse assemblies at or as near to the battery as possible.



www.vintageair.com

Gen 5 Wiring Instructions

WIRING HARNESS (231505) ↓

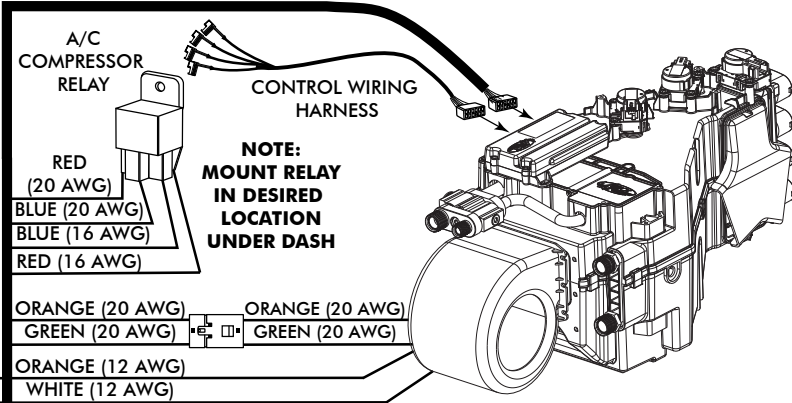

NOTE:
MOUNT RELAY
IN DESIRED
LOCATION
UNDER DASH

Ignition Switch:
Using provided butt splice (PN 226004), connect the 20 AWG violet wire to a 5A fused and switched 12V source such as Key On.

Wide Open Throttle Switch (Optional):
If a wide open throttle switch is required, connect the 20 AWG pink wire to a normally open switch that, when closed, connects a fused and switched 12V source to the pink wire. See Gen 5 wiring diagram for an example.

Dash Light (Optional):
If using a Vintage Air control panel with back light, connect the 20 AWG tan wire to the vehicle's dash back light 0-12V using provided butt splice (PN 226004).

WIRING HARNESS (232020) →

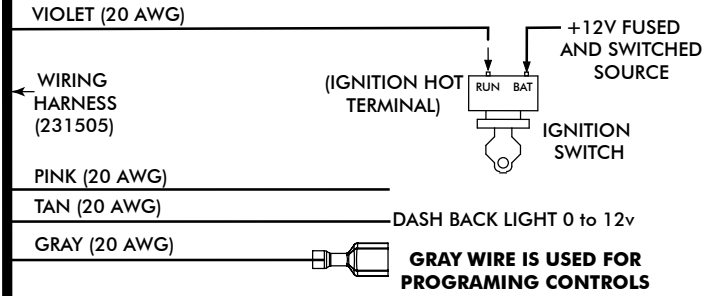

GRAY WIRE IS USED FOR PROGRAMING CONTROLS IF APPLICABLE

FIREWALL

FIREWALL

WIRING HARNESS (232020) →

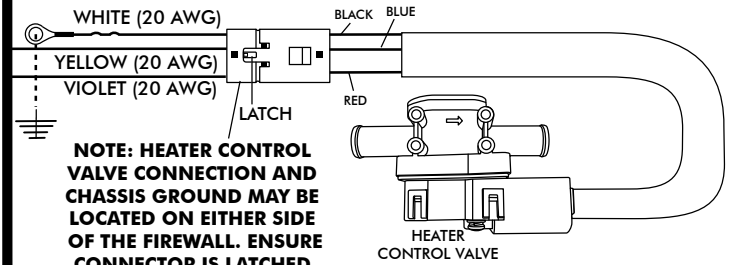

NOTE: HEATER CONTROL VALVE CONNECTION AND CHASSIS GROUND MAY BE LOCATED ON EITHER SIDE OF THE FIREWALL. ENSURE CONNECTOR IS LATCHED FIRMLY.

Heater Control Valve:
Connect the Violet/Yellow/White twisted branch with 3 position connector into the heater control valve connector. Ensure that the mating latch is fully seated.

Binary/Trinary & Compressor:
Binary Switch: Terminate provided insulated female terminal (PN 23172-VUW) to the blue 16 AWG wire. Connect as shown.
Trinary Switch: Connect according to trinary switch wiring diagram.

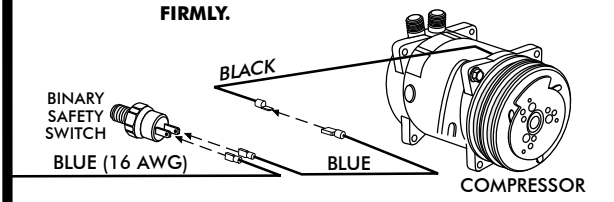

NOTE: CONNECT WHITE WIRES DIRECTLY TO (-) BATTERY TERMINAL

Battery Connections:
ECU Ground: Terminate provided ring terminal (PN 226110) to 20 AWG white wire from the 231505 wire assembly and install at battery.
ECU PWR: Terminate provided fuse assembly with black leads (PN 233012) to the 16 AWG red wire from the 231505 wire assembly. Install provided 10A Red Mini Fuse (PN 226118). Install at battery.
Blower Speed Controller (BSC) Ground: Terminate provided ring terminal (PN 226111) to 12 AWG white wire from the 232020 wire assembly and install at battery.
Blower Speed Controller (BSC) PWR: Terminate provided fuse assembly with orange leads (PN 233008) to the 12 AWG orange wire from the 232020 wire assembly. Install provided 30A Green ATO/ATC Fuse (PN 226125). Install at battery.

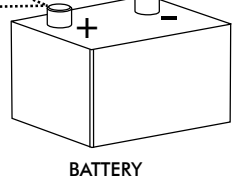



www.vintageair.com

Operation of Controls

On Gen IV or Gen 5 systems with three lever/knob controls, the temperature control toggles between heat and A/C operations. To activate A/C, move the temperature lever/knob all the way to cold and then back it off to the desired vent temperature. For heat operation, move the temperature lever/knob all the way to hot and then adjust to the desired vent temperature. The blower will momentarily change speed, each time you toggle in and out of heat and A/C operations, to indicate the change. **NOTE: For proper control panel function, refer to control panel instructions for calibration procedure.**

Blower Speed

This lever/knob controls blower speed, from OFF to HI.

Mode Control

This lever/knob controls the mode positions, from DASH to FLOOR to DEFROST, with a blend in between.

Temperature Control

This lever/knob controls the temperature, from HOT to COLD.

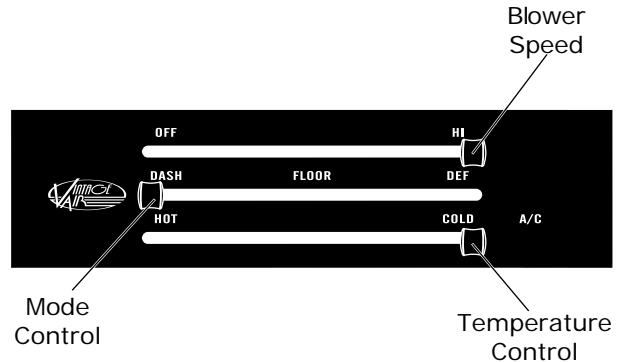

A/C Operation

Blower Speed

Adjust to desired speed.

Mode Control

Adjust to desired mode position (DASH position recommended).

Temperature Control

For A/C operation, adjust to coldest position to engage compressor (adjust between HOT and COLD to reach desired temperature).

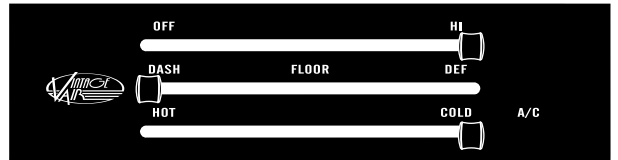

Heat Operation

Blower Speed

Adjust to desired speed.

Mode Control

Adjust to desired mode position (FLOOR position recommended).

Temperature Control

For maximum heating, adjust to hottest position (adjust between HOT and COLD to reach desired temperature).



Defrost/De-fog Operation

Blower Speed

Adjust to desired speed.

Mode Control

Adjust to DEFROST position for maximum defrost, or between FLOOR and DEFROST positions for a bi-level blend (Compressor is automatically engaged).

Temperature Control

Adjust to desired temperature.





www.vintageair.com

Troubleshooting Guide

This printed troubleshooting guide is our basic guide that covers common installation problems. To see our advanced diagnostics and troubleshooting guide, please refer to the following page for instructions on how to download the complete guide.

WARNING: While troubleshooting the system, never probe connector terminals from the front mating side, only back probe.

WARNING: While troubleshooting the system, never use automotive check lights.

| Symptom | Condition | Checks | Actions | Notes |
|---|--|--|--|--|
| 1. Blower stays on high speed with ignition on. | No other functions work. | Check for damaged pins or wires in the control panel wire assembly and mating header at ECU. | If found damaged, replace wire assembly or ECU. | If fuse continues to blow, there is a serious problem in the wiring. Check all wiring and ensure the wire is not damaged and shorting out along its route. |
| | All other functions work. | Check for a bad ECU GND. Check for damaged pins or wires in the control panel wire assembly and mating header at ECU. Check if Blower power fuse is blown. Check for a bad ECU GND. | If found damaged, replace wire assembly or ECU. Replace fuse. Repair connection. | |
| 2. Compressor will not turn on (All other functions work). | System is not charged. | System must be charged for compressor to engage. | Charge system. | Danger: Never bypass safety switch with engine running. Serious injury can result. |
| | System is charged. | Check for faulty A/C potentiometer or associated wiring (not applicable to 3-pot controls). | Check continuity to ground on white control head wire. Check for 5V on red control head wire. | To check for proper pot function, check voltage at white/red wire. Voltage should be between 0V and 5V, and will vary with pot lever position. |
| | | Check for disconnected or faulty thermistor. | Check 2-pin connector at ECU housing. | Disconnected or faulty thermistor will cause compressor to be disabled. |
| 3. Compressor will not turn off (All other functions work). | Compressor will not turn off (All other functions work). | Check for faulty A/C potentiometer or associated wiring. | Repair or replace pot/control wiring. | Red wire at A/C pot should have approximately 5V with ignition on. White wire will have continuity to chassis ground. White/Red wire should vary between 0V and 5V when lever is moved up or down. |
| | | Check for faulty A/C relay. | Replace relay. | |



www.vintageair.com

Troubleshooting Guide (Cont.)

| Symptom | Condition | Checks | Actions | Notes |
|---|--|--|---|--|
| 4. System will not turn on, or runs intermittently. | Works when engine is not running; shuts off when engine is started | Noise interference from either ignition or alternator. | Install capacitors on ignition coil and alternator. Ensure good ground at all points. Relocate coil and associated wiring away from ECU and ECU wiring. Check for burned or loose plug wires. | Ignition noise (radiated or conducted) will cause the system to shut down due to high voltage spikes. If this is suspected, check with a quality oscilloscope. Spikes greater than 16V will shut down the ECU. Install a radio capacitor at the positive post of the ignition coil (see radio capacitor installation bulletin). A faulty alternator or worn out battery can also result in this condition. |
| | Will not turn on under any conditions. | Verify connections on power lead, ignition lead, and both white ground wires. Verify battery voltage is greater than 10 volts and less than 16 while engine is running. | Check for power at ECU, and confirm ignition is being applied to ECU properly. Verify proper meter function by checking the condition of a known good battery. | |
| 5. Loss of mode door function. | No mode change at all. | Check for damaged mode switch or potentiometer and associated wiring. | | |
| | Blower turns on and off rapidly. | Battery voltage is at least 12V. Battery voltage is less than 12V. | Ensure all system grounds and power connections are clean and tight. Charge battery. | System shuts off blower at 10V. Poor connections or weak battery can cause shutdown at up to 11V. |
| 7. Erratic functions of blower, mode, temp, etc. | | Check for damaged switch or pot and associated wiring. | Repair or replace. | |

Advanced Diagnostics and Troubleshooting Guide

If after referencing the Troubleshooting Guide, the issue is not resolved, move to The Advanced Diagnostics and Troubleshooting Guide that covers the following:

- ECU Diagnostics Codes
 1. ECU Blink Sequence
 2. Firmware Version Number
 3. ECU Model Number
 4. ECU Start-Up Blink Sequence
 5. Diagnostic Codes
- Complete Advanced Troubleshooting Guidelines

Access the latest version of the Advanced Diagnostics and Troubleshooting Guide by scanning the following QR code on your mobile device:



You can also access the guide by typing the following address into your web browser:

https://www.vintageair.com/instructions_pdf/905000.pdf



www.vintageair.com

Packing List: Evaporator Kit (561358)

| No. | Qty. | Part No. | Description |
|-----|------|----------|--------------------------------------|
| 1. | 1 | 765225 | Gen 5 Magnum Max Module with 444 ECU |
| 2. | 1 | 781358 | Accessory Kit |

Checked By: _____
Packed By: _____
Date: _____

1

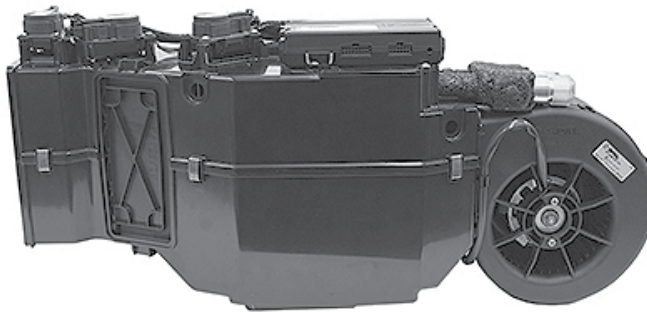

Gen 5 Magnum Max
Module with 444 ECU
765225

2

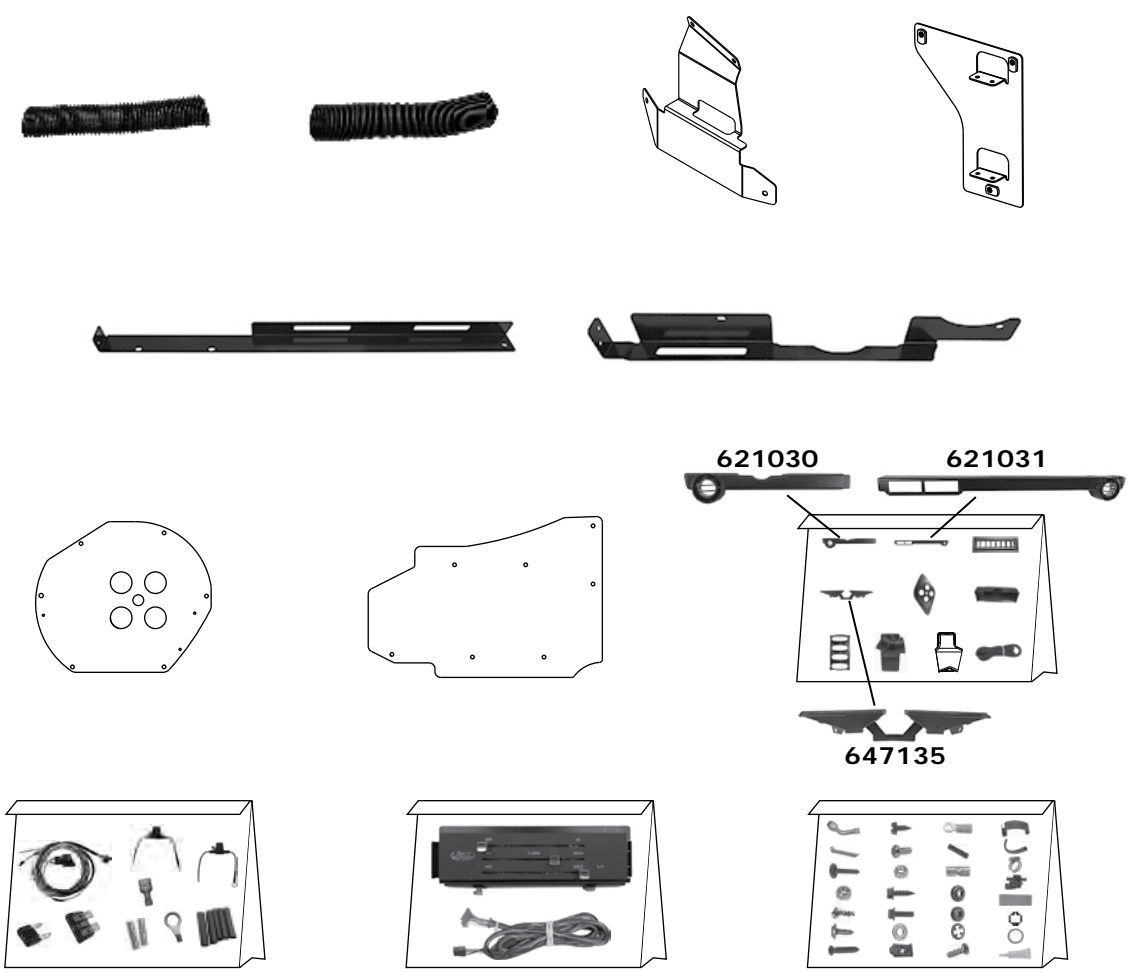

Accessory Kit
781358

**NOTE: Images may not depict actual parts and quantities.
Refer to packing list for actual parts and quantities.**